



# Mixxx User Manual

*Release 2.3.0*

**The Mixxx Development Team**

10 gen 2022

|          |  |           |
|----------|--|-----------|
| <b>1</b> | <b>Introduzione a Mixxx</b>  | <b>1</b>  |
| 1.1      | How Mixxx Works . . . . .  | 1         |
| <b>2</b> | <b>Getting Started</b>   | <b>4</b>  |
| 2.1      | Installing Mixxx . . . . .   | 4         |
| 2.2      | Upgrading Mixxx . . . . .  | 4         |
| 2.3      | Opening Mixxx . . . . .  | 5         |
| 2.4      | Importing your audio files . . . . .                               | 5         |
| 2.5      | Analyze your library . . . . .                                     | 6         |
| 2.6      | Configuring sound input and output . . . . .                       | 6         |
| <b>3</b> | <b>The Mixxx User Interface</b>                                    | <b>9</b>  |
| 3.1      | Skin Settings . . . . .  | 10        |
| 3.2      | Decks . . . . .  | 10        |
| 3.3      | Mixer . . . . .  | 21        |
| 3.4      | Samplers . . . . .   | 26        |
| 3.5      | Effects . . . . .  | 28        |
| 3.6      | Microphones & Auxiliary Inputs . . . . .                           | 28        |
| 3.7      | Preview Deck . . . . .   | 29        |
| <b>4</b> | <b>The Mixxx Library</b>   | <b>30</b> |
| 4.1      | Overview of the Library features . . . . .                         | 30        |
| 4.2      | Tracks - View and edit your whole collection . . . . .             | 31        |
| 4.3      | Loading Tracks . . . . .   | 34        |
| 4.4      | Finding Tracks (Search) . . . . .                                  | 35        |
| 4.5      | Previewing Tracks . . . . .  | 37        |
| 4.6      | Edit metadata of audio files . . . . .                             | 37        |
| 4.7      | Auto DJ - Automate your mix . . . . .                              | 40        |
| 4.8      | Playlists - Arranging tracks in a set order . . . . .              | 41        |
| 4.9      | Crates - Organizing tracks into collections . . . . .              | 42        |
| 4.10     | Computer - Loading tracks from anywhere on your computer . . . . . | 43        |
| 4.11     | Recordings . . . . .   | 43        |
| 4.12     | History - Keep track of your sessions . . . . .                    | 43        |
| 4.13     | Analyze - Prepare your tracks . . . . .                            | 44        |
| 4.14     | Using libraries from other software . . . . .                      | 44        |
| 4.15     | Removing tracks from the library . . . . .                         | 46        |
| 4.16     | Compatible file formats . . . . .                                  | 47        |



|           |  |           |
|-----------|--|-----------|
| 4.17      | Music from audio CDs                                     | 48        |
| <b>5</b>  | <b>DJ Hardware</b>                                       | <b>49</b> |
| 5.1       | Controllers  | 50        |
| 5.2       | Audio Interfaces   | 50        |
| 5.3       | Mixers   | 52        |
| 5.4       | Turntables   | 53        |
| 5.5       | CDJs   | 53        |
| 5.6       | Microphones  | 53        |
| 5.7       | Headphones   | 53        |
| 5.8       | Splitter Cables  | 54        |
| <b>6</b>  | <b>Example Setups</b>                                    | <b>55</b> |
| 6.1       | Computer Only  | 55        |
| 6.2       | Laptop and Splitter Cable                                | 57        |
| 6.3       | Laptop and External USB Audio Interface                  | 57        |
| 6.4       | Laptop and MIDI or HID Controller                        | 58        |
| 6.5       | Laptop, External Hardware Mixer and Vinyl Control        | 59        |
| <b>7</b>  | <b>Controlling Mixxx</b>                                 | <b>61</b> |
| 7.1       | Using a Mouse and Touchpad                               | 61        |
| 7.2       | Using a Keyboard   | 62        |
| 7.3       | Using MIDI/HID Controllers                               | 63        |
| 7.4       | Using Timecode Vinyl Records and CDs                     | 65        |
| <b>8</b>  | <b>Controllo Vinile</b>                                  | <b>66</b> |
| 8.1       | How does it work?  | 66        |
| 8.2       | What do I need to use it?                                | 66        |
| 8.3       | Configuring Input and Output devices                     | 69        |
| 8.4       | Configuring Vinyl Control                                | 69        |
| 8.5       | Enabling Vinyl Control                                   | 72        |
| 8.6       | Single Deck Control                                      | 72        |
| 8.7       | End-Of-Record Mode                                       | 73        |
| 8.8       | Control Track  | 73        |
| 8.9       | Risoluzione dei problemi                                 | 73        |
| <b>9</b>  | <b>Using Microphones</b>                                 | <b>75</b> |
| 9.1       | Software Monitoring                                      | 75        |
| 9.2       | Direct Monitoring  | 76        |
| 9.3       | Hardware Mixers  | 78        |
| 9.4       | DJ Controllers With Microphone Inputs                    | 79        |
| 9.5       | Microphone Ducking                                       | 80        |
| <b>10</b> | <b>Live Broadcasting - Start your own Internet radio</b> | <b>81</b> |
| 10.1      | Streaming Servers  | 81        |
| 10.2      | Configuring Mixxx  | 82        |
| 10.3      | Troubleshooting  | 85        |
| <b>11</b> | <b>Effetti</b>   | <b>86</b> |
| 11.1      | Effect Units   | 86        |
| 11.2      | Effect Parameters & Metaknobs                            | 87        |
| 11.3      | Effect Unit Mix Modes                                    | 88        |
| 11.4      | Effects In Headphones                                    | 89        |
| 11.5      | Controller Effects Mapping                               | 89        |

|   |            |
|---|------------|
| <b>12 DJing Con Mixxx</b>   | <b>90</b>  |
| 12.1 Impostazione dei Livelli Propriamente (Guadagno Staging)   | 90         |
| 12.2 Beatmatching e missaggio   | 91         |
| 12.3 Master Sync  | 92         |
| 12.4 Mixaggio armonico  | 92         |
| 12.5 Registrare il tuo mix  | 92         |
| 12.6 Intro and Outro Cues   | 93         |
| 12.7 Auto DJ  | 95         |
| <b>13 Preferenze</b>  | <b>100</b> |
| 13.1 Hardware Audio   | 100        |
| 13.2 Libreria   | 103        |
| 13.3 Colors   | 104        |
| 13.4 Riconoscimento Beat  | 105        |
| 13.5 Rilevamento della chiave   | 106        |
| 13.6 Equalizzatori  | 107        |
| <b>14 Argomenti Avanzati</b>  | <b>109</b> |
| 14.1 Con diverse dozzine di controller DJ supportati immediatamente, Mixxx offre un controllo hardware completo per i tuoi mix DJ, vedi: ref: <i>control-midi</i> . | 109        |
| 14.2 Making a Custom Keyboard Mapping   | 111        |
| 14.3 Additional Effects via external Mixer Mode   | 111        |
| 14.4 Deleting Your Library  | 113        |
| <b>15 Contributing to the Project</b>   | <b>115</b> |
| 15.1 As a non-developer   | 115        |
| 15.2 As a software developer  | 116        |
| <b>16 Appendix</b>  | <b>117</b> |
| 16.1 Keyboard mapping table   | 117        |
| 16.2 Application shortcuts  | 119        |
| 16.3 Launching Mixxx from the Command Line  | 120        |
| 16.4 Developer tools  | 122        |
| 16.5 Mixxx Controls   | 122        |
| 16.6 The Mixxx Settings Directory   | 178        |
| 16.7 Additional Resources   | 179        |
| 16.8 Changelog  | 179        |
| <b>17 Hardware Manuals</b>  | <b>194</b> |
| 17.1 Controllers  | 194        |
| <b>18 Glossario dei Termini</b>   | <b>480</b> |
| <b>Control Index</b>  | <b>486</b> |
| <b>Indice</b>   | <b>502</b> |

Mixxx enables you to perform live DJ mixes with your digital music collection. It helps you rock the party with DJ controllers, vinyl turntables, or even just your keyboard. It is developed by an international team of volunteers who want to bring the joy of DJing to everyone. The project is non-profit, open-source and community driven. Together, we aim to build the best DJ software ever created. We hope you will *join us!*

## 1.1 How Mixxx Works

Mixxx is different from typical music player applications because it plays multiple audio files at the same time and has many features to manipulate the playback of the audio files. This lets you creatively mix different tracks together on the fly.

You can use Mixxx to preview the next track in headphones before the audience hears it, also known as headphone cueing. This helps you choose a track that is appropriate for the present moment and that will mix well into the currently playing track(s). To use headphone cueing, you need at least 2 separate audio outputs, typically provided by a USB audio interface (also known as a “sound card”, although most of them are not shaped like cards anymore).

The *shortcut* for headphone cueing in Deck1 is T while for Deck 2 the shortcut is Y.

Mixxx can be used in two different ways for headphone cueing:

### Internal Mixing

Mixxx plays multiple audio files on the computer at the same time, mixes them together, and sends the mixed signal to one audio interface output. A separate signal is sent to another audio interface output for headphone cueing. Often a DJ controller is used with internal mixing to provide easier control over Mixxx than a mouse and keyboard.

### External Mixing

In this kind of setup, Mixxx plays multiple audio files on the computer at the same time and sends each track to a separate audio interface output. The audio interface’s outputs are plugged into an external hardware mixer. The hardware mixer performs the actual mixing of the audio signals. On the hardware mixer, there are separate outputs for the mixed signal to play to the audience and for the DJ to use headphone cueing.

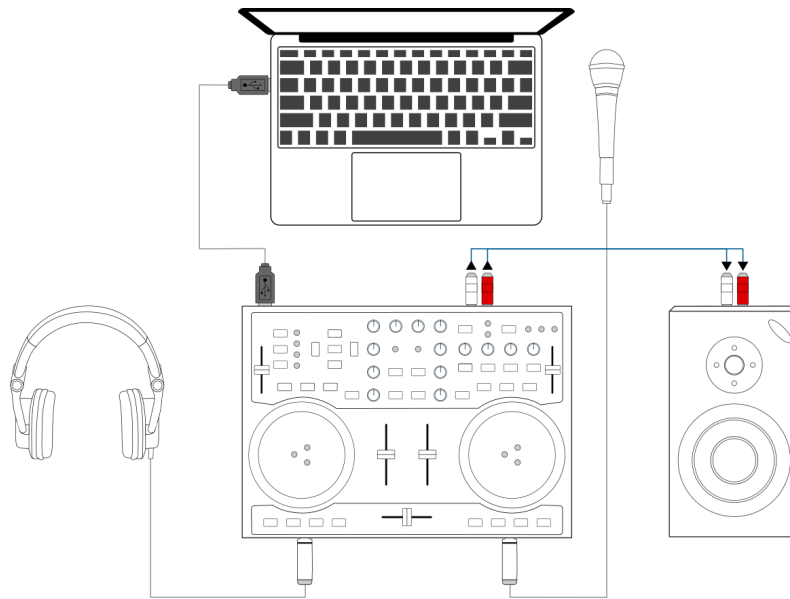

Figure1: Using Mixxx together with a DJ controller for internal mixing. The DJ controller has an integrated audio interface that provides two separate stereo outputs.

External mixing is typically used with turntables and *special vinyl records* to manipulate digital music files as if the music was on the vinyl records.

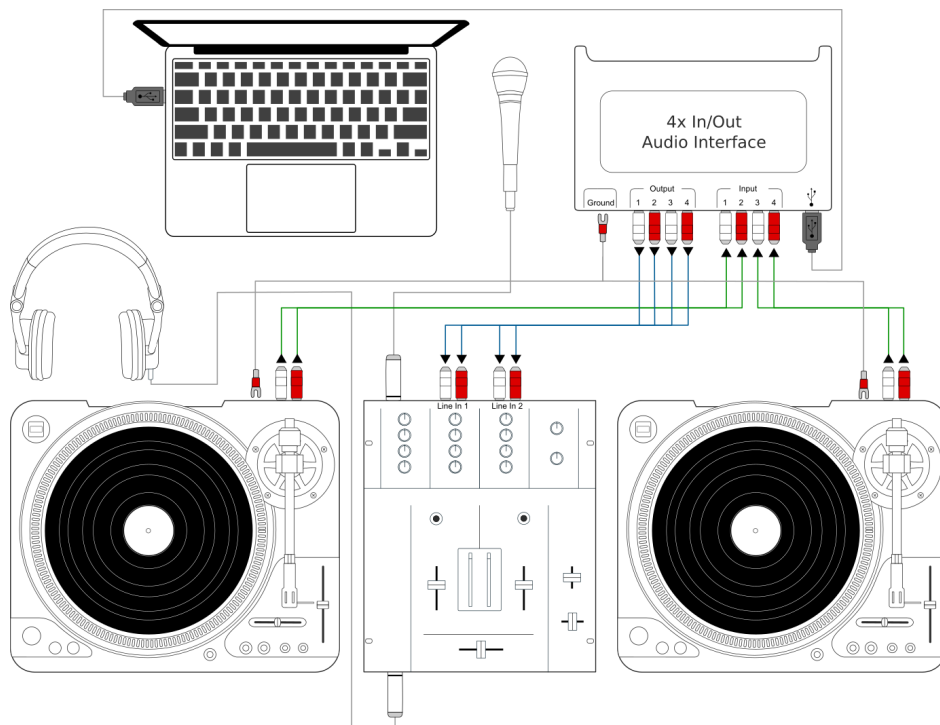

Figure2: Using Mixxx together with a USB audio interface, external mixer, and timecode vinyl for external mixing

### 2.1 Installing Mixxx

After downloading Mixxx from our Website, you need to install it on your computer.

**Windows** Double-click the Mixxx installation file and go through the installation wizard.

**macOS** Double-click the Mixxx .dmg file and drag the Mixxx icon to your Applications folder.

**GNU/Linux** No steps are necessary after you follow the instructions on the download page.

### 2.2 Upgrading Mixxx

You may safely install Mixxx on top of any previous version. You don't need to uninstall the old version.

Your settings and library will not be removed or reset, but they may be upgraded when you launch the new version of Mixxx. Note that we do not guarantee that new configurations will work on older versions of Mixxx, therefore you may want to make a backup of your existing settings just in case.

**Windows**

Mixxx settings are in `%LOCALAPPDATA%\Mixxx`, which is usually something like `c:\Users\\AppData\Local\Mixxx`. If you have trouble finding this folder, see [these instructions](#).

**macOS** Mixxx settings are in `/Users/<username>/Library/Containers/org.mixxx.mixxx/Data/Library/Application Support/Mixxx`

**GNU/Linux** Mixxx settings are in `/home/<username>/.mixxx`

Copy this directory to a backup drive or somewhere else on your system to make a backup of your settings.

**Vedi anche:**

For detailed descriptions of the settings files, go to [The Mixxx Settings Directory](#).

## 2.3 Opening Mixxx



Once you've installed Mixxx, start by opening Mixxx and importing your music to the Mixxx library.

**Windows** Double-click the Mixxx icon on the Desktop. Alternatively, browse your Windows start menu and click the Mixxx icon, or perform a search for `Mixxx.exe`.

**macOS** Double-click the Mixxx icon in the Applications folder. Alternatively, drag the Mixxx icon to the dock and double-click it there or search for `mixxx` in Spotlight.

**GNU/Linux** Click the Mixxx icon in the applications menu or launcher of your desktop environment or perform a search for `mixxx`. Alternatively type `mixxx` into the terminal, then hit Return. If your *audio interface* is not accessible from Mixxx because it is used by other applications via PulseAudio, you may close and restart Mixxx using `pasuspender mixxx`. See *Launching Mixxx from the Command Line* for an overview of Mixxx's command line options.

## 2.4 Importing your audio files

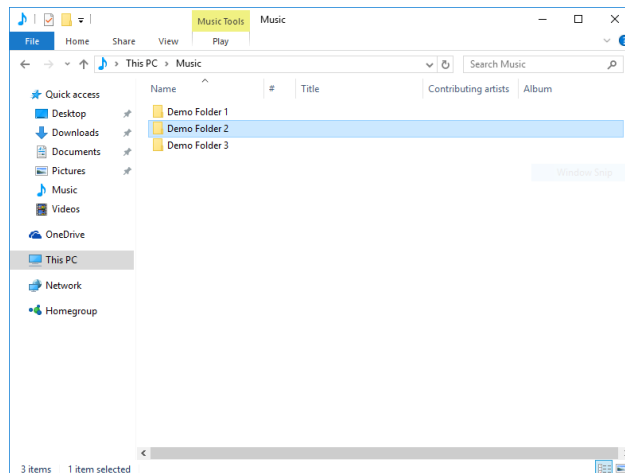

Figure1: Mixxx running on Windows 10 - Choose music library directory dialog

The first time you run Mixxx, you are asked to select a directory where your music is stored. By default, the dialog points to a location where music files are typically held, but you can select any location on your computer.

Click *Select Folder* and Mixxx will scan your music library. Depending on the size of your library this could take some time. All the supported music files Mixxx detects will be listed in the *Tracks - View and edit your whole collection*.

If you want to refresh your library (for example because you added or moved files), you can do this with *Library ▶ Rescan Library* in the menu. If you want to rescan at every launch, select *Preferences ▶ Library ▶ Rescan on startup*.

**Avvertimento:** On Windows 7 and 8 the import dialog points to your Windows “Music“ Library, a special-purpose virtual folder. You can **not** use these virtual folders. Select a regular folder instead, usually “My Music“, like pictured above.

## 2.5 Analyze your library



Mixxx automatically analyzes tracks the first time you load them in a deck. This allows you to run *beatgrid*, *key*, and *ReplayGain* detection on tracks in advance. It also prepares the waveform overviews, detects file corruption, and calculates the *BPM* values.

### Vedi anche:

For more information, go to *Riconoscimento Beat*.

### 2.5.1 Why you should analyze your audio files

If the tracks have never been played with Mixxx before, the library columns *BPM*, *Duration* and *Key* will be empty or unreliable (because the values are just read from the file's tags if present and might be wrong). Pre-generating beatgrids gives you the chance to double-check the beat markers to make sure they are correct. Errors in beatgrids can cause difficulty when syncing tracks. Furthermore, track analysis takes considerable CPU power and might cause skips in the audio — things you surely don't need while performing.

### 2.5.2 How to analyze your audio files

Once you have *imported your music library*, press *OK* on the Preferences window.

- Go to the *Analyze* view on the left side panel of the library.
- To analyze a few specific tracks, hold down the `Ctrl` button, and select the tracks that you want to analyze or you can `shift`-select a range of tracks. Once they've been highlighted, click the *Analyze* button on the top right of the library section.
- To analyze the newly added tracks, toggle the *New* label and then click *Analyze*.
- To analyze the entire library, toggle the *All* label and then click *Analyze*.
- The *New* and *All* toggle buttons are located at the top left of the analysis pane - just above the *Preview* and *Cover Art* column titles of the library.

While analyzing, the progress in percentage and total queue length are shown.

## 2.6 Configuring sound input and output

Before you can start using Mixxx, you need to configure Mixxx to use your sound hardware in *Preferences* ▶ *Sound Hardware*. You do not need to configure all inputs and outputs.

The *DJ Hardware* chapter explains different types of DJ hardware and how to set them up with the input and output options. For Mixxx to perform the best it can on your system, configure the other *Hardware Audio* preferences in addition to the inputs and outputs.



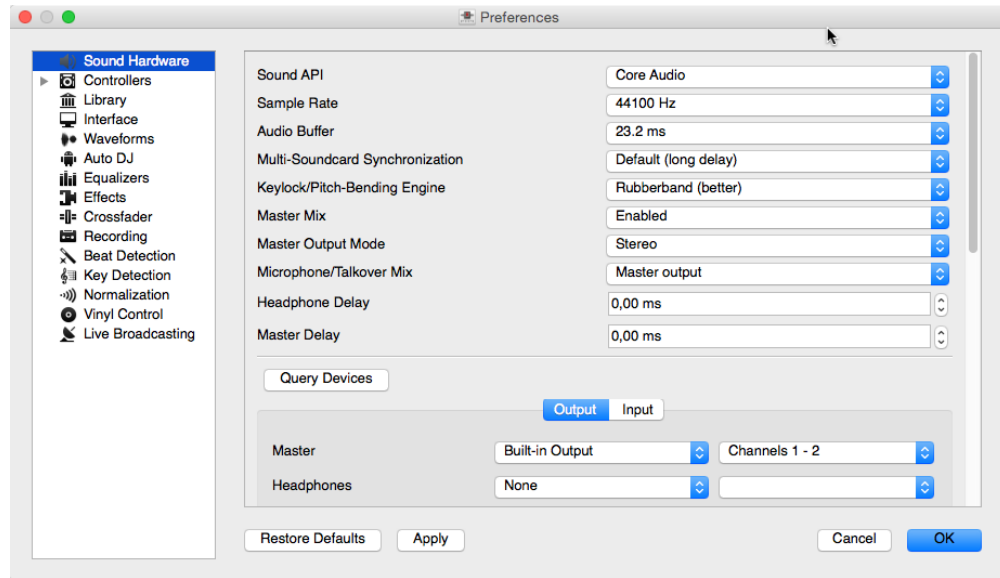

Figure2: Mixxx Sound Hardware Preferences

## 2.6.1 Output Options

### Internal mixing:

Use these outputs if you are not using an *external hardware mixer*. If you are using a controller with a built-in audio interface, use these outputs.

- *Master*: all decks, samplers, microphones, and auxiliary inputs mixed together. This output is sent to the speakers for the audience.
- *Headphones*: all decks, samplers, microphones, and auxiliary inputs assigned to *pre-fader listening*
- *Booth*: same as Master output, but has a separate gain control

### External mixing:

- *Decks 1-4*: the individual unmixed decks to send to an external mixer
- *Bus Left/Center/Right*: all decks, samplers, and auxiliary inputs assigned to each side of Mixxx's *crossfader*

## 2.6.2 Input Options

### Internal mixing:

Use these inputs if you are not using an external hardware mixer. If you are using a controller with a built-in audio interface, use these inputs.

- *Microphone 1-4*: live microphone or musical instrument inputs
- *Auxiliary 1-4*: other sound sources

### External mixing:

- *Record/Broadcast*: When this is configured, Mixxx will record and broadcast from this audio interface input instead of the internal master mix. If you have a microphone plugged into the mixer, do not configure the Microphone 1-4 inputs.

### Either internal or external mixing:

- *Vinyl Control 1-4*: timecode input from turntables or CDJs for manipulating decks 1-4

**Vedi anche:**

*Using Microphones*

## The Mixxx User Interface

Welcome to the Mixxx interface. This is where the magic happens. You are going to want to get very familiar with this interface because it is the main way to use Mixxx. In this chapter, we present the default interface of Mixxx and describe its elements, knobs and faders.



Figure1: The Mixxx interface - Latenight skin

This is the LateNight skin, PaleMoon color theme. It is the default skin supplied with Mixxx 2.3. There are a variety of

other skins included with Mixxx. You should explore them all to figure out which one you prefer. This section will focus on LateNight only, though all Mixxx skins provide most of the controls described here.

## 3.1 Skin Settings

On top, and on the right side of the user interface are the section expansion buttons and options.



Figure2: The GUI section quick toggles buttons in the top tool bar

If you click on either *WAVEFORMS*, *4 DECKS*, *MIXER*, *EFFECTS*, *SAMPLERS* or *MICS & AUX* then you will enable control sections for interacting with:

- *Waveform Displays*
- *Decks*
- *Mixer*
- *Effects*
- *Samplers*
- *Microphones & Auxiliary Inputs*

You can also use the specific *Application shortcuts*.

Click the *SETTINGS* button or gear icon (depending on the skin) to open the skin settings menu. This provides common basic controls as well as some skin-specific options.

## 3.2 Decks

The deck section comes in three sizes: Full, Compact and Mini. You can switch between any of the three sizes by clicking on the *Settings* button or the gear icon. Under the *Decks* section, click on «hide mixer to select». This will automatically select the Compact deck (underlined and bolded). If you wish to change to a different deck size, you can choose FULL or Mini.

The FULL deck (which is similar in all skins) will show the *Vinyl Control Mode and Cueing controls* and *Key controls* at the top of the deck section and then the *Hotcue Controls, Intro/Outro Markers, Loop Controls* at the bottom.

The Compact deck has a reduced set of controls for when you don't need all of them on screen, for example when they're also accessible from your controller. Reverse is removed from the *Playback/Cue Controls*, and the *Hotcue Controls, Intro/Outro Markers, Loop Controls* and rate adjust buttons are not shown.

The mini deck is of a much smaller size and shows only the waveform and the *Track Information Display*. You can also use minimal decks with the maximized library.

---

**Suggerimento:** Hiding the mixer will by default switch to the compact decks.

---

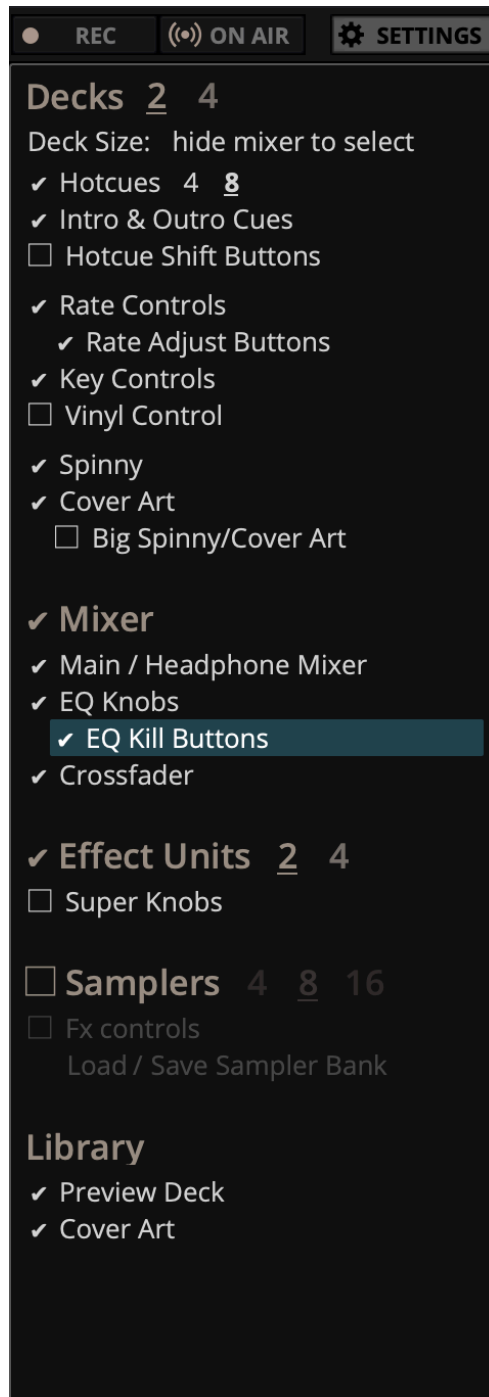

Figure3: The Skin Settings menu on the right

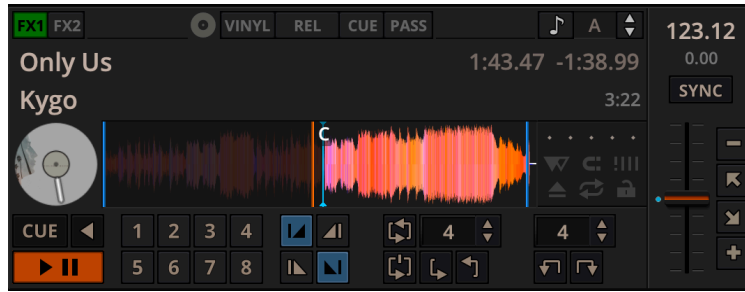

Figure4: A deck with a track loaded

The deck section allows you to control everything relating to a virtual turntable *deck*. We are going to break this down into sections.

### 3.2.1 Track Information Display



Figure5: The track information section of the deck

**Track Title** The title of the track that was loaded into a deck is displayed on top. This is the same as the title listed under the *Title* column heading in the *Mixxx library*. This information is initially loaded from the track's *metadata*. If the metadata is missing, the title and artist are guessed from the filename.

**Track Artist** The artist of the track is listed below. It is the same as listed under the *Artist* column heading in the *Mixxx library*.

**Time Elapsed/Remaining/Both** By default it displays the total elapsed time in the track up to the millisecond. Clicking on the display switches to the *Time Remaining* view, which indicates how much time is left before the track reaches the end. Clicking the display again, both the elapsed and remaining time are shown simultaneously in the format *elapsed time / remaining time*. You can change the default in *Preferences > Decks > Deck options*.

**BPM (Tempo)** The number at the top right is the effective *BPM* of the track. This is the detected *BPM* of the track, adjusted for the playback rate of the track. For example, if the track is normally 100 BPM, and it is playing at +5%, then the effective BPM will read 105 BPM.

---

**Suggerimento:** You can use a keyboard shortcut and tap with the beat to set the BPM to the speed you are tapping, go to *Using a Keyboard* for more information.

---

#### Key

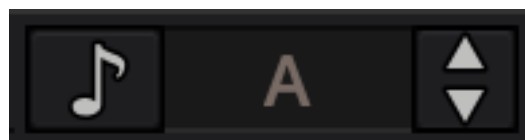

Figure6: The Key options.

The key displays the current musical key of the loaded track after pitch shifting. The key is displayed below the BPM (Tempo). This is the same as the key that is shown under the *Key* column heading in the *Mixxx library*. Clicking the key will expand it to reveal more options:

- **Pitch Control:** This changes the track pitch independent of the tempo. Left-clicking the - button decreases the pitch by one semitone. Right-clicking it decreases the pitch by 10 cents. Left-clicking the + button increases the pitch by one semitone. Right-clicking it increases the pitch by 10 cents.
- **Sync and Reset Key:** Left-clicking the *MATCH* button sets the key to a pitch that allows harmonic transition from the other track. It requires a detected key on both involved decks. Right-clicking it resets the key to the original track key.

**Cover Art** The cover art of the track loaded into the deck is displayed on the left side of the track. This is the same as the cover art that is shown under the *Cover Art* column heading in the *Mixxx library*. In Deere skin you can choose to enable or disable the cover art by clicking the gear icon in the upper right corner, then toggling the *Decks* ▶ *Cover Art* option. Clicking on the cover art will expand it into a full blown image. The cover art is also shown in the Vinyl Widget next to the *parallel waveforms*.

### 3.2.2 Waveform Displays

The waveform section of a deck allows you to visualize the audio changes that occur throughout the track, you can basically “see” your music.

By default the waveform displays are aligned parallel to each other in order to make *beatmatching* easier, as it is possible to beatmatch visually by aligning the beats that appear in each waveform.



Figure7: Parallel waveforms in the default Mixxx skin (LateNight, PaleMoon theme)

Depending on the skin, Mixxx displays either parallel waveforms (default) or separate waveforms. LateNight and Tango skins only have resizable parallel waveforms while Shade skin provides only separate waveforms. In Deere skin you can select your preferred appearance by clicking the gear icon in the upper right corner, then toggling the *Skin Settings* ▶ *Parallel Waveforms* option.

**Avvertimento:** If you have a slower computer and notice performance issues with Mixxx, try lowering the frame rate or changing the waveform type in *Preferences* ▶ *Waveforms*.

**Waveform summary** The big waveform summary shows the waveform envelope of the track near the current playback position and is updated in real time. The mouse can be used on the waveform to pause, scratch, spin-back or throw the tracks. Right-clicking on the waveforms allows you to drag with the mouse to make temporary pitch adjustments.

---

**Suggerimento:** You can select from different types of displays for the waveform, which differ primarily in the level of detail shown in the waveform, in *Preferences ▶ Waveforms ▶ Waveform type*.

---

**Waveform overview** The smaller, zoomed-out version of the waveform shows the various markers within the track as well as the waveform envelope of the entire track. This is useful because they allow DJs to see breakdowns far in advance. As visual aid, the part of the track that has already been played is darkened.

Clicking somewhere on the waveform allows you to jump to an arbitrary position in the track. Like with the Waveform summary, you can select from different types of displays for the overview in *Preferences ▶ Waveforms ▶ Overview type*.

**Vinyl Widget** The line on the vinyl widget rotates if the track moves. It is similar to the position marker found on scratch records. Use the mouse on the vinyl widget to pause, scratch, spin-back or throw tracks - just like a real record. When performing *Loop rolls* or right-clicking on the vinyl during playback, a “ghost” marker hints where the playback will continue. The Vinyl Widget is hidden by default and can be enabled in the *Deck Options Button Grid*.

If *vinyl control* is enabled, it can optionally display the time-coded vinyl signal quality. Activate the option in *Preferences ▶ Vinyl Control ▶ Show Signal Quality in Skin*.

**Waveform Zoom** Using the mouse-wheel everywhere in the waveform summary will zoom the waveform in or out. You can choose whether to synchronize the zoom level between the decks in *Preferences ▶ Waveforms*.

**Waveform Marker** While mixing, various additional markers can appear on the waveforms:

- **Position marker:** The static vertical line in the center of the waveform summary indicates the playback point of the deck. The waveform overview includes a vertical line to show the current position within the track.
- **Beat marker:** The regular white lines on the waveform summary indicate the locations of beats in the audio, also called the *beatgrid*.
- **Cue marker:** Indicates the position of the *cue point*.
- **Hotcue marker:** Indicate the position and number of a *hotcue* point if set.
- **Loop-in/Out marker:** Indicate the beginning and the end of a loop.
- **Loop overlay:** Is drawn between the Loop-in/Out markers and changes color depending on whether a loop is activated or not.
- **Track ending notification:** If the waveform overview flashes red, only 30 seconds are left before the track reaches the end.

### 3.2.3 Deck Options Button Grid



Figure8: The Options Button Grid of the deck

The six buttons at the bottom right below the waveform allow you to configure the deck. Starting from the top row (left to right) and the bottom row (left to right), the buttons are as follows:

**Slip Mode Toggle** When active, the playback continues muted in the background during a loop, reverse, scratch, etc. Once disabled, the audible playback will resume where the track would have been.



**Quantize Mode Toggle** If enabled, all cues, hotcues, loops, and beatloops will be automatically *quantized* so that they begin on a beat.

**Beat-grid Adjust Button** Clicking this button adjusts the track beat-grid so that the current position is marked as a beat. This is useful if Mixxx was able to accurately detect the track's *BPM* but failed to align the beat markers on the beats. For more information, go to the chapter *Riconoscimento Beat*.

**Eject Track Button** Clicking this button ejects the track from the deck. Alternatively you can use a keyboard shortcut, go to the chapter *Using a Keyboard* for more information.

**Repeat Mode Toggle** If enabled, the repeat mode will jump back to the beginning and continue playing when the track finishes.

**Keylock Toggle** *Key lock* locks the track's pitch so that adjustments to its tempo via the rate slider do not affect its pitch. This is useful if you would like to speed up or slow down a track and avoid the "chipmunk" effect that speeding up vocals has.

### 3.2.4 Playback/Cue Controls



Figure9: The playback and cueing controls of the deck

**Play/Pause Button** Clicking the Play/Pause button starts and pauses the playback.

**Vedi anche:**

The actual behavior of the Play/Pause button depends on the selected *Cue mode*.

**Cue Button** If the button is pressed while the track is playing, the play position jumps to the *Cue point* on the track and the track is paused. Once the track is paused at the Cue point, you can preview it by holding the Cue Button. If you have not moved the Cue point yet, the default point is at the track's beginning.

**Vedi anche:**

The actual behavior of the Cue button depends on the selected *Cue mode*.

**Reverse button** Press and hold this button to temporarily play the track backwards during regular playback. Right-click and hold for "Censor" mode. This reverses the track while the playback continues muted in the background. On release playback is resumed where the track would have been if it had not been reversed.

#### Setting Cue points

Every track has a Cue point, by default on its beginning. Unlike with *Hotcues*, you can't delete, but only move Cue points. The Cue point is moved according to the selected Cue mode, as explained below.

## Auto Cue

Mixxx automatically seeks to the saved Cue point on track load. If none exists, seeks to the beginning of the track.

Uncheck *Preferences* ▶ *Interface* ▶ *Auto Cue* ▶ *Jump to main cue point on track load* to always seek to the beginning of the track.

## Using Cue Modes

Mixxx supports various Cue modes that adapt to fit other devices in your setup or your personal preferences. The actual behavior of the Play, Pause, and Cue buttons depends on the selected Cue mode. To change the Cue mode, go to *Preferences* ▶ *Decks* ▶ *Cue mode*.

### Mixxx mode (default)

- **While paused at Cue point (Cue button lit):**
  - Hold down the Cue button to play the track from the *Cue point*, as long as the button is pressed. After releasing the Cue button, the track jumps back to the Cue point and pauses again.
  - Press Play/Pause before releasing the Cue button to continue playback normally.
- **While paused not at Cue point (Cue button flashing):**
  - Tap the Cue button to store the current position as new *Cue point*.
- **While playing:**
  - Tap the Cue button to jump to the *Cue point* and pause playback.

### Mixxx mode (no blinking)

- Same as the default Mixxx mode, but without blinking indicators.

### Pioneer mode

- Same as Mixxx mode, but the buttons are more flashy matching a Pioneer CDJ player.
  - The Play/Pause button flashes once per second when a track is paused.
  - The Cue button flashes twice a second when the next push will move the *Cue point*.

### Denon mode

- **While paused at Cue point (Cue button lit) - same as Mixxx mode:**
  - Hold down the Cue button to play the track from the *Cue point*, as long as the button is pressed. After releasing the Cue button, the track jumps back to the *Cue point* and pauses again.
  - Press Play/Pause before releasing the Cue button to continue playback normally.
- **While paused not at Cue point (Play button flashing):**
  - Tap the Cue button to move the track back to *Cue point*.
  - Tap the Play/Pause button to move the *Cue point* to the current position and start playback.
- **While playing - same as Mixxx mode:**
  - Tap the Cue button to jump to the *Cue point* and pause playback.

### Numark mode

- Same as Denon mode, but without a flashing Play/Pause button.
- This mode is useful if you want to implement a custom skin with 3-button decks, featuring a Cue button, a dedicated Pause button, and a Play/Stutter button.

### CUP (Cue + Play) mode

- Press the Cue button to jump to the *Cue point* and pause, continuing playback only when either the Cue button is released or Play/Pause is pressed.
- If the Cue button is pressed while paused, the *Cue point* is first moved to the current position.

---

**Suggerimento:** Use the *Hotcue Controls* to place more reference points on a track.

---

#### Vedi anche:

You can also use keyboard shortcuts for Cueing. Go to *Using a Keyboard* for more information.

## 3.2.5 Intro/Outro Markers



Figure10: The Intro/Outro End and Start Markers

You can use the Intro/Outro Markers with Auto DJ to mix in and out of points but unlike hotcues, they do not mark only one point. The intro and outro are sections and each section is defined by two points. See *Auto DJ - Automate your mix*.

**Intro Start/End Markers** The analyzer places the intro start point at the first sound of a track and you can decide where to place the intro end point. Left-clicking on the marker when it is set jumps to the marker. When it is not set, clicking sets the marker to the current play position. Right-clicking on the marker when it is set clears the marker.

**Outro Start/End Markers** The analyzer places the outro end point at the last sound of a track and you can decide where to place the outro start point. Left-clicking on the marker when it is set jumps to the marker. When it is not set, clicking sets the marker to the current play position. Right-clicking on the marker when it is set clears the marker.

---

**Nota:** If *quantization* is enabled, left-clicking on any of the markers snaps to the nearest beat.

---

## 3.2.6 Transport Controls



Figure11: The transport controls of the deck

**Beatjump/ Loop Move Size** You can type, use the arrow keys or scroll vertically in the input box to select the number of beats to jump or move, with the Beatjump Forward/ Backward buttons.

**Beatjump Backward button** Clicking this while the loop is inactive will make the track jump backward by the set number of beats (left click) or by one beat (right click). Clicking this while the loop is active will move the loop backward by the set number of beats (left click) or by one beat (right click).

**Beatjump Forward button** Clicking this while the loop is inactive will make the track jump forward by the set number of beats (left click) or by one beat (right click). Clicking this while the loop is active will move the loop forward by the set number of beats (left click) or by one beat (right click).

### 3.2.7 Vinyl Control Mode and Cueing controls



Figure12: The Vinyl Control Mode and Cueing controls of a deck

The control above the waveforms relate to the *vinyl control* feature in Mixxx and is **hidden** in the default *Mixxx user interface*. Click the gear icon in the upper right corner, then toggle *Skin Settings* ▶ *Vinyl Control Options*, or use the specific *Application shortcuts* to show or hide the section.

#### Vedi anche:

For more information on how to use Vinyl control in your setup, go to the chapter *Controllo Vinile*.

#### Vinyl button

This button enables *vinyl control*. When enabled in Mixxx, the track on the Mixxx deck is controlled by the external vinyl control.

#### Pass button

This button enables passthrough. When enabled, audio from an external vinyl can be played on the Mixxx deck.

#### Abs/Rel/Const button

- **Absolute mode:** The track position equals needle position and speed.
- **Relative mode:** The track speed equals needle speed regardless of needle position.
- **Constant mode:** The track speed equals last known-steady speed regardless of needle input.

#### Cue/Hot button

This button determines how *cue points* are treated in vinyl control relative mode:

- **Off:** Cue points are ignored.
- **Cue:** If the needle is dropped after the cue point, the track will seek to that cue point.
- **Hot:** The track will seek to the nearest previous *hotcue* point.

### 3.2.8 Sync and Rate Controls

The rate controls allow you to change the rate at which tracks are played. This is very useful for *beatmatching* two tracks together in a mix. You can control rate changes also from your computer's keyboard, see the chapter *Using a Keyboard* for more information.

#### SYNC button

- **Left-Click:** Changes the *rate* of the track so that the *BPM* and *phase* of the track matches the other deck.
- **Right-Click:** Only changes the *rate* of the track to match the other deck but does not adjust the *phase*.

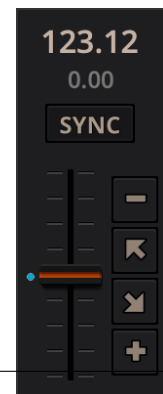

Figure 13: Rate controls

Decks and samplers now pick which sync target to sync to on the fly. Decks can't sync to samplers and samplers can only sync to decks. The sync target for samplers is:

- The first deck (in numerical order) that is playing a track with a detected beatgrid, and has a rate different than zero.
- The first deck (in numerical order) that has a track loaded with a detected beatgrid, no matter if it is playing or stopped.

So basically, if you sync a sampler and both deck 1 and deck 2 are playing a track with a beatgrid then deck 1 will win since numerically it is first. The sync targets for decks are chosen with the new master sync feature, see *Master Sync* for more information.

**Pitch/Rate slider** The slider allows you to change the speed of the song, by default up to 10% from the tracks original tempos. The speed will increase as you move the slider up, opposite to the behavior found on DJ turntables and *CDJ*. Right-clicking on the slider will reset the tempo to its original value.

**Pitch Rate Display** The percent that the track's rate is sped up or slowed down is noted here. Is the Pitch/Rate slider positioned at the center, the pitch rate display is at +0.0%, which indicates no change.

**Temporary Pitch/Rate buttons (Nudge)** Pushing the diagonal arrow buttons is like nudging the metal edge of a turntable, or the outer edge of a CD player. It will give the track a push or pull forwards or backwards. If the buttons are released the previous tempo is restored. The buttons can act as either a fixed *pitch bend* or a *ramping pitch bend*.

**Pitch/Rate buttons** Clicking the - button will set the pitch/rate lower while the + button will set the pitch/rate higher. This is like moving the pitch slider up or down by a fixed amount. Unlike using the temporary pitch/rate buttons, the change is permanent so these buttons don't need to be held down.

**Vedi anche:**

To customize the amount by which the buttons alter the pitch of the track, the slider range as well as the direction, go to *Preferences* ▶ *Interface* ▶ *Adjustment buttons* ▶ *Permanent / Temporary*.

---

**Suggerimento:** If the tempo of a track changes, you'll notice that the tone changes based on the pitch used (e.g. playing at faster pitch gives a chipmunk sound). You can enable the *Keylock* feature to maintain a constant tone.

---

### 3.2.9 Loop Controls



Figure14: The beatloop and looping controls of the deck

In this section of the Mixxx interface you can control (beat-)loops and set the loop points of a track. You can also shift loops using the *beatjump / loop move controls* shown at the right side of the looping controls.

**Beatloop size** The input box allows you to set the size of the loop in beats to set with the Beatloop button. Changing this resizes the loop if the loop already matches the size. If a loop is set, a loop overlay will be drawn on the *waveforms*.

**Beatloop** Left-clicking the Beatloop button starts a loop over the set number of beats. If quantize is enabled, it snaps to the nearest beat. This works for manually placed loops as well as automatic loops set by the beatlooping buttons.

Depending on the current status of the loop, the loop overlay on the waveforms changes color. Right-clicking the Beatloop button temporarily enables a rolling loop over the set number of beats. Playback will resume where the track would have been if it had not entered the loop.

**Double loop** Clicking on the arrow pointing up will double the current loop's length up to 64 bars. The length of the loop overlay in the waveform will increase accordingly.

**Halve loop** Clicking on the arrow pointing down will halve the current loop's length down to 1/32 bars. The length of the loop overlay in the waveform will decrease accordingly.

**Loop-In** This button allows you to manually set the start point of a loop. A loop-in marker is placed on the waveform indicating the position. If clicked when a loop was already set, it moves the start point of a loop to a new position.

**Loop-Out** This button allows you to manually set the end point of a loop. A loop-out marker is placed on the waveform indicating the position. If clicked when a loop was already set, it moves the end point of a loop to a new position.

**Reloop** Left-clicking this button toggles the current loop on or off. If the loop is ahead of the current position, looping will start when the loop is reached. This works only if the Loop-in and Loop-Out marker are set. Right-clicking this button enables the loop, jumps to Loop-in marker and stops playback.

---

**Suggerimento:** If you are playing inside a loop and want to move the end point beyond its current position in the track, click on the *Beatloop* button first and when the play position reaches the desired position, click on the Loop-Out button.

---

**Vedi anche:**

If the *Quantize* mode is enabled, the loops will automatically snap to the nearest beat. This is disabled by default, click on the *Quantize Mode Toggle* to enable it.

### 3.2.10 Hotcue Controls

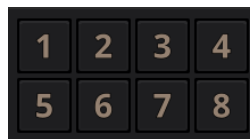

Figure 15: The hotcue controls of the deck

To jump in between different parts of a track, you can use these numbered buttons. You can also use keyboard shortcuts, go to *Using a Keyboard* for more information.

#### Setting Hotcues

Clicking on a numbered button will set a *hotcue* at the current play position on the track. A marker with the corresponding number will appear in the waveform and the button will light up to indicate that the hotcue is set.

## Playing Hotcues

- **While playing:** Tap a hotcue button to cause the track to instantly jump to the location of the hotcue and continue playing. If you are playing inside a loop and tap a hotcue whose position is outside of the loop, then the track still instantly jumps to the hotcue but the loop will be deactivated.
- **While stopped:** Tap a hotcue button to cause the track to instantly jump to the location of the hotcue and start playing as long as the button is pressed. Press the *Play* keyboard shortcut while the hotcue button is pressed to continue playback, then release the hotcue button.

## Highlighting Hotcues

It's possible to add labels or colors to your hotcues to make them easier to distinguish and make it possible to get their «meaning» at first glance.

Labels and colors can be assigned from the Hotcue context menu, which can be opened by right-clicking either the hotcue button or the hotcue marker in the waveform overview.

---

**Suggerimento:** Mixxx allows *customizing the color palette* and *bulk replacing hotcue colors*.

---

## Deleting Hotcues

To delete a hotcue, right-click on the hotcue button or the waveform marker in the overview waveform to open the context menu, then click the trash icon.

---

**Nota:** Mixxx supports up to 36 hotcues per deck. By default, only some of them are visible in the user interface. You can customize your *keyboard* or *controller* mappings to use all of them.

---

### Vedi anche:

Just as with the loops (see above), if the *quantize* mode is enabled, the hotcues will automatically snap to the nearest beat. This is disabled by default, click on the *Quantize Mode Toggle* to enable it.

## 3.3 Mixer

The mixer section of the *Mixxx user interface* allows you to control how the different decks and samplers are mixed together.

### 3.3.1 Channel Faders and Level Meters

**Level meters** The left meter shows the volume level for the left deck, while the right meter shows the volume level for the right deck. The double meter at the center shows the current volume of the main output's left and right channel separately. These should stay at the top of the green region, with the loudest parts of the music (transients) briefly going into the yellow region. They should never be in the red region. Refer to *Setting your levels properly (gain staging)* for more details.

**Line faders** The two large faders on either side of the level meters are the deck volume faders, also known as Channel- or Line-faders. Adjusting these controls the volume of each deck.



Figure16: The mixer section

---

**Suggerimento:** Some DJ's prefer to use the line faders over the crossfader for fading between tracks. Try it, you may like it.

---

### 3.3.2 Equalizers and Gain Knobs

**Gain Knob** The gain knob (orange) above the volume fader allows you to adjust the gain applied to the deck. Use this to compensate for the differences in recording levels between tracks. In general, you should adjust this knob so that the track's *level meter* stays around the top of the green region with the loudest parts of the track (the transients) briefly going into the yellow region. **Do NOT turn the Gain Knob up so much that the level meter is in the red region. At this point the track is clipping, which sounds bad and could damage equipment.**

---

**Nota:** By default, Mixxx automatically applies an additional ReplayGain so tracks have approximately equal loudness at unity gain. Your tracks must be *analyzed* to take advantage of this feature. When an unanalyzed track is loaded, Mixxx calculates its ReplayGain value, but will not apply a newly calculated ReplayGain value to a track after it has already started playing (to avoid a sudden change in the gain of a playing track).

---

#### Vedi anche:

For an explanation of why you should set your gains this way, see *Setting your levels properly (gain staging)*.

#### EQ Knobs

The low, mid, and high EQ knobs allow you to change the filters of the audio. This allows you to selectively reduce or boost certain frequency ranges of the audio.





Figure17: EQ Controls

**Avvertimento:** Be careful not to raise the EQs so much that the signal clips, indicated by a *level meter* being in the red region. See *Setting your levels properly (gain staging)* for a more detailed explanation.

**Kill Switches** The small boxes next to each EQ knob are called *kills*. Hold these buttons to fully remove that frequency range. Short click on the buttons for latching. When in Latch mode, click again to restore the frequency range. If the Kill switches do not work as expected, check the high/low shelf EQ settings in the preferences.

**Quick Effect Super knob** This knob lets you control the Meta knob of the deck's Quick Effect. "Filter" is the default. Right-click this knob to center it. This is equivalent to "no audible effect" for the built-in filter effects only (Filter, Moog Ladder 4 Filter). The button next to the knob toggles the effect. It provides the same latching capabilities like the EQ Kill switches.

**Vedi anche:**

You can customize the EQ settings in *Preferences* ▶ *Equalizer*.

### 3.3.3 PFL/Headphone Button



Figure18: The headphone buttons of both decks in the mixer

The headphone button is also known as the *pre-fader listen or PFL* button and allows you to use headphone cueing. That is, it allows you to hear the track you will play next in your headphones before your audience hears it. This helps you plan when to start the next track and manipulate it to make it blend better with the currently playing track (for example, by synchronizing the beats, setting a loop, or using EQs). Pressing the PFL button plays the track on the headphone output at full volume regardless of the position of the crossfader or the deck's line fader. To play a track in your headphones but not have the audience hear it, press the PFL button and move the crossfader all the way to the opposite side of the deck or turn the deck's volume fader all the way down.

---

**Nota:** Headphone cueing is only available if you have configured a Headphone Output in *Preferences* ▶ *Sound Hardware*.

---

**Nota:** If you use an external hardware mixer, plug your headphones into that rather than your sound card. Use the headphone buttons on the mixer rather than the buttons in Mixxx.

---

### 3.3.4 Crossfader



Figure19: The crossfader section of the mixer

The *crossfader* determines the actual volume of each deck when moving the slider from left to right. If both decks are playing and the crossfader is in its default center position, then you will hear both decks. Right-clicking on the crossfader will reset the slider to its default position.

To move the crossfader left or right, you can use the *keyboard shortcut* G and H. To apply small crossfade left and small crossfade right, the *shortcuts* are Shift + G and Shift + H respectively.

You can reverse the configuration of the crossfader, so that the right deck is on the left end of the crossfader and vice versa. This is also known as *Hamster Style*. To adjust the crossfader to your style of mixing, go to *Preferences* ▶ *Crossfader*.

The *crossfader* orientation determines to which side of the crossfader the deck is assigned. It can be set to the left or right side, or to the center where it is unaffected by the crossfader knob.

---

**Suggerimento:** Using the *AutoDJ* feature in Mixxx, you can automate the crossfade between the decks.

---

### 3.3.5 Headphone and Main Mix Controls



Figure20: The headphone and main mix knobs

**Headphone Mix knob** Allows you to control how much of the Main output you hear in the *Headphones* output. It works like a crossfader between the stereo Main and stereo *PFL* signal. If the knob is set to the left, you only hear the *PFL* signal, which is the usual position for prelistening tracks.

This can be used to practice DJing with only one stereo output and a set of either speakers or headphones.

Additionally, this can be used to mix in headphones when you cannot hear the speakers connected to the *main* output and there are no booth monitor speakers. Some DJs prefer to use this knob to mix in headphones all the time, but many find it to be a difficult way to play. If there is only one set of speakers and no booth monitors, you can avoid the need to mix in headphones by setting up the speakers behind you so both you and your audience can hear them.

---

**Nota:** Don't forget to activate the *PFL* button on the deck you want to listen to in your headphones.

---

**Head knob (Headphone gain)**

This knob controls the gain applied to the headphone output signal that Mixxx sends to your sound card. Generally, this knob should not be adjusted. To adjust the volume in your headphones, adjust your sound card's gain on the headphone output. Most external sound cards have a gain knob specifically for the headphone jack. If you use an onboard sound card for your headphones, adjust the gain control in your *OS* mixer program. If your sound card only has one gain knob that controls both the Main output and the headphone output, then adjust the *Head* knob in Mixxx to control the volume of your headphones without affecting your Main output.

**Nota:** Not all controls may be present in all skins anymore. However, these controls can be mapped to keyboards and MIDI controllers. See *Mixxx Controls* for detailed information.

**Headphone Split Cue button** If activated, two mono signals are sent to the headphone output instead of one stereo signal. The main signal plays in the right channel, while the cueing signal plays in the left channel. You can still adjust the *Head Mix* knob to control the mix of the Main and cue signals in the left channel.

**Balance Knob** This knob allows you to adjust the *balance* (left/right orientation) of the Main output.

**Main Knob** The Main Gain Knob controls the gain applied to the Main output signal that Mixxx sends to your sound card, Internet broadcasting servers, and recorded mixes. Generally, this knob should not be adjusted. To change the output volume, a gain control should be adjusted as close to the speakers as possible for the best signal-to-noise ratio throughout your signal chain. Ideally, the volume would only be adjusted by adjusting the gain on the power amplifier. On active speakers, including computer speakers, studio monitors, and PA systems that do not require a separate amplifier, this means adjusting the gain on the speakers (which may be labeled «Volume»).

As a DJ, you may not have access to the power amplifier. In that case, adjust the volume by adjusting the gain on the equipment closest to the power amplifier that you have access to. Typically, this is a DJ mixer. If you are not going through a mixer, adjust the gain of your sound card. If your sound card does not have any controls on it (for example, for sound cards built into computers), adjust the sound card settings with your *OS* mixer program. The Main Gain Knob in Mixxx should be a last resort for adjusting volume.

**Avvertimento:** In no case should any part of the signal chain be clipping, indicated by a level meter going into its red region or an LED labeled «clipping» turning on.

**Vedi anche:**

For an explanation of why you should set your gains this way, see *Setting your levels properly (gain staging)*.

### 3.4 Samplers



Figure21: Sample decks



Figure22: Sample decks expanded

Samplers are miniature decks. They allow you to play short samples and jingles but also additional tracks in your mix. They come with a small overview waveform and a limited number of controls. All controls work just like on the regular decks, see *Decks*.

The Sampler section can be **hidden** in the *Mixxx user interface*. Click the *SAMPLERS* button at the top of the user interface, or use the specific *Application shortcuts* to show or hide the section.

### 3.4.1 Waveform Display

**Waveform overview** The waveform shows the various markers within the track as well as the waveform envelope of the entire track. Clicking somewhere on the waveform allows you to jump to an arbitrary position in the track.

**Waveform Marker** While mixing, some additional markers can appear on the waveforms:

- **Position marker:** A vertical line indicates the playback point of the sample deck.
- **Hotcue marker:** Indicate the position and number of a *hotcue* point if set.

### 3.4.2 Track Information Display

**Track Artist/Title** The artist and title of the track that was loaded into a sampler deck is displayed here.

**BPM (Tempo)** The number at the top right is the effective *BPM* of the track. Tap the BPM to set the BPM to the speed you are tapping.

### 3.4.3 Sample Deck Options Button Grid

The buttons grid next to the waveform overview allow you to configure the sampler deck. Starting from the top row (left to right) and the bottom row (left to right), the buttons are as follows:

**Repeat Mode Toggle** If enabled, the repeat mode will jump back to the beginning and continue playing when the track finishes.

**Eject Track Button** Clicking this button ejects the track from the deck.

**Keylock Toggle** *Keylock* locks the track's pitch so that adjustments to its tempo via the rate slider do not affect its pitch.

**Crossfader Orientation Toggle** The *crossfader* orientation determines to which side of the crossfader the sampler is assigned. It can be set to the left or right side, or to the center where it is unaffected by the crossfader knob.

### 3.4.4 Sample Deck Controls

**Play/Pause button** Clicking the button always starts playback from the *cue point*. If playback is already enabled the play position will jump back to the *cue point*. Right-clicking on the button will stop playback and seek the play position to the beginning of the sample.

**Sync Button** Syncs the Sampler deck to a regular deck, as described in *Sync and Rate Controls*.

- **Left-Click:** Changes the *rate* of the track so that the *BPM* and *phase* of the track matches the sync target.
- **Right-Click:** Only changes the *rate* of the track to match the sync target but does not adjust the *phase*.

**Hotcue Controls** To jump in between different parts of a sample, you can use these numbered hotcue buttons.

**PFL/Headphone Button** If active, the *pre-fader listen or PFL* button allows you to listen to the track in your headphones.

**Gain Knob** Allows you to adjust the gain applied to the track.

**Level Meter** Shows the level of the signal and can be adjusted with the Gain knob.

**Pitch/Rate slider** The slider allows you to change the speed of the sample. Right-clicking on the slider will reset the tempo to its original value.

### 3.5 Effects



Figure23: Collapsed effect unit

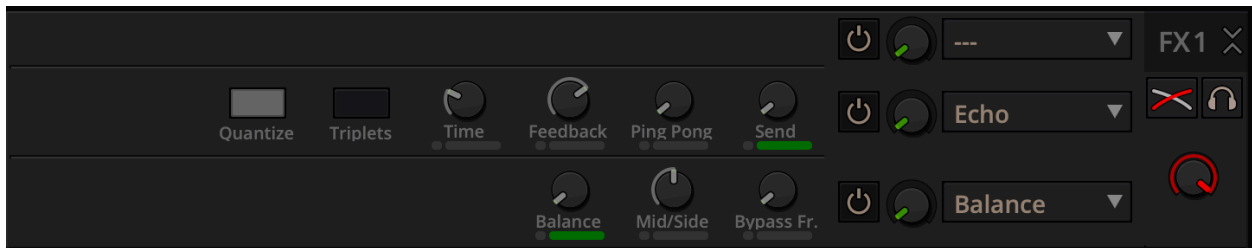

Figure24: Expanded effect unit

Mixxx comes with some built in sound effects that can be chained together in effect units. Effect units can be freely assigned to different decks as well as other inputs. The buttons for routing decks to effect units are in the *Decks*.

**Vedi anche:**

The *Effetti* chapter has a more detailed explanation of the effects system.

### 3.6 Microphones & Auxiliary Inputs



Figure25: The Microphone section

The microphone section is **hidden** in the default *Mixxx user interface*. Click the *MICS & AUX* button at the top of your user interface, or use the specific *Application shortcuts* to show or hide the section.

**Vedi anche:**

The *Using Microphones* chapter has detailed instructions for setting up microphones with various hardware.

### 3.6.1 Microphone Controls

**Talk Button** Hold this button and talk to mix the microphone input into the Mixxx Main output. Short click on the button for latching. This is handy for talking for an extended period, for example when *streaming* a radio show. When in Latch mode, click again to mute the microphone input.

**Mix Orientation Toggle** This control determines the microphone input's mix orientation. Either to the left side of crossfader, to the right side or to the center (default). Clicking cycles through all the options.

**Microphone Volume Meter** This displays the microphone volume input signal strength.

**Microphone Gain Knob** Use this knob to adjust the gain of the microphone output. Try to keep the volume at a reasonable level to avoid signal clipping.

## 3.7 Preview Deck

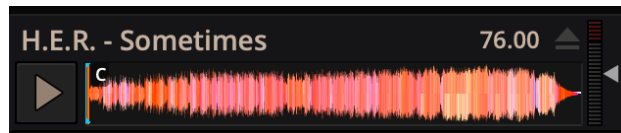

Figure26: The Preview Deck with a track loaded

The Preview Deck is a special deck that allows you to pre-listen to tracks in the headphones before using them in your mix. Pre-listening to a track does not change its *Played* state as well as the play counter and is not logged in the *History*. Press CTRL + 4 (Windows/Linux) or CMD + 4 (Mac) to display the Preview Deck.

The features in detail:

- **Track Artist/Title:** The artist and title of the track is displayed here. This is the same as that listed under the *Track* and *Title* column heading in the *Mixxx library*. This information is initially loaded from the track's *metadata*.
- **Eject Track button:** Clicking this button ejects the track from the deck.
- **Play/Pause button:** Clicking the button starts and pauses the playback. Right-clicking on the button will stop playback and seek the play position to the beginning of the tracks.
- **Waveform overview:** Shows the various markers (Cues, Hotcues) within the track as well as the waveform envelope of the entire track. Clicking somewhere on the waveform allows you to jump to an arbitrary position in the track.
- **Gain slider:** Move the slider to adjust the gain of the track.
- **Volume Meter:** Shows the current volume of the track. If it's too loud and distorted, a peak indicator flashes red.

**Vedi anche:**

For more information, go to the chapter *Previewing Tracks*.

## The Mixxx Library

## 4.1 Overview of the Library features

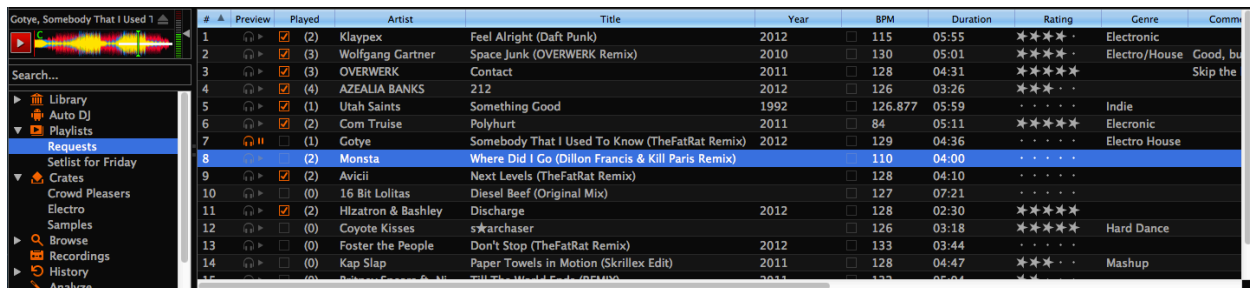

Figure1: The Mixxx Library

The library manages all of your music files. This is where you can find the tracks you want to play and load them into a *deck* or *sampler*; see *Loading Tracks*. Mixxx imports your music library automatically when it is run for the first time, see *Changing music directories* for more information.

The sidebar on the left contains different collections of music. The track list view on the right displays the tracks in those collections.

**Sidebar:**

- **Search:** Search for tracks in your Mixxx library.
- **Tracks:** View and edit your whole collection.
- **Auto DJ:** Automatically load and crossfade tracks for unattended mixing.
- **Playlists:** Arrange tracks in a set order.
- **Crates:** Organize tracks in (unordered) collections.
- **Computer:** Navigate, view, and load tracks from folders on your hard disk and connected devices.



- **Recordings:** Record your mix and view previous recordings.
- **History:** Browse lists of tracks played in past mixing sessions.
- **Analyze:** Generate Mixxx-specific data for tracks before a gig.
- **External Libraries:** Access your existing iTunes, Traktor, Rhythmbox, and Banshee libraries.

#### Track List:

- **Sort:** Display and sort track collections by different criteria.
- **Load:** Drag tracks you want to play to the waveform display.
- **Edit:** Rate tracks and edit track properties.

## 4.2 Tracks - View and edit your whole collection



A sortable list of all the tracks in your music library.

**Customizing the view** Move columns by clicking a column header and dragging it to another position. Right-click on a column header to show or hide individual columns. Adjust the column width to fit the contents of the rows by double-clicking on the separator between two column headers.

**Sorting Tracks** Tracks are automatically sorted by the active column. Click on the active column header to reverse the sort order. Click on another column header to change the active column.

- **Multi-Column sorting**

You can sort multiple columns by clicking *up to three* column headers you wish to sort your tracks by. This makes searching for tracks in a large list more efficient. Clicking twice on a column header will reverse the sort order.

Example:

1. Click on the *BPM* column header -> list is sorted by BPM
2. Click on the *Year* column header -> list is sorted by year. If year is equal, it is still sorted by the last criteria, e.g. BPM.
3. Click on the *Genre* column header -> list is sorted by genre. If genre is equal, it is still sorted by year. If genre and year is equal, then it is sorted by BPM.

- **Random sorting**

Click on the *Preview* column header to randomly sort tracks.

- **Sort keys by circle of fifths**

Click on the *Key* column header. The order starts with *C* at the top, then its relative minor (*a*), then adds 1 sharp (*G*), then *G*'s relative minor (*e*), and so adding sharps/removing flats around the circle of fifths. For *Lancelot* notation, it starts with *G#m* at the top, which is *1A* in that notation, and proceeds alphanumerically (minor keys appear before their relative major keys in this case).

**Rating tracks** Make sure the *Rating* column is not hidden. Rate tracks by hovering over the rating field and clicking the stars.

**Track Inline editing** Mixxx reads *metadata* from the tracks to fill the columns of the library. Double-click on a field, edit the data, and hit `Enter` when you are done. Go to the chapter *edit metadata* for detailed information.

**Loading tracks** To load a track into a *deck*, you can either drag it to the waveform display, use the context menu or use *keyboard shortcuts*. Go to the chapter *Loading Tracks* for detailed information.

**Importing tracks** Mixxx imports your music library automatically when it is run for the first time. Go to the chapter *Changing music directories* for detailed information.

**Previewing Tracks** To pre-listen to tracks in your headphones without loading them to a regular deck, click the  icon in the *Preview* column. Go to the chapter *Previewing Tracks* for detailed information.

**Cover/Album Art** Mixxx can display cover art it finds for a track in the library. It will search for available cover art in the following places in order and will use the first one it finds:

1. The first image saved in the track's ID3v2/Vorbis *tags*
2. An image file in the track folder (if there is only one image file there.)
3. `%track-file-base%.jpg` in the track directory for `%track-file-base%.mp3`
4. `%album%.jpg`
5. `cover.jpg`
6. `front.jpg`
7. `album.jpg`
8. `folder.jpg`

Mixxx supports the following image types: jpg, jpeg, png, gif, bmp

**Rescan Library** If you want to manually refresh your library without exiting (for example because you added or moved files) you can do this with *Library ▸ Rescan Library* in the menu at the top of the application window. You can prompt an automatic rescan when Mixxx is started under *Preferences ▸ Library ▸ Rescan on startup*.

Rescanning the library will add new files to the library and mark tracks as missing if the corresponding file has been deleted. It tries to detect and relocate missing tracks if files have been renamed or moved into another directory.

Automatically refreshing the metadata of tracks when files have been modified by an external application is not supported, yet. In this case you need to select the affected tracks and (re-)import their metadata from file tags.

## 4.2.1 Track list context menu

Right-clicking on selected tracks in the track list reveals the context menu:

- **Add to Auto DJ**

Adds the content of the selection to either the *bottom* or *top* of the *Auto DJ* playlist for automatic mixing. The *replace* option deletes the Auto DJ queue first, and then fills it with the selected tracks.

- **Load to**

Loads a selected file to one of the available *Decks*, *Samplers* or to the *Preview Deck*. Alternatively simply drag it to the *Waveform Displays*. The number of available decks and samplers might differ, depending on the selected skin. Note that you can't load multiple files at once.

- **Add to Playlist**

Add selected tracks to an existing playlist, or drag the selection to a playlist crate in the sidebar. Choose *Create new playlist* to put them into a new playlist.

- **Crates**

The checkbox shows in which existing crates the selection is in. Changing the crates selection does not collapse the menu, which allows much easier categorization of tracks without going through the menu from scratch. Choose *Create new Crate* to put them into a new crate.

- **Select Color**

Assign a color to all selected tracks to indicate mood, energy etc. Select the black button at the top left to remove the color.



- **Metadata**

- **Import from File Tags:** If the track's *metadata* changes, (e.g. if you used iTunes to edit it,) this option lets you save the new values for the selected tracks to the Mixxx library. See *edit metadata*.
- **Import from MusicBrainz:** Look up *metadata* online by searching the *MusicBrainz* database and apply the search results to your tracks. See *edit metadata*.
- **Export to File Tags:** Saves *metadata* to files. Mixxx may wait to modify files until they are not loaded to any decks or samplers. If you do not see changed metadata in other programs immediately, eject the track from all decks and samplers or shutdown Mixxx.
- **Cover Art**
  - \* **Choose New Cover:** Select an image from the file browser as the cover.
  - \* **Clear Cover:** Delete any cover information saved for this track.
  - \* **Reload from track/folder:** Reload the cover from the tracks' ID3v2 *tags* or a picture in the track folder if the tags do not supply any.

- **Clear**

- **BPM and Beatgrid:** Removes the *BPM* and *beatgrid* data from the selected tracks in the Mixxx library. After doing this, we recommend *analyzing* the tracks again.
- **Play Count:** Marks selected tracks as not played in the current session and sets their play counter to zero. The icon in the *Played* column changes.
- **Hotcues:** Clears all saved *hotcues* and *hotcue labels*.
- **ReplayGain:** Clears all saved *ReplayGain* values.
- **Waveform:** Clears the saved waveform data from the selected tracks. This is useful if a file is overwritten by another file of the same name, or was edited externally (e.g. in a waveform editor). To clear the waveform cache for all tracks in the library, select *Preferences* ▶ *Waveforms* ▶ *Clear cached Waveforms* .
- **All:** Clears all of the data above from the Mixxx library database at once.

- **Change BPM**

- Allows to change the *BPM* to 50%, 66%, 75%, 133,33%, 150%, or 200% of the BPM set by Mixxx when *analyzing* the tracks. If many of the detected BPM values are incorrect, you may try other settings in the *Analyzer Settings* and re-run the analysis.
- **Lock/Unlock BPM:** Locks/Unlocks the *BPM* of selected tracks so you can't edit them in the track properties. The  icon next to the track's BPM in the library row is a toggle. Clicking it will set the status to «locked», and the icon changes to .

- **Hide from Library**

Temporarily hides selected tracks from the track list. Hidden tracks are listed in the *Hidden Tracks* menu item which is explained below.

- **Open in File Browser**

Brings up the selected files in your file manager.

- **Properties**

---

Similar to inline editing explained above, the properties dialog allows you to view and edit metadata such as title, artist, album, and view the full file name and path. Note that you can not edit multiple files at once.

---

**Nota:** Most of the context menu items are available in file lists of other views like Auto DJ, Playlists, and Crates as well.

---

## 4.2.2 Missing Tracks

The Missing Tracks view is accessible by expanding the Library tree item in the sidebar. Any tracks that were previously loaded into your library but were later not found on your drive will appear here. Mixxx does not automatically delete records of missing tracks so that extra metadata Mixxx might have (such as hot cues and beat grids) will not be lost in case the file is replaced.

The features in detail:

- **Select All button:** Selects all tracks in the current view.
- **Purge button:** Purges the selected tracks from the Mixxx library, but does not remove them from your computer. This will delete all *metadata* Mixxx has for a track.

## 4.2.3 Hidden Tracks

The Hidden Tracks view is accessible by expanding the Library tree item in the sidebar. Any tracks that were previously loaded into your library but were later set to be hidden from the library will appear here. Use the *Hide from Library* context menu item in the *tracks* view to temporarily hide selected tracks.

The features in detail:

- **Select All button:** Selects all tracks in the current view.
- **Purge Button:** Purges the selected tracks from the Mixxx library, but does not remove them from your computer. This will delete all *metadata* Mixxx has for a track.
- **Unhide Button:** Removes the selected tracks from the *Hidden Tracks* view and makes them available in the regular track lists again. The tracks will re-appear in every playlist or crate they were in before being hidden.

**Vedi anche:**

To learn how to permanently remove tracks from the Mixxx library using the *Hidden Tracks* view, see [permanently remove tracks](#).

## 4.3 Loading Tracks

Tracks can be loaded into a deck in several ways:

- Right-click the *library track table*: Right-clicking on a track in the table will present the options *Load in Deck 1* and *Load in Deck 2*, among others. Making either selection will load a track into a deck.
- By *Using a Keyboard* to load the selected track in the library track table. Use keyboard  $\uparrow$  and  $\downarrow$  arrow button to select a track,  $\text{Shift} + \leftarrow$  to load into Deck 1 and  $\text{Shift} + \rightarrow$  to load into Deck 2.
- Drag-and-drop from library track table: Dragging-and-dropping a track from the track table onto a waveform display will load the track into that deck.

- Drag-and-drop from deck to deck: Once you've loaded a track to deck, sampler, or preview deck, click on the *track title*, *track artist* or cover art and drag it to another deck or sampler. Note that you can also drop tracks onto Playlists and Crates in the sidebar, as well as into track tables of active Playlists or Crates.
- Drag-and-drop from external file browser: Dragging-and-dropping a track from an external file browser directly onto a waveform display in Mixxx will load that track. This function also works with some other applications. For example, on macOS, dragging-and-dropping a track from iTunes onto one of Mixxx's waveform displays will load it into that deck.

## 4.4 Finding Tracks (Search)

The search function filters the currently displayed list (e.g. a playlist, a crate, or even the whole library) for tracks that match your search query.

- Activate the search input field by clicking in it or pressing CTRL + F (Windows/Linux) or CMD + F (Mac).
- Type your search term(s). Mixxx filters the tracks as you type and shows only those matching the search term(s). Search terms can include an artist's name, a song title, BPM, etc.
- To clear the search string hit ESC or click the clear button right next to the input field.
- Hit TAB to cycle between the search and the list of results in the library. Use the ↑ and ↓ keys to scroll in the list of results.

---

**Nota:** If the search input field has focus, the Mixxx keyboard shortcuts are disabled, see [Using a Keyboard](#).

---

### 4.4.1 Using search operators

Search operators allow you to form more complex search queries. They allow you to limit certain search terms to particular properties of your tracks.

Mixxx supports the following filters:

- **Text filtering:** album\_artist, album, artist, comment, composer, crate, genre, grouping, location, title

#### Examples

```
artist: "com traise"  
album: Danger  
genre: Trance  
title: foo  
composer: foo  
comment: foo  
genre: hip-hop -genre: gangsta
```

---

**Nota:** It doesn't matter if you have space between the colon and the argument or not. Quotes must be used for multi-word text arguments.

---

- **Numeric filtering:** bitrate, bpm, played, rating, track, year

#### Examples

```
bpm:140
bpm: >140
year: <2010
bpm: >=140
rating: <=4
bpm: 140-150
played: >10
```

---

**Nota:** You can put a space after the colon but currently there must be no space between the operator and the number.

---

- **Special filtering:** key, duration, added, dateadded, datetime\_added, date\_added
  - Supports fuzzy matching of key searches. The following example lists tracks with harmonically compatible keys to C# minor.

```
~key:c#m
```

You can combine operators but there's no way to do an "OR" search right now. The following example lists all tracks by "Danger" over 3 minutes long that are rated 4 or 5.

```
artist: Danger duration:>3m rating:>=4
```

- Negative search filters. Use the – prefix as negation operator. The following example would find "hip-hop" from any year but 1990.

```
genre:hip-hop -year:1990
```

- Search for empty fields. The following example lists all tracks without a genre. It works for all text fields, including crates.

```
genre:""
```

### Examples



```
duration:2m10
duration:<2:10
duration:>1m35s
duration:>62
```

---

**Nota:** You can put a space after the colon but currently there must be no space between the operator and the number.

---

## 4.5 Previewing Tracks

To pre-listen to a track, activate the *Preview* column in a library view. Clicking the  icon in the library's *Preview* column loads the selected track into a special *Preview Deck* that will only output sound in the *headphones* channel. Click the  icon to stop the playback.

Alternatively, select a track from the track list of the Mixxx library, drag the track to the waveform view of the *Preview Deck* and click the *Play* button next to the waveform.

To display the *Preview Deck*, press CTRL + 4 (Windows/Linux) or CMD + 4 (Mac).

---

**Suggerimento:** Click on the *Preview* column header to randomly sort tracks.

---

## 4.6 Edit metadata of audio files

Mixxx reads relevant *metadata* from the tracks and displays them in the library columns. You are free to edit most metadata, and Mixxx offers a number of different ways to do so. Note that some information can not be edited, such as bitrate, size, length, type, filename, and location.

---

**Nota:** Mixxx does not support editing the metadata of many tracks at a time (bulk editing).

---

**Avvertimento:** Mixxx won't touch your audio files by default. Changes to a track's metadata will be saved to the Mixxx library, but **not** to the track itself.

If you wish to write modified track metadata from the library into file tags, check the box in *Preferences* ▶ *Library* ▶ *Track Metadata Synchronisation*.

### 4.6.1 Manual Edit

**Track Inline editing:** To enable inline editing in the *library* go to *Preferences* ▶ *Library* ▶ *Miscellaneous* and check the box «Edit metadata after clicking selected track».

Select any track in the *library* and click on the field you want to edit. If the field is editable, it will become an editable text box. Enter a value and hit *Enter* when you are done.

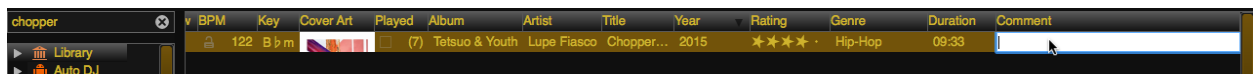

Figure2: Mixxx library - Inline editing

**Properties editor:** To open the editor right-click on a **single track** in the library or any track label in decks or samplers, then select *Properties* in the track menu. You can also double-click any track label in the decks or samplers to open the editor directly.

Add or change values in the editable fields, and save your changes as explained below.

- **OK:** Accept the changes and close the editor.
- **Apply:** Accept the changes and leave the editor open.

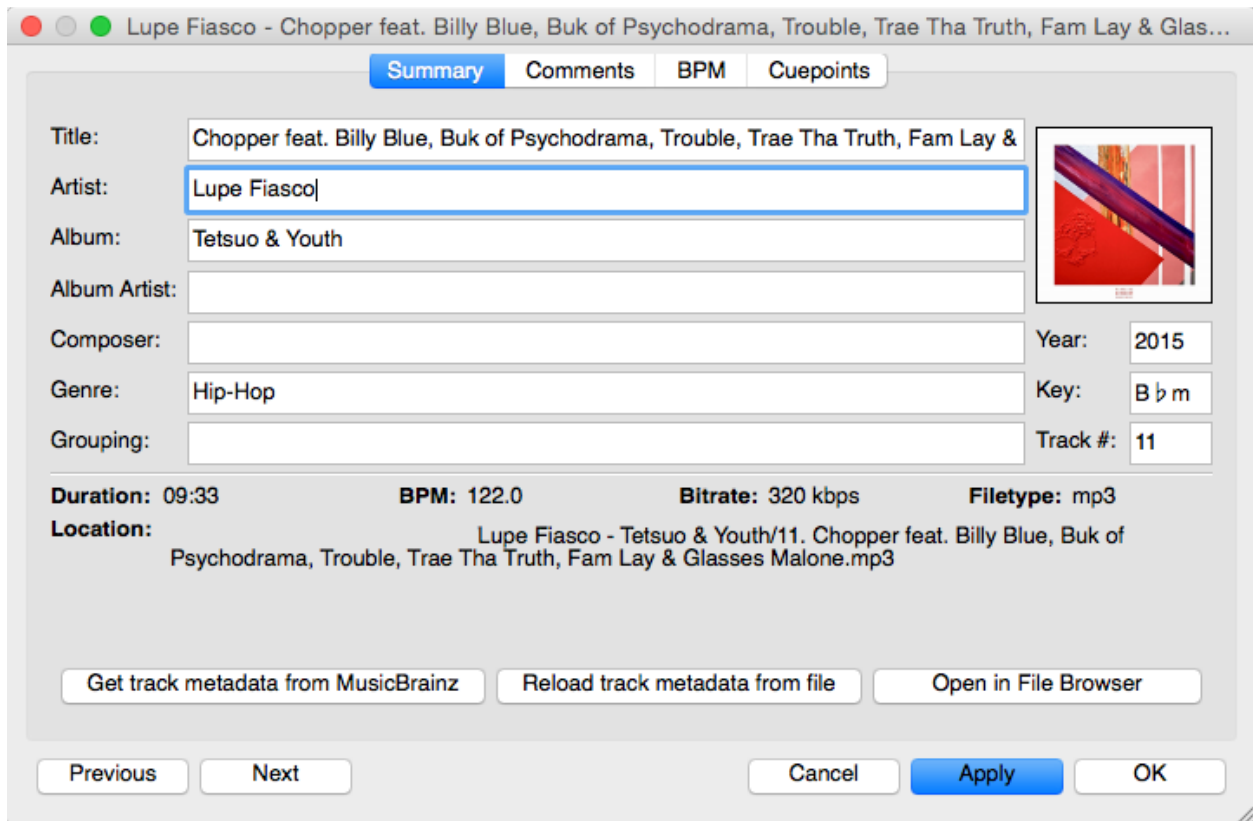

Figure3: Mixxx library - Properties editor



- **Cancel:** Discard the changes and close the editor.
- **Previous/Next:** Load the previous or next track in the current library view.
- **Import Metadata from File:** Prompts Mixxx to re-read the metadata of the selected track (such as when you have modified it externally with another application.)
- **Import Metadata from MusicBrainz:** Look up metadata on-line by searching the *MusicBrainz* database. See below.

## 4.6.2 Using the MusicBrainz online database

MusicBrainz is an *open-source* music encyclopedia that collects music *metadata* and makes it available to the public.

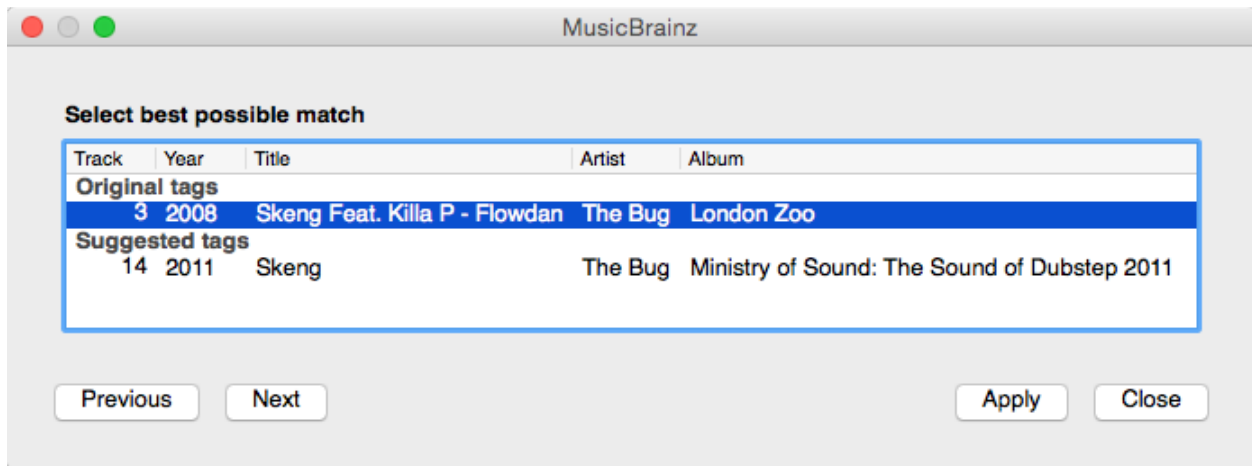

Figure4: Mixxx library - MusicBrainz Wizard

The MusicBrainz wizard in Mixxx allows searching the MusicBrainz database and applying the results to your tracks.

Click on a **single track** in the library and select *Get Metadata from MusicBrainz*. Mixxx fetches track data from the MusicBrainz database and displays the search results.

Select the best match from the search results by clicking on it in the list.

- **Apply:** Apply the selected MusicBrainz metadata to the track.
- **Close:** Close the wizard.
- **Previous/Next:** Load the previous or next track in the current library view and perform a MusicBrainz lookup on it as well.

### Fetching track metadata from MusicBrainz can fail:

- if Mixxx is unable to find the specified track in the MusicBrainz database,
- if Mixxx cannot reach the MusicBrainz servers (if they are down),
- or if you are not connected to the Internet.

**Suggerimento:** The MusicBrainz service has been designed for identifying full audio files. If a track is less than 2 minutes long, identifying the file will likely fail. Identifying a layered mix-track or mash-up may produce false positives in the result list.

### 4.6.3 Using third-party software

If you have edited file metadata in third-party software you need to re-import the modified metadata into Mixxx manually by selecting the affected tracks, open the context menu, and then choose *Metadata* ▶ *Import From File Tags*.

---

**Suggerimento:** Rescanning the library with *Library* ▶ *Rescan Library* in the menu on top of the application window will only detect newly added or removed tracks but no modifications of existing tracks. This is a known limitation.

---

#### Popular software to edit metadata of audio files include:

- [Mp3tag](#) (Windows)
- [Kid3](#) (Mac, Windows, Linux)
- [Picard](#) (Mac, Windows, Linux)

## 4.7 Auto DJ - Automate your mix



The Auto DJ queue is a special playlist that contains extra controls for automatic mixing. This is useful when taking a break from live mixing or for using Mixxx as media player.

The Auto DJ features in detail:

- **Shuffle button:** Randomizes the order of tracks in the Auto DJ playlist.
- **Add Random button:** Adds a random track from track sources (crates) to the Auto DJ queue. If no track sources are configured, the track is added from the library instead.
- **Skip track button:** Skips the next track in the Auto DJ playlist.
- **Fade now button:** Triggers the transition to the next track.
- **Transition time spin-box:** Determines the duration of the transition. A negative value will add a pause between tracks.
- **Selection Info label:** Displays the duration and number of selected tracks. Press `Ctrl + A` to get the total duration of the AutoDJ queue.
- **Enable Auto DJ button:** Toggles the Auto DJ mode on or off.

The *Skip track*, *Add Random* and *Fade now* buttons are only accessible if the Auto DJ mode is enabled. The Search field in the upper left corner is disabled in Auto DJ. By default, Auto DJ removes tracks after playing them but if you want it to play the same tracks over and over again, you can activate the *Auto DJ Requeue* option in *Preferences* ▶ *Auto DJ* ▶ *Re-queue tracks after playback*.

#### Auto DJ Crates

It is possible to add random tracks to the bottom of the Auto DJ playlist. The tracks are chosen from a set of crates that you have set as a source for Auto DJ, or from the standard library. Mixxx will normally try to select tracks that haven't yet been played. You can set a minimum number of tracks that are always available for selection no matter when they were last played in *Preferences* ▶ *Auto DJ* ▶ *Minimum available tracks in Track Source*.

#### Vedi anche:

For more information, go to the chapter [Auto DJ](#).

## 4.8 Playlists - Arranging tracks in a set order



Playlists are ordered lists of tracks that allow you to plan your DJ sets. Some DJs construct playlists before they perform live; others prefer to build them on-the-fly.

Playlists are not directly loadable into decks as Mixxx is primarily intended for live, attended performance use. However, you can right-click a playlist to queue it to *Auto DJ*, so in a sense you can «play» it.

- **Create a playlist:** Right-click on the *Playlists* sidebar item and select *Create New Playlist*. Name the playlist and click *OK*. The total number of tracks and total duration are displayed next to the name.
- **Import playlists:** Right-click on the *Playlists* sidebar item and select *Import Playlist*. Select one or more playlists and click *OK*. Mixxx creates an import of these existing external playlists as new Mixxx playlists.
- **Add Tracks:** Add tracks to a previously created playlist by dragging-and-dropping a selection of tracks from the library or playlists onto the name of a playlist in the sidebar. Alternatively, use the right-click context menu in the library's *track list*.

---

**Suggerimento:** If you have a track selected in the library, all of the visible playlist and crates that it is in are shown in bold.

---

Right-click on an existing playlist name to access the different features in the context menu:

- **Add to Auto DJ:** Adds the content of the playlist to the *Auto DJ* queue for automatic mixing.
- **Rename:** To rename a playlist, just enter a new playlist name and click *OK*.
- **Duplicate:** Sometimes you want to build a playlist based on an existing one. Select the playlist you would like to duplicate, choose *Duplicate Playlist*, name the new playlist and click *OK*.
- **Remove:** Removes an unlocked playlist. Tracks that were in the playlist remain in the library for later use.
- **Lock:**  This icon indicates a locked playlist. If a playlist is locked, you cannot add tracks, rename or delete the playlist. Choose *Unlock* from the context menu to unlock the playlist.
- **Analyze entire playlist:** Forces the analysis of the tracks in the playlist in the *Analyze* view.
- **Import playlist:** Import tracks from external playlists in various file formats to the selected playlist. For more information, go to *Using libraries from other software*.
- **Export playlist:** Export a playlist to various file formats such as *m3u*, *m3u8*, *pls*, *txt*, or *csv*. This allows you to use the data in other applications.
- **Export Track files:** This copies all of the tracks in a playlist into a folder such as an external USB stick. Only files are copied, not Mixxx-specific metadata like waveforms or cover art that is not embedded in the file.

## 4.9 Crates - Organizing tracks into collections



Crates are unordered collections of tracks, just like DJ cases holding your favorite records.

- **Create a crate:** Right-click on the *Crates* sidebar item and select *Create New Crate*. Name the crate and click *OK*. The total number of tracks and total duration are displayed next to the name.
- **Import crates:** Right-click on the *Crates* sidebar item and select *Import Crate*. Select one or more playlists and click *OK*. Mixxx creates an import of these existing external playlists as new Mixxx crates.
- **Add Tracks:** Add tracks to a previously created crate by dragging-and-dropping a selection of tracks from the library or playlists onto the name of a crate in the sidebar. Alternatively use the context menu in the library's *track list*.

Right-click on an existing crate's name to access the different features in the context menu:

- **Rename:** To rename a crate, enter the new crate name and click *OK*.
- **Duplicate:** Just like playlists you can duplicate an existing crate. Select the crate you would like to duplicate, choose *Duplicate Crate*, name the new crate and click *OK*.
- **Remove:** Removes an unlocked crate. Tracks in the crate are still available in the library for later use.
- **Lock:**  This icon indicates a locked crate. If a crate is locked, you cannot add tracks, rename or delete the crate. Choose *Unlock* from the context menu to unlock the crate.
- **Auto DJ Track Source:** Use this crate as a source for random tracks in Auto DJ, see *Auto DJ crates*.
- **Analyze entire crate:** Forces the analysis of the crate in the *Analyze* view.
- **Import crate:** Import tracks from external playlists in various file formats to the selected crate.
- **Export crate:** Export a crate to various file formats, such as *m3u*, *m3u8*, *pls*, *txt*, or *csv*. This allows you to use the data in other applications.
- **Export Track files:** This copies all of the tracks in a crate into a folder such as an external USB stick. Only files are copied, not Mixxx-specific metadata like waveforms or cover art that is not embedded in the file.

### 4.9.1 Crates vs. Playlists

Crates are unordered collections of tracks. Unlike playlists, they cannot contain duplicate entries and do not support arranging tracks within them.

Often DJs group tracks by genre, keep lists of favorite tracks, and/or prepare lists of tracks they want to play at a particular party. In these cases they rarely care about the order since they will choose it at the party based on the dance floor and mood. They certainly don't want duplicates in these lists. Crates serve these purposes. You can think of them like labels in GMail or Web 2.0 tags for your music.

If however you want to plan out a specific set and practice the transitions, you will want an ordered list of tracks. Playlists serve this purpose.

## 4.10 Computer - Loading tracks from anywhere on your computer

 This mode works like a file manager and allows you to load tracks from anywhere on your computer and connected devices, that are not necessarily already in your Mixxx library.

Click the *Computer* sidebar item to navigate the computer and find your music. Depending on your *operating system*, your music will usually be found in the “My Music” or “Music” folder. Drag the files you want to import to the  *Tracks* icon or directly to the *Waveform Displays*.

---

**Nota:** Currently you can only drag files (not folders) to the Mixxx library.

---

Right-click on a folder and choose *Add to Library* to add the folder as an additional music directory. Mixxx will watch this directory and its subdirectories for new tracks.

### Vedi anche:

For more information, go to *Changing music directories*.

### 4.10.1 Quick Links - Bookmark your favorite folders

Using the *Quick Links* sub-menu you can bookmark folders for direct access. Click the *Browse* sidebar item and navigate to the folder you would like to bookmark. Right-click and choose *Add to Quick Links*. The folder is now pinned below the *Quick Links*. To un-pin that folder, right-click and choose *Remove from Quick Links*.

## 4.11 Recordings

 In this section of the library you can start and stop recording your session as well as view previous recordings and the dates they were made.

### Vedi anche:

For more information, go to *Registrazione il tuo mix*.

## 4.12 History - Keep track of your sessions

 The history section automatically keeps a list of tracks you play in your DJ sets. This is handy for remembering what worked in your DJ sets, posting set-lists, or reporting your plays to licensing organizations. Every time you start Mixxx, a new history section is created. If you don't play any tracks during the session, it will be discarded.

 This icon indicates the current session.

Click on the *History* icon in the sidebar to switch to the *History* view, then right-click on a session's name/date to access the different features:

- **Add to Auto DJ:** Adds the content of the session to the *Auto DJ* queue for automatic mixing.
- **Rename:** Rename a session. The default is the calendar date (YYYY-MM-DD).

- **Remove:** Remove a previous (unlocked) session. (You cannot remove the current session.)
- **Lock:** Protect a previous session against accidental merge or deletion. An  icon indicates a locked session.
- **Create new history playlist:** Split off the current history session and add a new session without having to restart Mixxx. The current history must contain at least one track for this option to be available.
- **Join with previous:** Append the selected history session to the end of the previous one.
- **Export playlist:** Export a session in various file formats. This allows you to use the data in other applications.

## 4.13 Analyze - Prepare your tracks

This section allows you to analyze your tracks in advance of loading them into a deck. Analyzing tracks requires considerable CPU power and may cause skips in the audio while performing, so it helps to have your tracks analyzed before you play. See *Analyze your library* for details.

## 4.14 Using libraries from other software

Supported libraries:

-  iTunes (Windows, macOS)
-  Traktor (Windows, macOS)
-  Rhythmbox (GNU/Linux)
-  Banshee (Windows, macOS, GNU/Linux)
-  Serato (Windows, macOS)
-  Rekordbox (Windows, macOS)

The external library views allow you to use music libraries you have created in these third-party applications. You can access music as well as playlists. If available, Mixxx automatically loads the external libraries from their default locations on your hard drive.

---

**Nota:** Playing a track from an external library will add it to your Mixxx library.

---

### Vedi anche:

External libraries can be disabled under *Preferences* ▶ *Library*.

### 4.14.1 Using the iTunes/Traktor/Rhythmbox/Banshee/Rekordbox library

Right-click on the iTunes icon in the Library tree and select *Choose Library* to load the iTunes Music Library.xml from a different location. Select *Use Default Library* to reset.

- Right-click on a iTunes/Traktor/Rhythmbox/Banshee playlist and choose *Import Playlist* to import it into a new Mixxx playlist.
- If you have an iTunes configuration file (\*.xml) from a Windows or Mac partition mounted in Linux, you can load it and use your iTunes tracks and playlists as well.

### 4.14.2 Using the Rekordbox library

To read Rekordbox databases for CDJ/XDJ players on USB or SD devices, the database has to be exported to a USB or SD device with a FAT or HFS file system using the Rekordbox Export mode. Databases that have been moved to an external device via *Preferences > Advanced > Database management* in Rekordbox are not supported.

1. Plug your USB or SD drive in while Mixxx is running.
2. Click on the *Rekordbox* item in the library sidebar to scan for Rekordbox prepared USB drives. If no Rekordbox devices show up, you can click on *Check for attached Rekordbox devices (refresh)*.
3. Click on the desired removable device. All your folders and playlists will be revealed for you to play from.

### How Rekordbox hotcues, memory cues, and loops are imported

The following data is read:

- Folders
- Playlists
- Beatgrids
- Hot cues
- Memory cues
- Loops

Mixxx currently has one main cue point, one loop, and thirty eight hotcues. As such:

- All Rekordbox hotcues are mapped to Mixxx hotcues as expected, the first chronological Rekordbox memory cue is mapped to the Mixxx main cue.
- The first chronological Rekordbox loop is also mapped to the Mixxx loop.
- All loops (including the first loop), and all subsequent Rekordbox memory cues are appended as Mixxx hotcues following the previously imported Rekordbox hotcues.
- The hotcue and memory cue colors you assigned in Rekordbox are also imported, assisting in distinguishing between them.

Although additional imported Rekordbox loops only appear in Mixxx 2.3 as hotcues, their loop information is stored in the Mixxx library and will become usable in Mixxx 2.4.

### 4.14.3 Using the Serato library

Mixxx supports reading your Serato library and crates both from your local hard drive as well as portable USB drives. Smart crates are currently not supported.

Serato stores information such as hot cues, track color and beatgrid in the file tags. Regardless of whether a track is loaded into deck from the library or directly from the file browser, Mixxx will import that information automatically if present.

Saved loops are imported as well, but since Mixxx is lacking support for multiple saved loops, only the first loop is usable in Mixxx. All other saved loops can be used like regular hotcues for now.

Waveforms, Gain values and «Flips» are not imported from Serato.

---

**Nota:** Due to differences in the metadata format, importing Serato information from Ogg Vorbis files is currently not supported.

---

To import Serato libraries from external USB drives:

1. Copy music library from Serato into external USB drive
2. Plug in USB drive while Mixxx is running
3. Click on *Serato* in the library. All USB drives containing a Serato library will be detected automatically.
4. For each removable device, the library and all crates from Serato will be accessible.

If you have already added a track containing Serato Metadata to your Mixxx library in a Mixxx version that didn't support reading that data, you can reimport it from the file's tags via the track context menu.

**Avvertimento:** This action will clear your existing cuepoints in Mixxx if the file contains Serato Metadata

To reimport metadata from files:

- Right click on the track to show the context menu
- Select *Metadata* ▶ *Import From File Tags*.

---

**Suggerimento:** Decoders may slightly detect different track start and end times for files from different sources, this could possibly be because of the presence of countless encoders and decoders for MP3 and M4A/AAC. This problem may cause your cues to be shifted up by a few milliseconds. Mixxx might not always be able to mitigate this problem, but it's possible to shift all cues for a track at once as a workaround.

---

### 4.15 Removing tracks from the library

Removing tracks from the Mixxx library will **not** physically delete them from your drive. However it does delete extra metadata Mixxx might have (such as hotcues and the beatgrids), and removes links to playlists or crates.

1. Click the *Library* item in the sidebar.
2. Find and select the tracks you want to remove, perform a right-click on them and select *Hide from Library* from the context menu.
3. Expand the *Library* item in the sidebar and click on the *Hidden tracks* sub-item. All tracks that were set to be hidden from the library will appear here.



4. Select the tracks you want to remove, or use the *Select All* button.
5. To confirm you want to permanently remove these tracks from the library, click *Purge*.

---

**Suggerimento:** If you want to hide or purge only tracks from a specific folder you may use the `location: search operator`, or *sort the table* by «Location».

---



---

**Suggerimento:** If you later decide to add some of the deleted tracks back, import them to the Mixxx library again, see *Changing music directories*.

---

## 4.16 Compatible file formats

Mixxx supports a variety of audio file formats:

| Lossless                | Lossy                      |
|-------------------------|----------------------------|
| <i>FLAC</i> (flac)      | <i>MP3</i> (mp3)           |
| <i>Wave</i> (wav)       | <i>Ogg Vorbis</i> (ogg)    |
| <i>Aiff</i> (aiff, aif) | <i>AAC</i> (aac, m4a, mp4) |
|                         | <i>Opus</i> (opus)         |

Lossless formats preserve every detail of the original recording and are recommended for the best sound quality. The *FLAC* format compresses the files to take less space on your computer without sacrificing audio quality. *WAV* and *AIFF* files are uncompressed and take up much more space.

Lossy formats take up less storage space on your computer than lossless formats at the expense of reducing sound quality. Assuming an average track length of about 4 minutes, a 1 TB hard drive or solid state drive can store about 42000 *FLAC* files or about 115000 *MP3* files at 320 kbps.

There is no benefit to converting lossy file to lossless formats. The detail lost when making the lossy file cannot be recovered.

*AAC* (*M4A*) is supported on Windows Vista and macOS 10.8 onwards. The [Platform Update Supplement](#) is required for Windows Vista.

On Linux, *AAC* playback is disabled by default due to licensing restrictions. To enable the playback of *AAC* files, [build Mixxx from source with m4a/AAC files support](#).

**Avvertimento:** *DRM* protected files, such as *m4p* files purchased in the iTunes Store in 2009 or earlier, are not supported.

**Avvertimento:** *ALAC* files use the same container *MP4* container format and file extensions (*m4a*, *mp4*) as *AAC* files, but Mixxx cannot play *ALAC* files. It is recommended to convert *ALAC* files to *FLAC* for use in Mixxx. This will not reduce the sound quality of the files.

## 4.17 Music from audio CDs

Mixxx can not play music directly from audio CDs. Use a CD ripping program to copy the audio from the CD to files on your computer. It is recommended to save the ripped files in the *FLAC* format. Many different programs are available to rip CDs, but not every program is capable of saving them to `FLAC`.

# CHAPTER 5

---

## DJ Hardware

---

Although Mixxx can be used with just a laptop or desktop computer, fully taking advantage of Mixxx's features requires specialized DJ hardware. Depending on your budget and application area, your setup and requirements may vary. This chapter provides general background information about various types of DJ hardware.

To make DJing with Mixxx a fun experience, at least the following pieces are needed:

- speakers to play the music to the audience,
- an *audio interface* with 4 mono/2 stereo output channels (or 2 mono output channels + a *DJ splitter cable*),
- *headphones* for prelistening tracks while another track is playing on the speakers, and
- audio cables and adapters to connect the equipment to your computer.

Additionally, you might consider getting the following equipment:

- a *controller*,
- *turntables*, an audio interface with phono inputs and *timecode vinyl*,
- a laptop/controller stand,
- a surge protector to protect the equipment from voltage spikes,
- cases for laptop, controller and headphones, and
- custom fader and knob caps to customize your gear.

### **Vedi anche:**

Instructions how to use DJ Controllers that work out-of-the-box with Mixxx can be found in the *Hardware Manuals* section of this manual. The [Mixxx DJ Hardware Guide](#) on the Mixxx Wiki also lists additional devices, including information about their prices, features, and compatibility with Mixxx.

## 5.1 Controllers

DJ controllers are devices with knobs, faders, buttons, and jog wheels to control DJ software such as Mixxx. Controllers allow quick access to different controls while providing tactile and visual feedback indicating the state of each control, such as the position of a knob or whether a switch is on or off. This allows you to focus on manipulating the music without needing to look at your computer screen all the time. Controllers also allow using two hands to manipulate two different controls at the same time, which is required for many mixing techniques.

DJ controllers typically do not do any actual audio processing. Instead, they send signals (typically *MIDI* or *HID* over a USB cable) to the computer to instruct DJ software how to manipulate the audio. Many DJ controllers include an *audio interface* with 2 separate stereo outputs built into the device. This allows the DJ to transport and setup only one piece of hardware in addition to a laptop. Some devices can be used as both a controller and *hardware mixer*.

Mixxx can work with any *MIDI* or *HID controller* as long as there is a mapping file to tell Mixxx how to understand the controller's signals. Mixxx comes bundled with a number of MIDI and HID mappings, which are listed in the *Hardware Manuals* section. For controllers that Mixxx does not yet support, you can [search the forum](#) to see if anyone has started a mapping. You can also start one yourself using the information in the [Controller Mapping Documentation](#) on the wiki.

### Vedi anche:

*Using MIDI/HID Controllers* describes how to configure Mixxx to use controllers.

## 5.2 Audio Interfaces

An audio interface (also known as a «sound card», although few of them are shaped like cards anymore) is a device that allows a computer to send output to and receive input from audio equipment. Whether using *internal* or *external mixing*, it is recommended to use a single audio interface with at least 4 independent output channels (2 separate stereo pairs).

The headphone jack on most laptops is not a second audio output. Rather, plugging headphones into the jack simply redirects the laptop's single stereo output from its speakers to your headphones. A *splitter cable* can be used to separate the stereo output of a headphone jack into two separate mono outputs for headphone cueing, but it is recommended to use a sound card with at least four mono outputs (for two stereo pairs). Such sound cards tend to be higher quality than those built into laptops and allow your mix to be enjoyed in stereo by your audience.

Unlike some proprietary DJ systems, Mixxx can use any audio interface and any *MIDI* or *HID* controller that your *OS* has drivers to use. If your controller has an integrated audio interface, you may choose to use a different audio interface for higher quality audio. Mixxx can also use multiple audio interfaces simultaneously.

### 5.2.1 Audio Interface Considerations

This section provides background information to help you choose an audio interface to use with Mixxx.

#### Bit Depth and Sample Rate

Most music is published with a bit depth of 16 bits at a sample rate of 44.1 kHz because this is all that is needed to store all the detail of music in digital form.

Bit depth determines the possible dynamic range of the signal. 16 bits is more than enough for playing back music. While 24 bits is helpful for recording, [it is useless for playback](#).

Half the sample rate determines the maximum frequency that can be represented by the signal. Humans generally can't hear frequencies above 20 kHz, so a sampling rate of 44.1 kHz, representing a maximum frequency of 22.05 kHz, is fine for playback. Higher sample rates like 88.2 kHz and 96 kHz can be helpful to reduce aliasing distortion when recording, but have no benefit for playback and make your computer work harder.

For a more thorough and technical explanation of why 16 bits at 44.1 kHz is all that is needed for playback, read [24/192 Music Downloads Are Very Silly Indeed](#).

## Specifications

When considering specifications, higher dynamic range, higher signal-to-noise ratio (SNR), higher maximum output level, lower THD+N (Total Harmonic Distortion + Noise; look for a more negative dB value or smaller percentage), and lower crosstalk (more negative dB value) are better. Cheap audio interfaces tend to not have these specifications published.

## Connector and Cable Types

If you are unfamiliar with professional audio equipment, read Digital DJ Tips' [Essential Guide to Audio Cables for DJs](#) to understand the different kinds of connectors on audio interfaces. It is better to use an audio interface with balanced outputs, especially if you will run long cables directly into an amplifier or active speakers without going through a *hardware mixer*. Balanced signals reject interference and are less susceptible to ground loop hum issues (which can be a problem when plugging unbalanced gear into separate power sources).

However, most venues have DJs plug into *hardware DJ mixers*, which typically only have RCA inputs (RCA cables cannot be balanced). Most home/computer speakers and amplifiers have RCA and/or 1/8» TRS stereo inputs. Most live sound mixers have balanced 1/4» TRS mono inputs. If you need to interconnect balanced and unbalanced gear, refer to this [guide from Presonus \(deleted, via archive.org\)](#) and this [guide from Rane \(deleted, via archive.org\)](#).

## Number of Channels

Audio interfaces sometimes have multiple connectors for a single channel, resulting in more connectors than channels. So, not every connector can send or receive an independent signal. For example, some audio interfaces made for DJing have 4 output channels with 4 mono output connectors and 1 stereo headphone connector. This does not mean that the audio interface can send out 6 different signals at the same time; rather, the signal on 2 of the mono outputs and the stereo headphone output would be the same. Also, many controllers have separate master and booth outputs with independent volume controls, but they both play the same signal.

## Vinyl Control and Phono Preamplifiers

Turntables output low voltage (phono level) signals that need to be amplified to line level before most audio equipment can work with them. So, if you want to use *Controllò Vinile*, sometimes referred to as a Digital Vinyl System (DVS), it is best to have phono preamplifiers (one for each deck) somewhere between your turntable and sound card to boost the turntable's phono level signal to line level. Mixxx can amplify phono level signals in software, but it is better to do it in hardware. The phono preamp can be in the turntable, in the audio interface, or a stand alone device. Most audio interfaces do not have phono preamps; these are generally found on audio interfaces specifically made for controlling DJ software with timecode vinyl. *Mixers* with audio interfaces have phono preamps on their deck inputs, but not necessarily on every deck input. Many higher-end all-in-one controllers also include audio interfaces with phono preamps.

## Driver Support

Unlike some proprietary DJ programs, Mixxx works with any audio interface that is compatible with your operating system — including for timecode vinyl (DVS) use.

USB Audio Class compliant audio interfaces should work out of the box on all operating systems supported by Mixxx. This is the case for the integrated audio interfaces in most DJ controllers. Sound cards that aren't USB Audio Class compliant need a driver for each OS.

---

**Nota:** On Windows, you should install the manufacturer's drivers even for USB class compliant audio interfaces to be able to use the recommended ASIO sound API.

---

---

**Suggerimento:** If you are considering buying a controller or audio interface, the easiest way to tell if it is USB class compliant before you buy it is to search for macOS drivers for the device on the manufacturer's website. If it is advertised as compatible with macOS or iOS but there are no drivers to download for macOS, the device is USB class compliant.

---

## 5.3 Mixers

Mixers are devices that combine audio signals. DJ mixers are different from live and studio mixers because they have multiple stereo channels with phono preamplifiers for connecting *Turntables*. It is conventional to use a DJ mixer with *Controllo Vinile*, but vinyl control can be used without a hardware mixer.

Using Mixxx with a DJ mixer requires an audio interface with at least 4 mono outputs (2 stereo pairs) to send Mixxx's decks to the mixer's stereo channels. Some DJ mixers have a USB *audio interface* built into them. This lets Mixxx send unmixed audio files directly to the mixer without needing a separate stand-alone audio interface.

Often DJs who use DJ software with internal mixing send their master output to a hardware mixer. This can be helpful to send the mixed signal to both a main speaker output for the audience and booth speakers for the DJ with separate gain controls for each output. It also facilitates smooth transitions between DJs.

However, using an external mixer with internal mixing is not necessary and reduces the sound quality. Each piece of equipment an audio signal passes through reduces the sound quality, so avoiding unnecessary equipment in the signal path can provide better sound quality. Many DJ controllers provide separate master and booth outputs with independent volume controls. Alternatively, a sound card with at least 6 output channels can be used with Mixxx's *Booth* output.

Many people confuse «analog mixers» and «hardware mixers», but these are not the same. Many hardware mixers process audio digitally with specialized signal processors as opposed to a general purpose CPU like those in laptop and desktop computers.

### Vedi anche:

*Recording And Broadcasting With An External Hardware Mixer*

## 5.4 Turntables

Turntables are mechanical devices that play music recordings cut into vinyl phonograph records. Before software like Mixxx was available, the art of DJing originated with turntables and *DJ mixers*. Special vinyl records can be used with turntables to control the playback of digital files in Mixxx as if the digital file was pressed onto the vinyl record.

### Vedi anche:

*Controllo Vinile*

## 5.5 CDJs

CDJs are devices that play digital audio files and have controls from manipulating the playback of the audio. Originally CDJs played audio CDs, but new devices typically use USB storage drives or SD cards. Some CDJs can be plugged into a computer with a USB cable to function as a *controller* for Mixxx.

## 5.6 Microphones

Microphones convert changes in sound pressure in air to changes in voltage (an analog audio signal). Mixxx can work with any microphone that can be plugged into your *audio interface*.

### Vedi anche:

*Using Microphones*

## 5.7 Headphones

Being able to listen to what you will play next in headphones before your audience hears on the main speakers or your broadcast stream is an essential part of DJing. DJ headphones are generally better quality than typical consumer headphones. Importantly, they are designed to have good isolation, meaning they block outside sound. This allows the DJ to focus on the sound in the headphones better without having to turn up the volume to drown out sound from the monitors, PA system, and chatter. Also, DJ headphones have hinges or flexible headbands that allow the DJ to take off one headphone cup to hear the monitor or PA output better in one ear and compare it to the headphone output in the other ear.

When shopping for headphones, consider how well they isolate sound and their durability. The most frequent places that headphones break are the cable attachment point and the headband. Look for headphones with detachable cables, metal headbands, and other individually replaceable parts. Avoid Bluetooth headphones because these may be unreliable and will always reduce sound quality. Active noise canceling headphones also tend to have worse sound quality than other headphones of a comparable price. DJ headphones with a closed design block out a lot of sound simply by being closed.

Whether to get on-ear or over-ear headphones is a matter of personal preference. Everyone's head is different, so headphones that are comfortable for a friend or a reviewer may not be comfortable for you.

In-ear monitors (IEMs) isolate sound better than headphones but are more expensive. They usually cost more than double the price of good DJ headphones with comparable quality. They may be a sound investment for musicians who play often in very loud environments to preserve their hearing.

## 5.8 Splitter Cables

DJ splitter cables are the cheapest way to get two separate sound outputs from your computer. These plug into the onboard audio interface built into computer motherboards and split the stereo signal into two separate mono signals. However, onboard audio interfaces are not good quality, and you lose the stereo effect of hearing different sounds arranged in space.

Devices marketed as «headphone splitter» instead of DJ splitters duplicate one stereo signal in two jacks. These cannot be used for headphone cueing. Also, generic stereo-to-mono splitter cables or adapters typically have two mono jack outputs. Plugging headphones or stereo speakers into a generic stereo-to-mono splitter will only play sound on one side of the headphones or speakers.



---

## Example Setups

---

This chapter presents some example hardware setups with instructions for how to configure Mixxx to work with them.

**Vedi anche:**

- *DJ Hardware*: background information about different types of equipment.
- *Configuring sound input and output*: details about each available input and output option.
- *Using Microphones*: details for configuring Mixxx to work with microphones.
- *DJ Hardware Guide* lists specific devices with information about their prices, features, and compatibility with Mixxx.

## 6.1 Computer Only

The built-in audio interface on most computers comes with a single stereo line-out and a microphone input. This can be set up with Mixxx in two ways:

### 6.1.1 Practicing Mixing / Broadcasting

This setup can be used with a single audio output for speakers or headphones to practice DJing without investing in any equipment other than a computer and a set of speakers or headphones. With this configuration, use the *Pre/Main Knob* to switch back and forth between the Master mix and *PFL* signal. This setup cannot be used to play for a live audience because the Master mix is not sent to an audio interface output. However, it can be used by radio DJs who only need to send the Master mix to a broadcast audience.

1. Open *Preferences* ▶ *Sound Hardware*
2. Select the *Output* tab
3. From the *Headphones* drop-down menu, select your built-in audio interface, then *Channels 1-2*. Although this is labeled *Headphones*, you can also plug speakers into the output jack of your computer.
4. Depending on your audio interface, you can specify a *microphone*

- a. Use your built-in microphone or connect a microphone to your computer
  - b. Check that your microphone is detected by your *OS*
  - c. Open the *Input* tab
  - d. From the *Microphone* drop-down menu, select the input your microphone is connected to
5. Click *Apply* to save the changes.

## 6.1.2 Playing for an Audience

This setup allows for playing to an audience without headphone *cueing*.

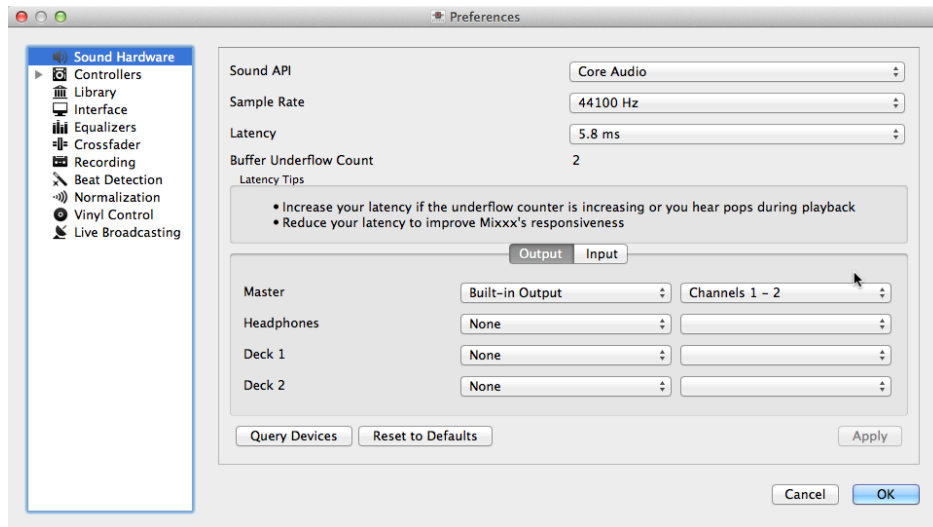

Figure 1: Using Mixxx with your built-in sound card

1. Open *Preferences* ▶ *Sound Hardware*
2. Select the *Output* tab
3. From the *Master* drop-down menu, select your built-in audio interface, then *Channels 1-2*
4. Depending on your audio interface, you can specify a *microphone*
  - a. Use your built-in microphone or connect a microphone to your computer
  - b. Check that your microphone is detected by your *OS*
  - c. Open the *Input* tab
  - d. From the *Microphone* drop-down menu, select the input your microphone is connected to
5. Click *Apply* to save the changes.

## 6.2 Laptop and Splitter Cable

The cheapest way to DJ and *cue* with headphones uses a stereo-to-mono DJ splitter cable (also known as a “Y cable”) plugged into the headphone jack of a laptop or other computer. This cable divides the stereo output from a single jack into two separate mono signals.

This setup allows you to start DJing without having to invest in expensive equipment. However, because the signals are in mono, you and your audience will not be able to enjoy music producers’ positioning of sound in space (although many club PA systems are wired in mono anyway). Furthermore, audio interfaces built into computers are usually low quality and often pick up interference from other components of the computer.

### Using a built-in audio interface and a stereo-to-mono splitter

1. Open *Preferences* ▶ *Sound Hardware*
2. Select the *Output* tab
3. Check that your headphones are plugged into the side of the cable with a headphones symbol and that the speakers are plugged into the side of the cable with a speaker symbol.
4. From the *Master* drop-down menu, select your built-in audio interface, then *Channel 1*
5. From the *Headphones* drop-down menu, select your built-in audio interface, then *Channel 2*
6. Click *Apply* to save the changes.

**Avvertimento:** Most splitter cables, particularly those marketed as headphone splitter cables, output the same stereo signal to two headphone jacks and will not work for this DJ setup. Also, if you use a generic stereo-to-mono splitter adapter, you may only be able to hear out of one side of your speakers and headphones. DJ splitter cables allow you to hear the same mono signal on both sides of your headphones and speakers.

## 6.3 Laptop and External USB Audio Interface

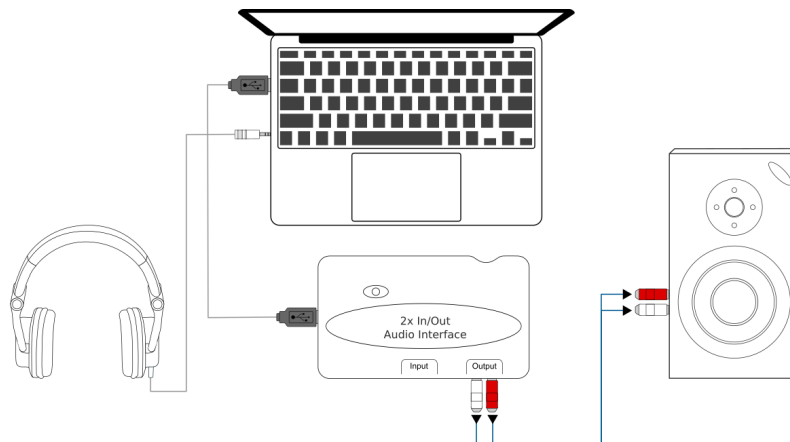

Figure2: Using Mixxx together with an external audio interface

### Using two audio interfaces (built-in + external)

1. Open *Preferences* ▶ *Sound Hardware*
2. Select the *Output* tab

3. From the *Master* drop-down menu, select the external audio interface, then *Channels 1-2*
4. From the *Headphones* drop-down menu, select the built-in audio interface, then *Channels 1-2*

#### Using an external multi-channel audio interface

1. Open *Preferences* ▶ *Sound Hardware*
2. Select the *Output* tab
3. From the *Master* drop-down menu, select the external audio interface, then *Channels 1-2*
4. From the *Headphones* drop-down menu, select the external audio interface, then *Channels 3-4*
5. Click *Apply* to save the changes.

## 6.4 Laptop and MIDI or HID Controller

### Vedi anche:

The *Controllers* section of the *DJ Hardware* chapter has background information about controllers.

### 6.4.1 Controllers with an integrated audio interface

Many DJ controllers include an integrated *multi-channel* audio interface. A setup with this kind of controller may look like the diagram below:

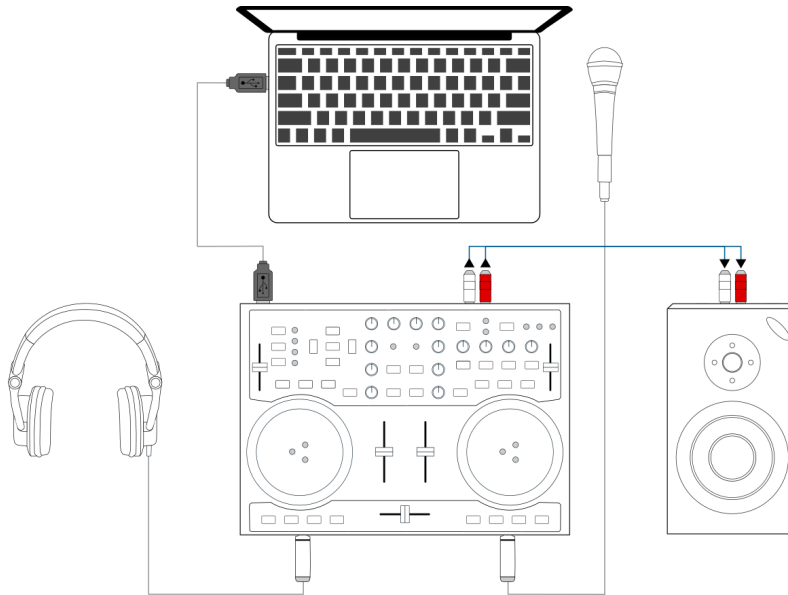

Figure3: Using Mixxx together with a DJ controller and integrated audio interface

#### Using a controller with an integrated multi-channel audio interface

1. Open *Preferences* ▶ *Sound Hardware*
2. Select the *Output* tab
3. From the *Master* drop-down menu, select your controller's audio interface, then *Channels 1-2*
4. From the *Headphones* drop-down menu, select your controller's audio interface, then *Channels 3-4*

5. Click *Apply* to save the changes.

## 6.4.2 Controllers without an integrated audio interface

Controllers without an integrated audio interface can be used together with a USB audio interface as depicted in the diagram below:

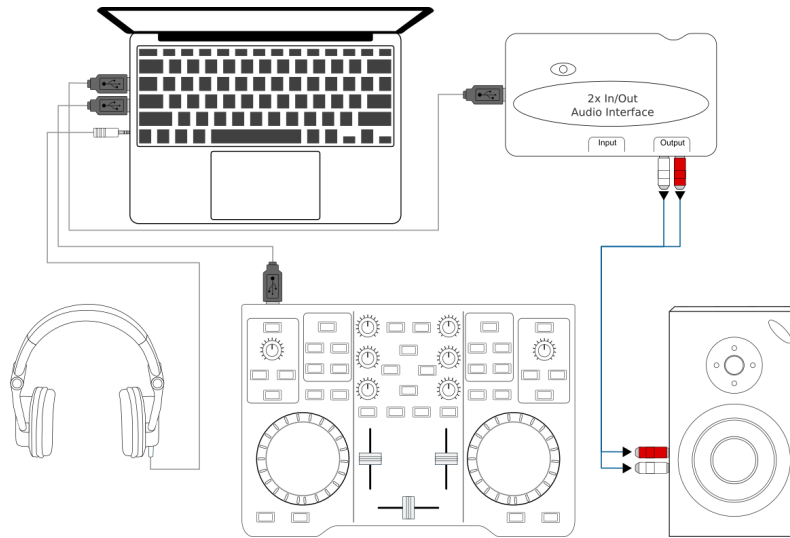

Figure4: Using Mixxx together with a DJ controller and external audio interface

### Using a controller without an integrated audio interface

1. Open *Preferences* ▶ *Sound Hardware*
2. Select the *Output* tab
3. From the *Master* drop-down menu, select the external audio interface, then *Channels 1-2*
4. From the *Headphones* drop-down menu, select the built-in audio interface, then *Channels 1-2*
5. Click *Apply* to save the changes.

## 6.5 Laptop, External Hardware Mixer and Vinyl Control

This setup allows DJs to use the techniques of DJing with vinyl record turntables combined with the portability and flexibility of a laptop computer. Instead of carrying crates of records or CDs, DJs can carry their entire music collection on their laptop. In addition to a laptop and headphones, this setup requires an audio interface with at least two pairs of stereo inputs and outputs as well as a pair of *timecode* records.

### Vedi anche:

Go to the chapter *Controllo Vinile* for detailed information.

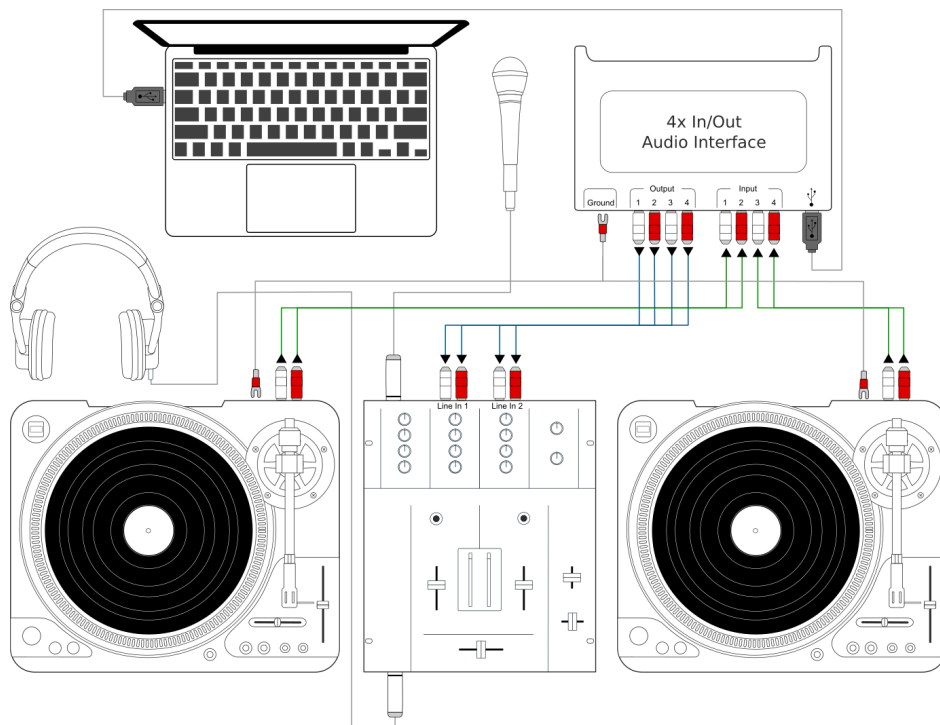

Figure5: Using Mixxx together with turntables and external mixer

Mixxx can be controlled with a keyboard, a mouse, *MIDI/HID* controllers, time-code records/CDs, or a combination of these. The choice usually depends on your budget or style of DJing.

### 7.1 Using a Mouse and Touchpad

Use your mouse to interact with the controls in the *Mixxx User Interface* on your computer screen. You can perform actions by pointing and clicking with your mouse.

- **Single Left Click:** Performing a left mouse click on buttons triggers the default action for that control. Moreover if you click on a value in the track list of the Mixxx *library*, you can change the value. For example the year of a track.
- **Single Right Click:** On most buttons, performing a right click triggers a different action than a left click. You can return any knob or fader to its default value by right-clicking that control.
- **Mouse Drag:** Click on a knob or fader, hold the left mouse button and move your cursor to change the value of the control. Use mouse drag to drop tracks from the file list to the decks, crates, playlists, etc.
- **Mouse Wheel:** Just like Mouse Drag, you can change knob and fader values by placing the cursor over the control and moving the mouse wheel.

---

**Suggerimento:** If you hover with the mouse over a control (e.g. the crossfader) in the Mixxx user interface, the tooltip lists the left- and right-click action respectively.

---

---

**Suggerimento:** On a Macbook or a computer with a touchpad that lacks mouse buttons, a two-finger click gesture is often treated as a right click.

---

**Vedi anche:**

Using the Mouse drag/wheel on the waveforms you can adjust zoom and playback rate of the tracks. For more information,

go to [Waveform Displays](#).

## 7.2 Using a Keyboard

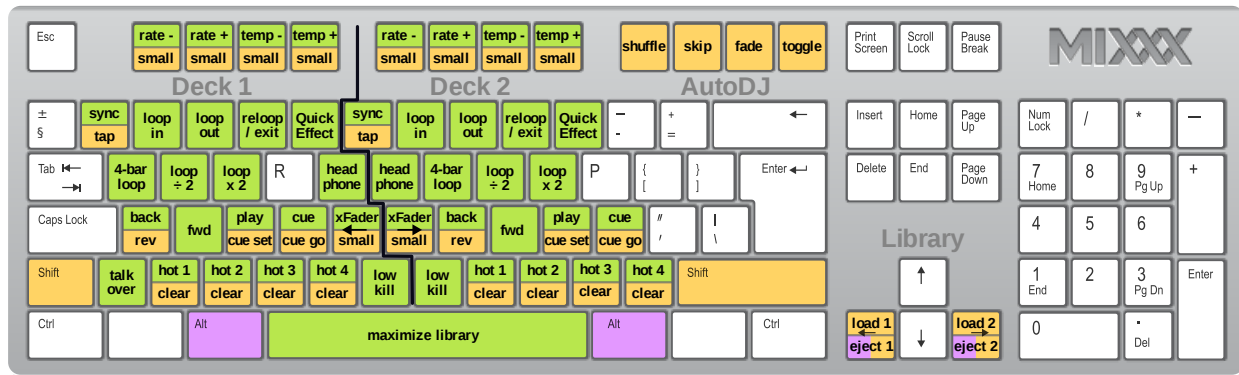

Figure 1: Mixxx Keyboard shortcuts (for en-us keyboard layout)  
[Download the image](#)

Controlling Mixxx with a keyboard is handy. Unlike mouse control, the keyboard allows you to manage things simultaneously. For example, you can start playing a track on deck 1 whilst stopping deck 2 at the same time.

The default mapping for English keyboards is depicted in the figure above. It is divided into a left-hand side for deck 1 and right-hand side for deck 2. Please note that you can also access the functions through Mixxx’s interface.

For some user groups, like those using [controllers](#) or [vinyl control](#), it might be useful to enable/disable the keyboard mappings at runtime. You can do so by clicking [Options](#) ▶ [Enable Keyboard Shortcuts](#).

---

**Suggerimento:** If you hover with the mouse over a control (e.g. the crossfader) in the Mixxx user interface, the tooltip lists the keyboard shortcuts of the control among a description of the control.

---

### Vedi anche:

For a list of default shortcuts, go to [Keyboard mapping table](#).

### 7.2.1 Customizing the keyboard mapping

Mixxx allows you to customize the keyboard control. For more information, go to:

- [Making a Custom Keyboard Mapping](#)



## 7.3 Using MIDI/HID Controllers

Mixxx supports MIDI and HID *controllers* which are external hardware devices used to control audio applications. Many DJs prefer the hands-on feel of a controller with Mixxx because it can feel similar to using a real mixer and turntables or *CDJ*.

### 7.3.1 Loading a controller mapping

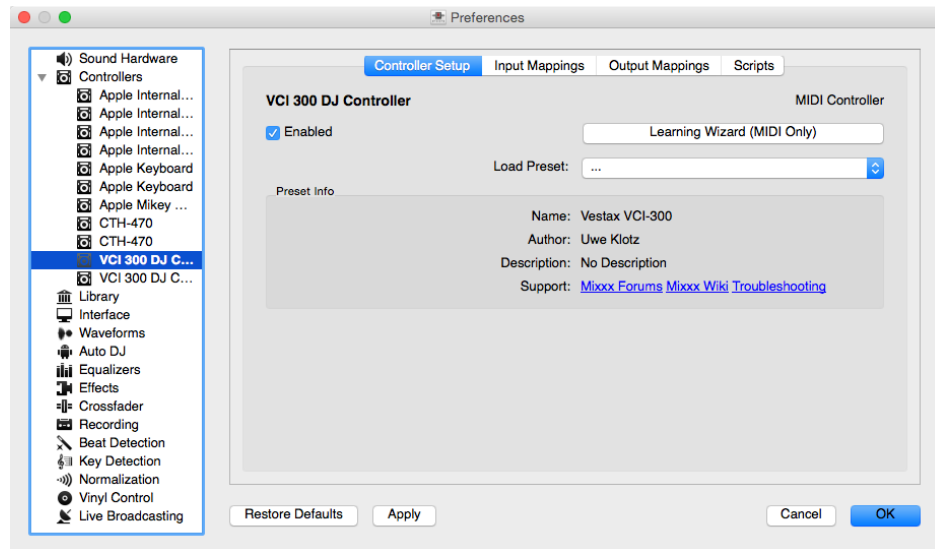

Figure2: Mixxx Preferences - Loading a controller mapping

Without loading the correct mapping, your controller does not work with Mixxx.

1. Connect your controller(s) to your computer
2. Start Mixxx
3. Go to *Preferences* ▶ *Controllers*
4. Select your device from the list of available devices on the left, and the right pane will change
5. Select the mapping for your controller from the *Load Mapping* drop-down menu
6. Make sure that the *Enabled* checkbox is ticked
7. Click *Apply* and Mixxx can now be controlled by your controller(s).
8. Repeat step 4-7 for any of the controllers you want to use

---

**Suggestion:** If you do not find a connected device in the list, make sure to install any necessary drivers for that device.

---

### 7.3.2 Supported controllers

Mixxx can use any *MIDI/HID* controller that is recognized by your *OS* (some may require drivers), as long as there is a MIDI/HID mapping file to tell Mixxx how to understand it. Mixxx comes bundled with a number of mappings for various devices. There are two levels of controller mappings:

- **Mixxx Certified Mappings:** These mappings are verified by the Mixxx Development Team.
- **Community Supported Mappings:** These mappings are provided and have been verified as working by the Mixxx community, but the Mixxx Development Team is unable to verify their quality because we don't have the devices ourselves. They might have bugs or rough edges.

If you run into issues with any of these mappings, please file a *bug report* on our [Bug Tracker](#) or tell us about it on our mailing list, forums, or *IRC* channel. Device support varies for each supported *OS*, so make sure to consult the documentation of the device.

---

**Suggerimento:** Additional mappings are available in the [Controller mapping forum](#).

---

#### Vedi anche:

Before purchasing a controller to use with Mixxx, consult our [Hardware Compatibility wiki page](#). It contains the most up-to-date information about which controllers work with Mixxx and the details of each.

### 7.3.3 Installing a mapping from the forum

To use a controller mapping that did not come bundled with Mixxx, place the controller mapping in your User Mappings folder. This is the folder called «controllers» inside your User Preferences folder. To open your User Mappings folder, go to *Preferences* ▶ *Controllers* and click the *Open User Mapping Folder* button. Alternatively, navigate to the folder in your *OS* file browser:

- GNU/Linux: `/home/<username>/.mixxx/controllers`
- macOS: `/Users/<username>/Library/Containers/org.mixxx.mixxx/Data/Library/Application Support/Mixxx/controllers`
- Windows Vista and newer: `C:\Users\<username>\AppData\Mixxx\controllers`
- Windows XP: `C:\Documents and Settings\<username>\AppData\controllers`

On Windows, the `AppData` folder is hidden, so if you have not already, you will need to set Windows Explorer to show hidden files and folders (how to do this varies with each version of Windows).

If the mapping was posted as a `.zip` file, first extract the `.zip` file by right clicking on it in your file browser and selecting the option for extracting an archive or compressed folder. Copy the `.xml` file into your User Mapping folder. If there is a `.js` file, also copy that to your User Mapping folder. Restart Mixxx and *load the mapping*.

### 7.3.4 Map your own controller

There is no mapping available for your controller or you want to change an existing mapping? You can map your controller by using the Controller Wizard or take full control with the MIDI Scripting support in Mixxx.

#### Vedi anche:

Go to *Con diverse dozzine di controller DJ supportati immediatamente, Mixxx offre un controllo hardware completo per i tuoi mix DJ, vedi: ref: control-midi*. for detailed information.

## 7.4 Using Timecode Vinyl Records and CDs

*Vinyl control* allows a user to manipulate the playback of a track in Mixxx using a turntable or *CDJ* as an interface. In effect, it simulates the sound and feel of having your digital music collection on vinyl. Many DJs prefer the tactile feel of vinyl, and vinyl control allows that feel to be preserved while retaining the benefits of using digital audio.

**Vedi anche:**

Go to *Controlli Vinile* for detailed information.

Vinyl control allows a user to manipulate the playback of a track in Mixxx using a real turntable as a controller. In effect, it simulates the sound and feel of having your digital music collection on vinyl. Many DJs prefer the tactile feel of vinyl, and vinyl control allows that feel to be preserved while retaining the benefits of using digital audio.

### 8.1 How does it work?

Vinyl control uses special *timecode* records or CD's which are placed on real turntables or *CDJ*. The audio output of the turntables is plugged into a audio interface connected to a computer on which Mixxx is running. When a record is played on one of the attached turntables, Mixxx reads the timecode from the record and uses the information to manipulate whatever track is loaded.

### 8.2 What do I need to use it?

It is possible to use Mixxx's vinyl control with a variety of setups. Unlike some proprietary DJ software, Mixxx can use several types of timecode media and any audio interface that your *operating system* has drivers to use. Optionally, any *MIDI/HID controller* can be used together with timecode control. The basic setups for timecode control are:

#### Setup 1: Vinyl DJ

2-4 timecode vinyls, 2-4 turntables with phono pre-amplifiers (or line-level output), and 2-4 stereo sound inputs.

Your audio interface inputs must match the turntable outputs. Turntables output very quiet phono-level outputs that must be amplified for Mixxx to use. You should either find a audio interface that has phono pre-amplifiers built in (one for each deck), use standalone phono pre-amplifiers, or use turntables with built in phono pre-amplifiers.

You can try skipping the phono pre-amps if you use the software pre-amp in Mixxx on the Vinyl Control preferences pane. This may not work for everyone. Line-level signals are preferred and recommended.

For turntables a typical setup is depicted in the figure below. First, connect the RCA cables from the turntables to the inputs on your audio interface. Second, connect the outputs of your audio interface to the inputs on your mixer.



Figure1: Using Mixxx together with turntables and external mixer

**Nota:** Many modern turntables have a *Line/Phono* select switch. If yours does, make sure it matches the input or switch setting on your sound card.

## Setup 2: CDJ

2-4 timecode CDs, 2-4 CD decks, and 2-4 stereo sound inputs.

Setting up CDJs for use with timecode CDs is similar to setting up turntables. The figure below outlines a typical configuration. First, connect the RCA cables of the CDJs to inputs of your audio interface. Second, connect the inputs of your mixer to the outputs of your audio interface. Make sure the input mode of your audio interface is set to *Line*.

### Sound inputs

- It is recommended to use a DJ audio interface that has **multiple** stereo line inputs on it.
- Alternatively you can use multiple audio interfaces, each with a single stereo line in, but this is strongly discouraged.

Mixxx supports vinyl control input through a single audio interface with at least 4-channels of input (two stereo line-in jacks), or through multiple separate audio interfaces which each have 2-channels of input (a single stereo line-in jack). Vinyl control requires the use of stereo line-in jacks - Mono or microphone inputs will not work.

It is strongly recommended to use a audio interface that comes with native low latency drivers such as ASIO (Windows) or CoreAudio (Mac). Linux users depend on the quality of the corresponding open source driver.

**Nota:** For best scratch performance with vinyl control, we recommend using a system capable of *latencies* of 10ms.

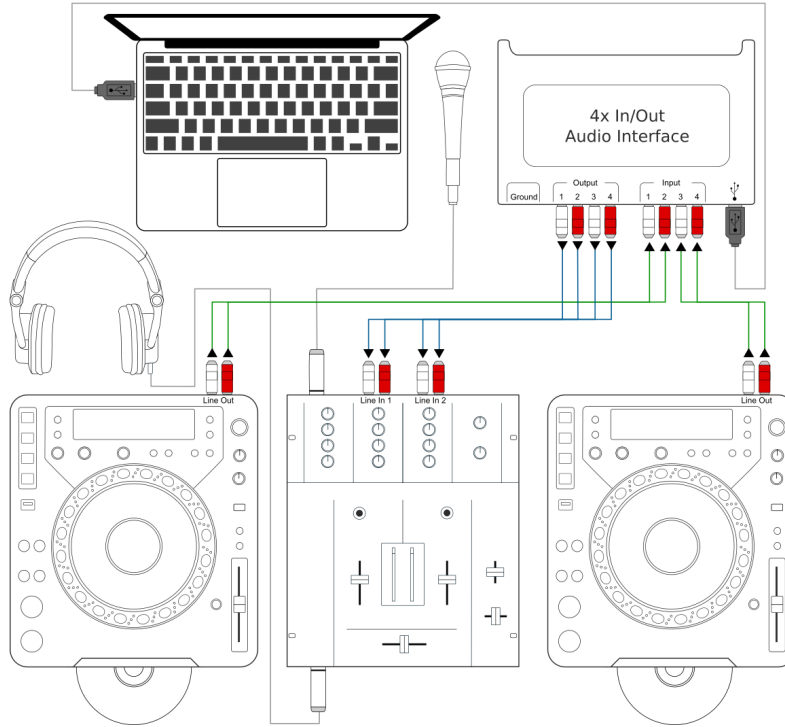

Figure2: Using Mixxx together with CDJs and external mixer

With higher latencies the scratch sound will start to become distorted.

**Nota:** An external hardware mixer is not required for using timecode control. You can use a *MIDI or HID controller* to mix in software instead.

### 8.2.1 Supported Timecode media

You can use any of the timecode media supported by Mixxx:

| Digita                    | Responsiveness |
|---------------------------|----------------|
| Serato CV02/2.5 Vinyl     | Very high      |
| Serato Control CD 1.0     | Very high      |
| Traktor Scratch MK1 Vinyl | Very high      |
| Traktor Scratch MK2 Vinyl | Not supported  |
| MixVibes DVS V2 Vinyl     | Very high      |

At the present time, Serato records are recommended if you are looking to buy vinyl. If you want to use CDs, you can download a free copy for personal use from [Serato](#).

## 8.3 Configuring Input and Output devices

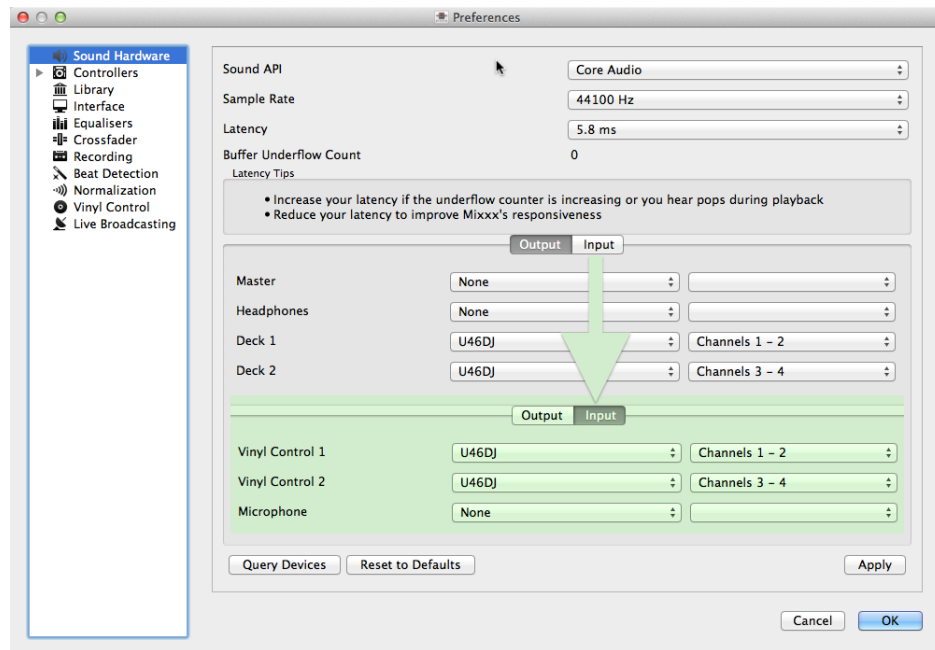

Figure3: Mixxx preferences - Setting up Input and Output devices for Vinyl Control

Mixxx can be controlled by up to 4 decks with either timecoded vinyl or timecoded CDs.

1. Open *Preferences* ▶ *Sound Hardware*
2. Select the *Input* tab
3. From the *Vinyl Control 1 - Vinyl Control 4* drop-down menus, select the audio interface(s) which your decks are plugged into.
4. In the channel selection drop-down menu, select the channel pairs corresponding to the plug on your audio interface that your deck(s) are plugged into, typically *Channels 1-2* and *Channels 3-4* etc.
5. Click *Apply* to save the changes.
6. Select the *Output* tab
7. Specify *Deck 1 - Deck 4* to route Mixxx's output directly to the external mixer
8. Click *Apply* to save the changes.

## 8.4 Configuring Vinyl Control

You can configure vinyl control in *Preferences* ▶ *Vinyl Control*.

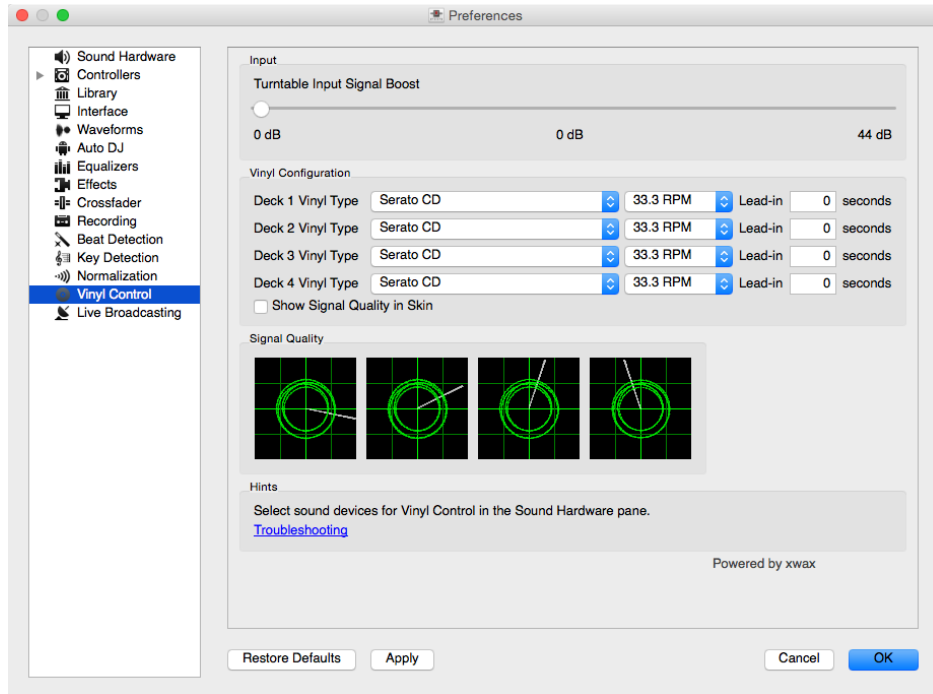

Figure4: Mixxx preferences - Setting up vinyl control

### 8.4.1 Incremento Segnale Input Piatti Vinile

Many turntables provide unamplified “phono level” output which must be boosted to a “line level” signal. Normally, a mixer or audio interface provides this amplification, but if you’re plugging a turntable’s phono output directly into a audio interface that doesn’t support phono input, Mixxx can do the amplification. The *Turntable Input Signal Boost* slider allows you to adjust the level of preamplification applied to your decks’ signal. However, it is always preferable to use a proper phono preamplifier if you have one.

### 8.4.2 Configurazione Vinile

- **Vinyl Type:** Several types of timecoded media can be used to control Mixxx. Configure the drop-down menus to match what type of timecoded media you are using on your decks.
- **Deck Vinyl Tempo:** Change this if you prefer to scratch with your turntable or CDJ set at 45 RPM, default is 33 RPM.
- **Lead-in Time:** Allows you to set a dead-zone at the start of your vinyl or CD, where the time code will be ignored. This is useful in situations where the time code begins very close to the edge of a vinyl which can make back-cueing over the first beat in a track tricky to do without your turntable’s needle falling off the vinyl. Setting a lead-in time of 20 seconds or more helps alleviate this by giving you more room on the vinyl to cue with. It’s also useful when you’ve worn the grooves at the edge of a control record to the point that it no longer works reliably: you simply set the lead-in so that the start of the tracks begin in good groove area. You can keep doing this until you run out of groove area, thereby decreasing your record replacement frequency.
- **Show Signal Quality in Skins:** If enabled, a circular representation of the incoming timecode signal is displayed in real-time on the *Vinyl Widget* in the Mixxx Interface.

---

**Suggerimento:** Although not recommended, you can use different kinds of timecode media per deck.

---



### 8.4.3 Modalità controllo

Mixxx has three control modes regardless of which control records you use.

- **Absolute Mode:** Provides Mixxx with both pitch and position information from the timecode, and allows you to seek by needle dropping on your vinyl or seeking on your CDJ.
- **Relative Mode:** Takes the position to be relative to your deck's starting point, and only controls the pitch in Mixxx. It is not possible to seek using your deck in relative mode, with one exception. If you drop the needle in the *Lead-in Time* area (see *Vinyl Configuration*), Mixxx will seek back to the beginning of the track. Once a track is playing in Relative Mode, Mixxx will not allow you to select Absolute mode. Otherwise, the track would suddenly jump to a new position. Make sure the record is stopped and then you're free to select Absolute mode.
- **Constant Mode:** This special mode is usually only activated when Mixxx needs to keep playing a track even if the vinyl control signal isn't present. Constant mode is automatically enabled when the needle reaches the end of a vinyl control record.

### 8.4.4 Cueing Modes

Mixxx has two optional cueing modes for vinyl control which **only** apply to **Relative Mode**. These modes are useful for quickly seeking to specific positions in a track without touching the laptop. Turntablists often need to find a break or a vocal sample, and cueing modes make these easy to find.

- **Cue:** In this mode, when you drop the needle on the record *after* the Cue point, Mixxx will seek to that cue point.
- **Hot Cue:** When the needle is dropped Mixxx will seek to the nearest hotcue point, working backwards. So if you have a hotcue at the one-minute mark, and another at the two-minute mark, you can drop the needle anywhere between one and two minutes and Mixxx will seek to the one-minute hotcue.

---

**Suggerimento:** You can change the Control and Cueing Modes directly in the Mixxx user interface while mixing, go to *Vinyl Control Mode and Cueing controls*. Alternatively, use the *Application shortcuts*.

---

### 8.4.5 Qualità del segnale

A successful vinyl control setup hinges on good signal quality. Many factors can affect signal quality, but the most important one is ensuring the volume level of your timecode signal is moderate. A signal that is too loud or too quiet will cause adverse performance, often characterized by a loss of position data causing absolute mode to behave like relative mode.

Mixxx represents the quality of the timecode signal as a circular graphic coming from the vinyl control audio itself. The graphs correspond to your active input devices *Deck 1 - Deck 4*.

If your vinyl signal is working, you should see a round, green circle drawn with two lines. This vinyl “doughnut” should be as circular as possible, and the lines should be clear with a minimum amount of fuzz.

---

**Suggerimento:** You can display the signal quality in the Mixxx user interface while mixing, see *Configuring Input and Output devices*.

---

## 8.5 Enabling Vinyl Control

For each deck, select *Options* ▶ *Vinyl Control* ▶ *Enable Vinyl Control*, or use the *Application shortcuts*.

### 8.5.1 Vinyl Control Status Display



Figure5: The vinyl control status, and signal quality display of the deck

A rectangle provides visual feedback with regards to vinyl control status of a deck.

- **Off:** Vinyl control disabled on the deck.
- **Green:** Vinyl control is enabled on the deck.
- **Yellow:** The needle has reached End-Of-Record.

## 8.6 Single Deck Control

If you only have one turntable, you can still use Mixxx to play your sets. In the *Preferences* ▶ *Sound Hardware* ▶ *Input* tab, use the same audio input for both *Vinyl Control* decks.

When mixing, you'll have one track playing automatically while the other is controlled by the turntable. Start by enabling vinyl control on the first deck, and start mixing. When you're ready to cue up the next record, just disable vinyl control on the first deck and enable it on the second deck. Playback will continue on the first deck without interruption. Cue up the second track and mix it in. When you're ready to cue the first deck again, just toggle the second deck off and the first deck on again.

Use the *Application shortcuts* to swap focus from one deck to the other. Alternatively, select *Vinyl* ▶ *Single Deck mode* in the *Controller Wizard*, to assign the control to a key on your controller.

## 8.7 End-Of-Record Mode

Sometimes the track you are playing is longer than the timecode area on your record. If the needle reaches the end of the vinyl timecode, Mixxx will enter a special *End-Of-Record Mode*. When this happens, the vinyl indicator (usually a green rectangle) will blink yellow as a warning. At the same time, Mixxx will automatically enable *Constant Mode* and will ignore the turntable's pitch. At this point the track will simply continue playing until the end. When you load a new track, *End-Of-Record Mode* will be automatically disabled and *Constant Mode* turned off.

When you're in *End-Of-Record Mode* and you want to still use the turntable for pitch control, simply lift the needle and place it anywhere in the main timecode area. It's OK, the track won't stop playing. As soon as Mixxx detects that the needle has settled, it will automatically switch to *Relative Mode*.

## 8.8 Control Track

Some vinyl control records have a special portion of grooves near the center of the record for selecting and loading tracks in the user interface. You can see these grooves because there is a gap between the main timecode area and the inner circle. Some control records have not been tested with Mixxx, and their control areas are not supported. Serato CV02 Vinyl and Traktor Vinyl MK1 are known to work. Serato CV02 CDs are known not to work.

Just drop the needle in the control area and let the record play forward or backward. The highlighted row in the library should move up or down. Simply lift the needle and drop it anywhere in the main timecode area to load the track.

## 8.9 Risoluzione dei problemi











### Configuration

To complete your setup you must configure Mixxx properly. Make sure you have:

- specified *Deck 1 - Deck 4* in *Preferences* ▶ *Sound Hardware* to route Mixxx's output directly to the external mixer
- specified *Vinyl Control 1 - Vinyl Control 4* under *Preferences* ▶ *Sound Hardware* ▶ *Input*
- selected the correct control type under *Preferences* ▶ *Vinyl Control* ▶ *Vinyl type* in the preferences. See the list of [Supported Timecode media](#)
- enabled vinyl control via the menu under *Options* ▶ *Vinyl Control* ▶ *Enable Vinyl Control*.

### Signal Quality

The graph is displayed in *Preferences* ▶ *Vinyl Control*, see [Qualità del segnale](#).

| Signal  | Meaning   | Risoluzione dei problemi   |
|---|---|--|
|    | Vinyl control input channels not correctly set up. Vinyl control will not work.   | Open Preferences/ Sound Hardware and set up the devices you want to use, see <i>Configuring Input and Output devices</i>                                 |
|    | Vinyl control input channels set up correctly. Waiting for timecode input signal.   | Start your turntable or CDJ with the selected timecode vinyl or CD.  |
|    | Nearly perfect green doughnut about half the width of the graph. Rotating radar sweeps in the direction your record on the turntable is spinning. | Everything is OK, nothing to do. Go spin some beats.   |
|    | Incorrect choice of vinyl control source. Doughnut looks good but has a solid red color.  | Select the correct vinyl type in the preferences. E.g. maybe you selected side B of the Serato Vinyl but your record is on side A.                       |
|    | Input signal is bad. As the vinyl signal gets worse, you'll see the color of the doughnut change from green over orange to red.                   | Check the wiring / grounding on your turntable / CDJ. Your timecode record / CD might be worn out or the needle on your turntable is dirty.              |
|    | Wrong direction. The green doughnut looks good but the radar sweeps in the opposite direction of the record on your turntable / CDJ.              | You probably have a wiring problem. Try reversing the left and right inputs on your turntable. You may also have to rewire the headshell.                |
|   | Input signal is no timecode signal. Mixxx receives a normal audio signal while it expects a timecode signal.                                      | Start your turntable or CDJ with the selected timecode vinyl or CD. You may want to check if the inputs devices are set up correctly in the preferences. |
|  | Left or right channel is missing. Mixxx receives only a mono signal but needs a stereo timecode signal to operate.                                | Check the wiring on your turntable / CDJ and also the headshell and needle on your turntable.  |
|  | Timecode signal too loud. Mixxx receives a signal which has too much amplification.   | Lower the amplification, either on your external mixer, audio interface, or with the <i>Turntable Input Signal Boost</i> .                               |
|  | Timecode signal too quiet. Mixxx receives a signal which has not enough amplification.  | Boost the amplification, either on your external Mixer, audio interface, or with the <i>Turntable Input Signal Boost</i> .                               |

---

## Using Microphones

---

Mixxx can work with any microphone that can be plugged into your *audio interface*. There are three ways to use microphones with Mixxx, each with their own pros and cons:

- *Software Monitoring*: Cheapest and simplest to set up, but you cannot hear yourself without a disorienting delay, referred to as «latency».
- *Direct Monitoring*: Recommended for most users. This is the cheapest to set up with good sound quality and without the latency of software monitoring.
- *Hardware Mixers*: Most expensive option to set up with high sound quality. This does not have the latency of software monitoring.

**Avvertimento:** USB microphones are not recommended. These devices have their own audio interface built in and can only be used with software monitoring. Some USB microphones have headphone jacks for direct monitoring, but the music from Mixxx cannot be heard in this headphone jack. Also, they can be difficult to configure at the same time as a different audio interface for music output.

### Vedi anche:

The [Mixxx DJ Hardware Guide](#) lists specific audio interfaces with information about their prices, features, and suitability for use with microphones.

## 9.1 Software Monitoring

Software monitoring can be used with the built-in microphone on a laptop or with a headset plugged into the built-in audio interface on a computer. However, there is a delay between the time you make sound into the microphone and hear it in the Master output. Due to the nature of digital audio, it takes time for input from the audio interface to be available for Mixxx to process, time for Mixxx to process the audio, and more time to send the audio back out the audio interface. This time is referred to as «latency».

Mixxx can be configured to run at low latencies by choosing a smaller *Buffer Audio*, but there is no way to completely eliminate latency. Although latency is measured in milliseconds, even a few milliseconds of latency can be disorienting

and distracting to hear, whether you are using the microphone for spoken announcements, vocals, or playing a musical instrument.

To use software monitoring:

1. Open *Preferences* ▶ *Sound Hardware*.
2. Select the *Input* tab.
3. For *Microphone 1*, select the audio interface that your microphone is plugged into.
4. Click the *Apply* button.
5. Click the *OK* button.
6. Click the *Mics* button in the main Mixxx window to show the microphone controls.
7. Click the *Talk* button when you are using the microphone.

---

**Suggestion:** If you would prefer to not hear the microphone input, you can set the *Microphone Monitor Mode* option to *Direct monitor (recording and broadcasting only)*. This will still mix the microphone input with your recorded and broadcasted mixes, but it will not mix the microphone with the Master output. Don't forget to press the *Talk* button when using the microphone if you use this option.

---

## 9.2 Direct Monitoring

An audio interface with direct monitoring and a *Loopback Input* is the recommended way to use microphones with Mixxx for most users. Except for audio interfaces built into computers, most audio interfaces with microphone inputs support direct monitoring. However, not all audio interfaces that support direct monitoring also have a loopback input.

Direct monitoring routes the audio from the audio interface's inputs directly its outputs. This avoids the latency of sending it into the computer and back out with *Software Monitoring*. At the same time, the audio interface sends the input into the computer so Mixxx can record and broadcast it.

### 9.2.1 Loopback Input

Some audio interfaces that support *Direct Monitoring* have a loopback input feature. They add Mixxx's output to the microphone signal before sending it to the computer. This makes it easier to set up Mixxx with direct monitoring than configuring *Latency Compensation*.

To configure Mixxx with a loopback input:

1. Open *Preferences* ▶ *Sound Hardware*.
2. Click the *Input* tab.
3. Select the audio interface for the *Record/Broadcast* input. Do not configure anything for the *Microphone 1-4* inputs.
4. Click the *Apply* button.
5. Click the *OK* button.
6. *Activate direct monitoring and loopback on your audio interface.*
7. Adjust the microphone volume with the input gain knob on your audio interface.

The microphone controls in Mixxx will not affect your microphones because they are mixed by the audio interface and not sent directly to Mixxx.

## 9.2.2 Latency Compensation

When using *Direct Monitoring*, you will hear the microphone mixed with the music from Mixxx without any noticeable latency. However, it still takes time for Mixxx to receive the microphone signal and process it. Without compensating for this latency or using a *Loopback Input*, the microphone inputs will be out of time relative to the music in your recorded and broadcasted mixes.

Mixxx can compensate for this timing misalignment, but it is complicated to set up. If you do not want to record your microphone into your mix or broadcast, you can *activate direct monitoring on your audio interface* without configuring latency compensation.

### Measuring Round Trip Latency

To configure Mixxx to compensate for input latency while using direct monitoring, first you must measure the round trip latency of your setup. The round trip latency is different from the size of the *Buffer Audio* configured in Mixxx. It is the amount of time it takes for audio to make a complete trip from your audio interface's input, through your computer, and back out the audio interface.

Mixxx cannot calculate the round trip latency because it depends on details of your audio interface's hardware, your operating system, your audio interface's driver, and other factors in your computer's hardware. The round trip latency can only be found by measuring it. To do this, use a physical cable to connect the audio interface's output to its input. Then, use a third party program to measure the round trip latency. These programs are recommended on each *OS*:

- **GNU/Linux:** `jack_iodelay`
- **Windows:** RTL Utility
- **macOS:** Audacity

You must use the same sample rate and audio buffer size in the measurement program as you do in Mixxx for the measurement to be accurate. If you decide to change the sample rate or buffer size you use with Mixxx, you will need to remeasure your round trip latency to have your microphone inputs aligned in your recorded and broadcasted mixes.

**Avvertimento:** Make sure direct monitoring is *not activated on your audio interface* while you are measuring the round trip latency or you will not get an accurate measurement.

### Configuring Latency Compensation

1. Before opening Mixxx, *measure the round trip latency*.
2. Open Mixxx.
3. Open *Preferences* ▶ *Sound Hardware*.
4. Click the *Input* tab.
5. Select the audio interface input(s) for the *Microphone 1-4* inputs. Select a single mono channel for each Microphone input unless you are using stereo microphones.
6. For the *Microphone Monitor Mode* option, select *Direct monitor (recording and broadcasting only)*.
7. Enter the measured round trip latency in milliseconds for the *Microphone Latency Compensation* option.
8. Click the *Apply* button.
9. Click the *OK* button.
10. *Activate direct monitoring on your audio interface*.

11. Click the *Mics* button in the main Mixxx window to show the microphone controls.
12. Click the *Talk* button when you are using the microphone.
13. Adjust the microphone volume with the input gain knob on your audio interface. Do not adjust the microphone gain in Mixxx. If you do, the relative volume of the mics and music will be different in your recorded and broadcasted mixes compared to what you hear out of your audio interface.

Mixxx will not record or broadcast your microphone if the *Talk* button is not active. However, you will still hear the microphone in your main output because the microphone is mixed by your audio interface, not Mixxx. You may leave the *Talk* button on to ensure you do not forget it, but this will record and broadcast background noise when you are not actively using the microphone. If your microphone has an on/off switch on it, you may leave the *Talk* button enabled in Mixxx and use the switch on the microphone to avoid adding background noise to your mix. Alternatively, you can adjust the input gain on your audio interface throughout your mix.

### 9.2.3 Activating Direct Monitoring And Loopback On The Audio Interface

General tips for activating direct monitoring and loopback are described below. However, every audio interface is different, so refer to the audio interface manual from the manufacturer for more details.

On stand-alone audio interfaces, there is often a knob on the device that controls direct monitoring. This knob crossfades the audio interface's output between the signal from the computer and the directly monitored inputs. If your audio interface has a knob like this, set the knob to the center. Alternatively, some audio interfaces have a switch to toggle direct monitoring instead of a knob.

To hear mono microphone inputs on both sides of the stereo output with direct monitoring, you typically need to toggle a switch on the device.

If the audio interface supports *Loopback Input*, that may be activated by a switch on the device.

Audio interfaces with lots of inputs and outputs often have a control panel program provided by the manufacturer that is installed automatically with the driver. This may be used instead of knobs and switches on the hardware to control direct monitoring, loopback, stereo/mono switches, and other audio interface features. On GNU/Linux, you might be able to access these controls with **alsamixer**.

Refer to the section below for details about *DJ Controllers With Microphone Inputs*.

## 9.3 Hardware Mixers

Mixxx can be used with a microphone plugged into an external hardware mixer. This does not have the problem with latency that happens with *Software Monitoring*. However, it is generally recommended to use an audio interface that supports *Direct Monitoring* and a *Loopback Input* instead of an external mixer. If you are using *Controllo Vinile* and a microphone, you may need an external mixer.

Mixxx can send each deck to separate stereo channels on an external mixer by using the *Deck 1-4* outputs. This requires an audio interface with at least 4 output channels (2 stereo pairs). Audio interfaces built into computers only have one stereo output and they do not have high sound quality. Thus, another audio interface is recommended. Audio interfaces with at least 4 output channels typically have microphone inputs and support *Direct Monitoring*, so there is no need for the external mixer.

However, audio interfaces with phono preamplifiers for *Controllo Vinile* do not have microphone inputs. If you want to use vinyl control with a microphone, it is recommended to plug the microphone into a DJ mixer.

**Avvertimento:** Some mixers that are not designed for DJing have a built-in USB audio interface. However, the audio interfaces in these mixers typically send only 2 channels (one stereo pair) to the mixer, so they are not recommended.



### 9.3.1 Recording And Broadcasting With An External Hardware Mixer

To record or broadcast with an external hardware mixer, the output of the mixer needs to be connected to the input of an audio interface. Most DJ mixers have an extra output for this which may be labeled «record», «session», «auxiliary», or «booth». Some audio interfaces for vinyl control have enough input channels to receive the output of the mixer and timecode from two turntables. If yours does not, you may use the input of the audio interface built into your computer, but these do not have high sound quality.

Alternatively, some DJ mixers have a built-in USB audio interface. These have inputs with phono preamplifiers for vinyl control and usually can send the record output back to the computer without a separate audio interface. Many (but not all) of these mixers are digital mixers, so they can send signals back and forth to Mixxx without converting them to analog. This results in higher sound quality for your recorded and broadcasted mixes compared to using a separate audio interface with an external mixer.

To configure Mixxx for using a hardware mixer for recording and/or broadcasting:

1. Open *Preferences* ▶ *Sound Hardware*.
2. In the *Output* tab, select the audio interface for the *Deck 1-2* outputs (and *Deck 3-4* outputs if your audio interface and mixer support 4 decks).
3. Click the *Input* tab.
4. For the *Record/Broadcast* input, select the audio interface connected to the mixer's output. For mixers with a built-in USB audio interface, refer to the mixer manufacturer's manual to find which channels of the mixer's audio interface send the record output.
5. If you are using vinyl control, select the audio interface connected to the turntables for the *Vinyl Control 1-4* inputs.
6. Click the *Apply* button.
7. Click the *OK* button.

Do not configure anything for the *Microphone 1-4* inputs when using an external mixer. The microphone controls in Mixxx will not affect your microphones because the microphone is mixed by the external mixer.

DJ mixers typically do not supply phantom power required for condenser microphones. Stand-alone audio interfaces typically do supply phantom power.

## 9.4 DJ Controllers With Microphone Inputs

DJ controllers with microphone inputs typically mix the microphone input with the master output without sending it to the computer. This does not have the problem with latency that happens with *Software Monitoring*. However, many cheap DJ controllers do not digitize the signal to make it available to the computer. Refer to the controller's page on the [Mixxx wiki](#) or the manual from the controller manufacturer for details about your particular controller.

If the controller does not digitize the microphone input, you cannot use Mixxx's microphone input to record or broadcast with the microphone using Mixxx's *Microphone 1-4* inputs. It is still possible to record and broadcast the microphone by connecting the booth output of the controller to an audio interface input and configuring this for Mixxx's *Record/Broadcast* input. If the controller does not have a booth output, a Y splitter cable can be used on each side of the stereo main output to connect the main output to both the speakers and to another audio interface's input.

DJ controllers typically do not supply phantom power required for condenser microphones. Stand-alone audio interfaces typically do supply phantom power.

## 9.5 Microphone Ducking

Microphone ducking is a technique to improve the audibility of speech by reducing the volume of background music while a voice signal is recorded by the microphone and allows listeners to hear the voice more clearly and consistently. While using Mixxx with a microphone, you might want the music to automatically fade into the background each time you speak, or you might prefer lowering the volume of the music to a specific level. Microphone ducking helps you achieve this. The music will “duck” out of the way of the microphone audio.



Figure1: The microphone ducking controls

The *Strength* knob adjusts the microphone talkover ducking strength and its behaviour depends on any of the Microphone talkover modes described below. Clicking on the *Auto* button will switch it to any of three modes:

- *Off*: When you speak through the microphone, the music volume does not reduce.
- *Auto*: When you speak through the microphone, the music volume will be reduced when Mixxx detects your voice. You can adjust the amount by which the volume is automatically reduced with the Strength knob.
- *Manual*: In this mode, the music will play at the volume set by the Strength knob whenever the microphone Talk button is active, regardless of the volume coming through the microphone input. When you speak through your microphone, set the volume to which the music should reduce by turning the Strength knob to a level that suits you. When you disable Talk mode, the music will return to the regular volume

---

**Suggerimento:** To set the Ducking volume correctly, you can use manual mode to adjust the knob to your taste and then set to auto when happy.

---

---

## Live Broadcasting - Start your own Internet radio

---

Live Broadcasting in Mixxx allow you to stream your mix over the Internet to listeners around the world.

### Vedi anche:

The *Using Microphones* chapter has detailed instructions for including input from microphones in your broadcasted mixes.

## 10.1 Streaming Servers

**Remote streaming server** Mixxx allows you to feed your audio stream directly to *Shoutcast* and *Icecast* streaming servers. Depending on the number of listeners, streaming audio requires a significant amount of bandwidth. Streaming servers provide the required bandwidth and broadcast the stream to your listeners. A popular free streaming service is *Caster.fm*. A review of several free and paid stream hosts is available at [broadcastingworld.net](http://broadcastingworld.net).

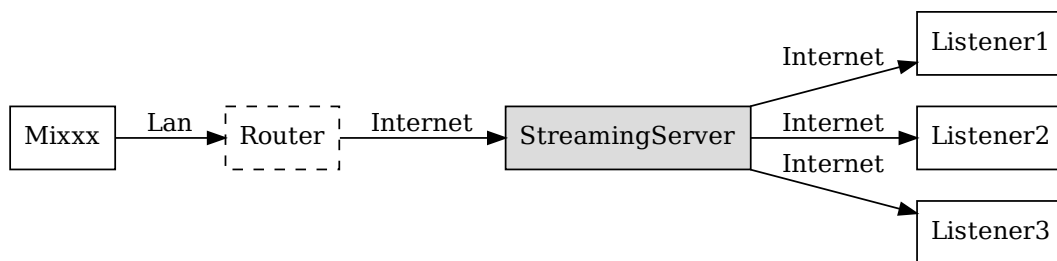

Figure 1: Mixxx as client-side streaming source broadcasting to an remote streaming server

**Local streaming server** For experienced users, it may be interesting to set up your own local streaming server. This turns your personal computer into a radio station and listeners connect directly to your server. Mixxx as a streaming

source does not need to run on the same computer as your streaming server. However, professional stations often run the streaming source on the same computer as the streaming server for stability and reliability reasons. Keep in mind that if you want to stream audio to a significant number of listeners, you'll need enough bandwidth. Read the [Shoutcast documentation](#) or [Icecast documentation](#) for server setup instructions.

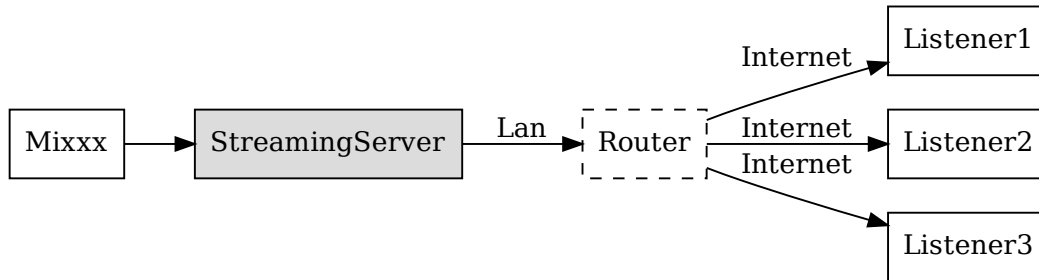

Figure2: Mixxx as client-side streaming source broadcasting to an local streaming server

## 10.2 Configuring Mixxx

Start by supplying Mixxx with all information needed to establish a connection to the streaming server:

- Open *Preferences* ▶ *Live Broadcasting*.
- Insert the settings following the descriptions in the *Mixxx preferences - Setting up live broadcasting*
- Click *OK*
- Go to *Options* ▶ *Enable Live Broadcasting* or use the *Application shortcuts* to start broadcasting.

### 10.2.1 Server Connection

- **Type:** Select the type of streaming server you want to connect with. *Shoutcast 1*, *Icecast 1*, and *Icecast 2* servers are supported.

Mixxx works with Shoutcast 2 using the Shoutcast 1 protocol if you provide a stream name in *Preferences* ▶ *Live Broadcasting* ▶ *Stream Settings*. If you don't provide a stream name, Shoutcast 2 rejects the connection (where Shoutcast 1 would accept this case).

- **Host:** You can enter the host as either a host name or an IP address.
- **Login:** As provided by your streaming server provider. Without this, you will not connect successfully to the server. The default login for *Icecast* is `source` while the default login for Shoutcast is `admin`.
- **Mount:** A mount point is a unique name identifying a particular stream. For *Shoutcast* it is not necessary to specify a mount point. The setting must not be blank if you are using *Icecast*. Try the default `/mount` or `/live`. If you haven't been given a specific mount point you can usually make one up. It always begins with a `/` (slash) followed by a text without any special characters in it.
- **Port:** As provided by your streaming server provider. Most servers use the default port 8000.

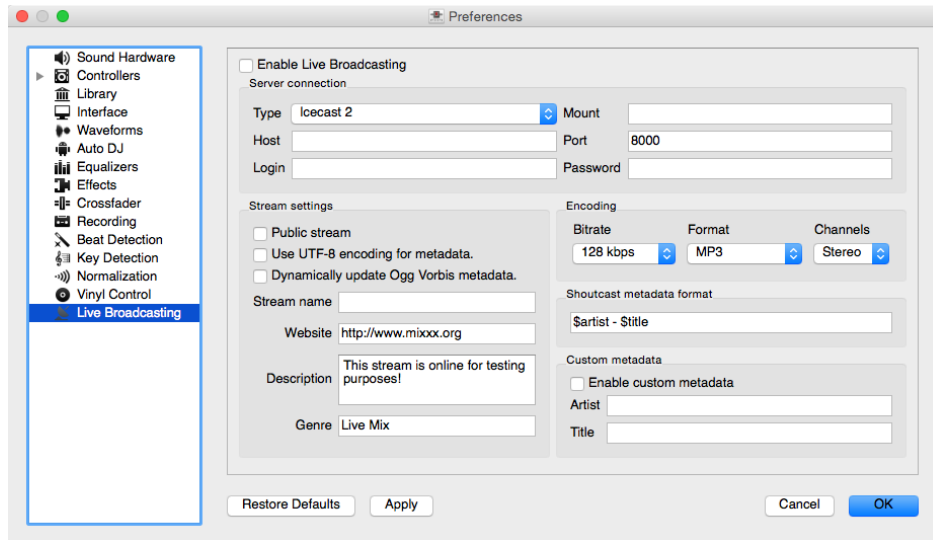

Figure3: Mixxx preferences - Setting up live broadcasting

- **Password:** As provided by your streaming server provider, unless you run your own radio server. It is required to establish the connection to the server and to start the broadcast.

**Avvertimento:** Do not enter a *URL* as the host! `http://example.com:8000` does not work. Use `example.com` in the *Host* field and `8000` in the *Port* field instead.

## 10.2.2 Stream Settings

- **Public stream:** If enabled, this option adds your radio station to the Shoutcast/Icecast directory.
- **Enable UTF-8 metadata:** If enabled, this option fixes broken accented and foreign language symbols in *metadata*, assuming the streaming provider has configured the server to support UTF-8 metadata.
- **Dynamically update Ogg Vorbis metadata:** Due to flaws in some streaming clients, updating Ogg Vorbis metadata dynamically can cause listener glitches and disconnections. Check this box to update the metadata anyway. Some players that listeners can use have bugs that can cause audio glitches or disconnections when the Ogg Vorbis metadata is updated dynamically. If this is not a problem, you can enable this checkbox.
- **Stream name:** So, what's the name of your show?
- **Website:** The website you would like your listeners to visit.
- **Description:** Enter your DJ name and a short tagline.
- **Genre:** List the main genres you play. This attracts search hits on stream directories. Genre must not be blank.

## 10.2.3 Encoding

- **Bitrate:** Selecting a *bitrate* of 128 or 160 *kbps* is common and provides sufficient quality to your listeners. Higher bitrates will use a larger chunk in your Internet connection bandwidth to stream and for your listeners to receive the stream.
- **Format:** Mixxx supports streaming to Icecast servers either in *MP3* or *Ogg Vorbis* format, streaming to Shoutcast servers is supported in *MP3* format.

## 10.2.4 Metadata

### Shoutcast metadata format

This allows to set custom metadata formats for the Shoutcast title field. Previously only `artist - title` was allowed. For example if you were broadcasting as part of a station, you could add the station's name or the presenter's name in the title: `MyStation | $artist - $title`. Or if you were doing a live mix with several artists, you could have: `Live mix by MyName - currently playing: $artist`. Or even if you wanted a very unusual format: `Hey, I like $artist, here is $title by $artist`.

The changes **do not** affect the case for the combination of OGG/Icecast2.

### Custom metadata

By default, Mixxx broadcasts artist and title information of the files that you play to your listeners. You can disable this feature and use your own custom metadata.

- **Enable custom metadata:** Toggles custom metadata on and off.
- **Artist:** Insert your custom artist metadata here, your DJ name for example.
- **Title:** Insert your custom title metadata here.

## 10.2.5 Icecast vs. Shoutcast

Both essentially serve the same purpose. An Icecast server can stream either *MP3* or *Ogg Vorbis*. However, although Ogg is more efficient and effective (you get higher-fidelity sound than MP3 at lower data rates) not all players can play Ogg streams. As a result MP3 is probably a safe choice unless you know your listeners can hear an Ogg stream successfully.

## 10.2.6 Broadcast directories

Generally your streaming server host adds your radio station to the Shoutcast/Icecast directory, if you enable the *Public Stream* option in *Preferences* ▶ *Live Broadcasting* ▶ *Stream Settings*.

- **Shoutcast radio directory:** [www.shoutcast.com](http://www.shoutcast.com)
- **Icecast radio directory:** [dir.xiph.org](http://dir.xiph.org)

Often streaming hosts will run their own directories. Check your host's FAQ to find out. If you want to promote your streaming radio station even more, register at services like [streamfinder.com](http://streamfinder.com). An overview of different internet radio directories is available at [shoutcheap.com](http://shoutcheap.com)

## 10.3 Troubleshooting

- If you have trouble connecting to your streaming server, check the configuration in the *Mixxx preferences - Setting up live broadcasting*.
- You may have selected the *Ogg Vorbis* format that is unsupported by Shoutcast servers.
- You may need to check your firewall settings. Both Icecast and Shoutcast use two ports. If you are streaming on a port (for example, port 8000) then you need to open up the next port (port 8001) as well.
- You may need to configure port forwarding if you are behind a router or your router will block requests to your streaming port (for example, port 8000)

Mixxx has a powerful sound effects system. Understanding how it works can open you up to a wide variety of mixing techniques.

### 11.1 Effect Units

Mixxx has 4 effect units. By default, only 2 of them are shown. The other 2 effect units can be shown by toggling the setting in the skin settings menu.

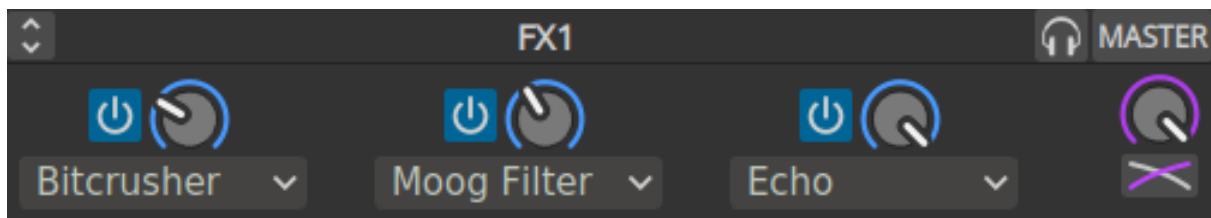

Figure1: An effect unit

Each effect unit can load up to 3 effects in a chain. These effects are processed one after the other in series. You will hear different sounds depending on the order of effects within the chain. Each effect in the chain has its own button to toggle it on and off.

#### Effect units can process sound from:

- decks
- microphones
- auxiliary inputs
- the master mix
- the *PFL* (headphone) mix



- left/middle/right crossfader buses

The buttons to route effect units to decks, microphones, and auxiliary inputs are located in the deck, microphone, and auxiliary sections of the skin. The buttons for routing other inputs to effect units are in different locations depending on the skin.

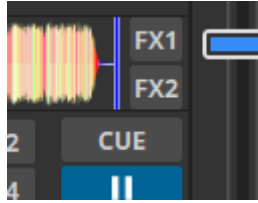

Figure2: The effect unit buttons located in the deck.

If a channel is assigned to multiple effect units, those effect units are chained together. This allows you to chain more than 3 effects at a time.

To route deck 1 to effect unit 1, click the *FX1* button on deck 1 to turn it on. To route deck 2 to effect unit 2, click the *FX2* button on deck 2, and so on. It's also possible to route a single deck to multiple effect units, or multiple decks to a single effect unit.

The mix knob adjusts the mix between the dry signal (input to the unit) and the wet signal (output of the last effect in the unit). It changes the level of all 3 effects in the unit together. Refer to the [Effect Unit Mix Modes](#) section below for details.

Effects are processed after the deck faders and crossfader. This allows effects like Echo and Reverb to continue outputting sound after their input has been cut off by lowering the fader. Unlike other DJ software and hardware, effects can also be heard in headphones even though they are processed after the faders for the master output. Refer to the [Effects In Headphones](#) section below for details.

Note that equalizer and filter effects create a phase shift. If the mix knob is anywhere in the middle between dry and wet and any of these effects are enabled in the unit, there will be comb filtering which is probably not desired. For more background information, read [Equalizers and Phase Shift](#).

## 11.2 Effect Parameters & Metaknobs

Every effect within an *Effect Unit* has its own set of parameters. By default, these are hidden. Instead, there is a single knob called a «metaknob» for each effect which is linked to the different parameters. The metaknob allows you to easily control the effects in a unit without having to manipulate every parameter individually.

If you want more detailed control of effects, press the expansion button on the effect unit to reveal the effect parameters:

You can customize how the metaknob is linked to the parameters by clicking the buttons below the parameter knobs. The button under the parameter name controls the metaknob link mode:

- Inactive: parameter not linked
- Active: parameter moves with metaknob
- Left side active: parameter moves with left half of metaknob turn
- Right side active: parameter moves with right half of metaknob turn
- Left and right side active: parameter moves across range with half of metaknob turn and back with the other half

The button below the metaknob link button inverts the parameter's relationship to the metaknob.

For information about specific effects and their parameters, hover your mouse over them to show the tooltip. If you do not see tooltips, check that you have them enabled for the skin in *Preferences* ▶ *Interface*.



Figure3: An effect unit with parameters showing

Effects (except for Reverb) that have a length of time as a parameter are synchronized to the tempo of decks.

### 11.3 Effect Unit Mix Modes

The effect unit mix knob controls the level of all 3 effects in the unit together. It can be toggled between two different modes with the mix mode button adjacent to it.

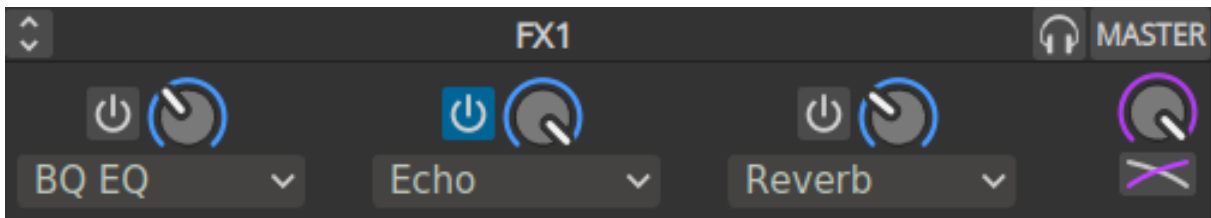

Figure4: An effect unit in Dry/Wet mode

In the default Dry/Wet mode, the mix knob crossfades between the dry signal (input to the first effect in the unit) and the wet signal (output of the last effect in the unit). When the knob is fully left, no sound will be heard from the effect unit. When the knob is fully right, only the output of the effect unit will be heard without any of the dry input signal.

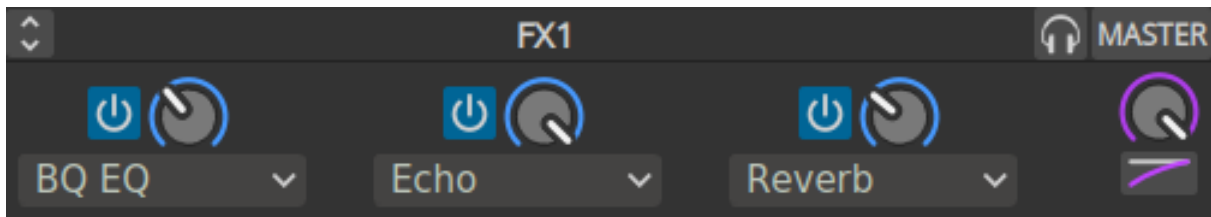

Figure5: An effect unit in Dry+Wet mode

In Dry+Wet mode, the dry signal is always at full volume. The mix knob controls how much of the wet signal is added to the dry signal. A useful example for Dry+Wet mode is loading a filter or equalizer effect before the Echo effect. With this setup, the filter or equalizer can remove bass frequencies from the echoed signal without removing them from the unechoed signal. If the effect unit is switched to Dry/Wet mode with the same effects in the same order, the bass frequencies will be taken out of the echoed signal, but they will also be removed from the unechoed signal.

## 11.4 Effects In Headphones

To preview how a track will sound with effects before you mix in the track, simply assign the deck to an effect unit and enable the headphone button for the deck. Note that this will increase CPU compared to assigning an effect unit to a deck without the headphone button enabled. This is because effects are processed in parallel for the headphone output (prefader) and master output (postfader).

Effects can also be previewed in headphones on decks that are playing to the audience, but this requires a few more steps:

1. Disable the effect unit for the deck
2. Enable the headphone button for the deck
3. Enable the headphone button for the effect unit
4. Enable effects and adjust their metaknobs and parameters for how you want the effects to sound.
5. When you are ready to mix in the effect, turn the mix knob fully left (dry)
6. Enable the effect unit for the deck
7. Turn the mix knob right so the effects are heard in the master output
8. Disable the headphone button for the effect unit so you do not forget to turn it off later

## 11.5 Controller Effects Mapping

This section describes how to use the standard Mixxx mapping for effects sections on controllers with the typical layout of 4 knobs (or 3 knobs + 1 encoder) and 4 buttons for effects. It allows you to switch between controlling all 3 effects of a chain or controlling each parameter of one effect.

By default, 3 knobs are used for controlling effect metaknobs and the buttons under them toggle each effect on/off. To temporarily toggle an effect on/off, press and hold an effect enable button. The 4th knob is used for the mix (dry/wet) knob of the whole chain. On controllers designed for Serato, the *Beats* encoder is used as the mix knob.

The button next to the mix knob is used for focusing effects. On controllers designed for Serato, this button is labeled *Tap*. While holding this button pressed, the enable buttons for each effect switch to choosing which effect is focused. When an effect is focused:

- the knobs switch to controlling the first 3 parameters of that effect instead of the metaknobs of each effect in the chain;
- the buttons switch to controlling the first 3 button parameters of the effect; and

The LED of the focus button indicates whether any effect is focused. When its LED is on, you can hold the button down to see which effect is focused without having to look at the computer screen. To unfocus the effect, you can short press the focus button. The focused effect is remembered, so when you short press the focus button again, the previously focused effect will be refocused (it is not remembered when you shut down Mixxx though).

Alternatively, if you want to keep all the parameters showing on screen, you can press and hold the focus button, then press the button of the focused effect to unfocus it. Showing all the parameters without having an effect focused is helpful for experimenting with different ways of linking parameters to the metaknob.

When the focus button is pressed with shift, it toggles the Effect Unit between controlling different *Effect Units* in Mixxx. Typically this is used to toggle between *Effect Units* 1 & 3 or 2 & 4, like deck toggle buttons.

To load different effects, hold shift and turn the knob for an effect.

To load chain presets 1-4, press the buttons with shift (new in Mixxx 2.4).

Mixxx è stato progettato per essere facile da imparare sia per DJ principianti che esperti.

Questa parte del manuale fornisce indicazioni per utilizzare le funzionalità di Mixxx per creare i propri mix.

## 12.1 Impostazione dei Livelli Propriamente (Guadagno Staging)



L'impostazione dei livelli correttamente, noto anche come stadio di guadagno, è essenziale per ottenere la migliore qualità audio dall'apparecchiatura in uso. A ogni collegamento della vostra catena di segnali, dai guadagni del canale di Mixxx all'amplificatore di potenza, il livello dovrebbe essere ben al di sopra del rumore di base, ma inferiore al livello massimo prima dei clip di segnale. Il *misuratori di livello* deve essere per lo più intorno alla cima della loro regione verde. Il misuratore di livello mostrato a sinistra mostra dove i misuratori di livello di Mixxx dovrebbero essere mediati nelle parti più alte di brani. Il livello medio non dovrebbe essere nella regione gialla. Utilizzare la regione gialla per lasciare la testata o il livello disponibile sopra la media prima dei clip del segnale. Le parti più rumorose della musica (i transitori) dovrebbero brevemente entrare nella regione gialla.

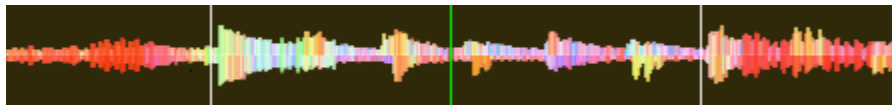

Figure1: Una forma d'onda ad un buon livello. Si noti che le forme d'onda di esempio in questa sezione sono state effettuate regolando il guadagno visivo del display della forma d'onda in Mixxx per illustrare i concetti. La regolazione del guadagno visivo della visualizzazione della forma d'onda non cambia il livello dell'audio.

Se un misuratore di livello si trova nella sua regione rossa, il segnale si riduce e il guadagno deve essere abbassato. Alcune apparecchiature non hanno un misuratore di livello e hanno solo un LED che si accende quando il segnale si blocca. Ritaglio significa che i picchi della forma d'onda sono appiattiti perché l'apparecchiatura ha raggiunto il livello massimo a cui può amplificare il segnale. Ciò distorce il suono in modo sgradevole e può danneggiare l'apparecchiatura guidandola con più energia di quanto non sia progettata per essere gestita. Aumentando il guadagno oltre il punto in cui inizia il ritaglio (più avanti nel rosso su un metro) si distorce maggiormente il segnale. Se si desidera aumentare il volume quando ogni parte della catena del segnale è al massimo senza clipping, utilizzare più altoparlanti o utilizzare altoparlanti più sensibili e convertire l'energia elettrica in energia acustica in modo più efficiente.

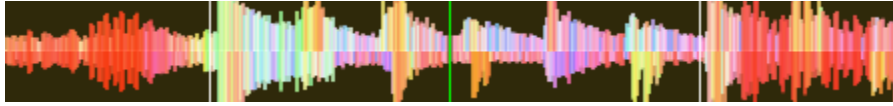

Figure2: Una forma d'onda di ritaglio



D'altro canto, il segnale non dovrebbe essere troppo basso. Questo perché ogni dispositivo audio genera un po' di rumore a un livello indicato come piano del rumore. Inoltre, i segnali analogici assorbono il rumore mentre viaggiano lungo i fili. Il segnale misurato dal misuratore a sinistra è relativamente vicino al rumore. Quando un dispositivo è alzato, il rumore di fondo non sale; solo il segnale. Tuttavia, ogni volta che il segnale viene amplificato dal guadagno di un'altra apparecchiatura, vengono amplificati sia il rumore che il segnale dei precedenti dispositivi nella catena del segnale. Ad esempio, se la tua scheda audio è abbassata e alzi il guadagno del mixer per compensare, il rapporto segnale / rumore (SNR) dell'uscita della scheda audio sarà basso e il guadagno del mixer amplifica il segnale e rumore dalla scheda audio, più il rumore raccolto lungo il filo. Il risultato finale avrà più rumore rispetto a quando l'uscita della scheda audio è stata alzata prima che il segnale raggiungesse il mixer e il guadagno del mixer non dovesse essere aumentato.

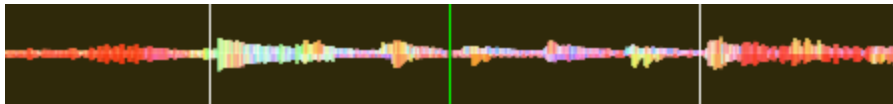

Figure3: Una forma d'onda troppo vicina al rumore

---

**Nota:** To adjust the output volume of a sound system while maintaining a high signal-to-noise ratio, the gain should be adjusted as close to the speakers as possible. Refer to the *Gain Knob* section for details.

---

## 12.2 Beatmatching e missaggio

*Beatmatching* is the process of adjusting the playback rate of a track so that it matches the tempo of another track. Beatmatching also involves adjusting the *phase* of the beats in a track so that they are aligned with the beats in the other track. Matching the *tempo* and aligning the beats are the two things a DJ must do to beatmatch.

Mixxx può abbinare il tempo e allineare i battiti per voi, ma questo richiede un valore BPM accuratamente rilevato e una griglia battuta corretta per entrambe le tracce. Per abilitare questa funzione, toccare il tasto *SYNC*. Per eseguire manualmente il beatmatch, il tempo delle due tracce deve essere sincronizzato regolando i cursori della velocità di riproduzione. È possibile regolare la fase dei battiti facendo clic con il tasto destro e trascinando su entrambi i display della forma d'onda per accelerare temporaneamente o rallentare una delle tracce fino a quando i battiti sono allineati. I pulsanti temporanei di pitch bend possono anche essere utilizzati per regolare momentaneamente la velocità di riproduzione, consentendo di «mischiare» i battiti di una traccia in avanti o all'indietro, in modo che possano essere allineati con un'altra traccia. Vedi il capitolo *Sync and Rate Controls*.

Due tracce sono beatmatched una volta che i loro tempi sono abbinati e i loro ritmi sono allineati. Un beatmatch «perfetto» è quasi impossibile - ci sarà sempre una piccola differenza nei tassi di riproduzione. Un DJ appassionato terrà le orecchie aperte e ascolterà i battiti che si allontanano dall'allineamento. Questo ha un distinto suono di «contrabbasso» che è spesso

preceduto dal calcio che si indebolisce in intensità man mano che i due calci si spostano fuori fase. Quando ciò accade, i battiti possono essere riallineati semplicemente toccando uno dei pulsanti temporanei del pitch bend alcune volte nella direzione appropriata.

## 12.3 Master Sync

*Master Sync* is an intelligent assistant that allows you to leave the beatmatching to Mixxx so you can focus on track selection, effects manipulation, looping, 4 deck mixing, and other advanced DJing techniques.

To activate Master Sync on a deck, push and hold (or click and hold) the *SYNC* button. You'll know Master Sync is on because the sync button will remain lit. Changing the rate of any deck that has Sync lit will change the rates of all other decks that also have the Sync button lit. There is no need to set specific decks to be a master or followers. You can play, stop, eject, load, and queue any track with master sync and it won't interrupt the playback of the other decks. However, changing the rate of a stopped deck will change the rate of playing decks.

Master Sync noterà anche se una delle tue tracce è il doppio del BPM di un'altra traccia e le abbina correttamente. Quindi, se vuoi mixare una traccia drum & bass da 140 BPM con una traccia dubstep da 70 bpm, Master Sync si assicurerà che siano allineati correttamente.

---

**Suggerimento:** Solitamente, Master Sync si limita ad assicurarsi che i cursori rate siano impostati correttamente. Se vuoi anche assicurarti che i tuoi battiti siano perfettamente sincronizzati, attiva il pulsante *QUANTIZE*. Quando attivato, Quantize assicurerà che i battiti siano perfettamente allineati.

---

## 12.4 Mixaggio armonico

Harmonic mixing is a technique to mix songs with matching melodies and harmonies. To learn more about harmonic mixing you might want to check out [the mixshare archive](#).

Mixxx has two features to help you with harmonic mixing. The first is a *key lock*. When it is active changing the speed of a track won't affect the key. To enable *key lock*, click the *key lock* button in the *Deck Options Button Grid*. The second is that Mixxx can automatically detect the key of a track and will display it in the library and the decks. The notation which is used to display a key can be changed in *Key Detection Preferences*.

## 12.5 Registrare il tuo mix

With the integrated recording feature you can record your mix as an audio file and listen to it later, distribute it as a *Podcast* or burn it to CD.

By default, Mixxx records the Master output. Alternatively, Mixxx can record the output of an external mixer if you have an audio interface configured for the *Record/Broadcast* input in *Preferences ▶ Sound Hardware*. Refer to *Recording And Broadcasting With An External Hardware Mixer* for details.

Mixxx can record your mix in various audio formats and quality settings. You can split your recordings, generate *cue files*, choose a custom recording directory and even set your own *metadata*. By default, Mixxx saves your recordings as lossless *WAV* files to a *Mixxx/Recordings* sub-folder in the Mixxx music directory. Before you start recording, we recommend that you adjust the settings in *Preferences ▶ Recording*.

Se si fa clic sull'icona *Registrazioni* nella barra laterale della libreria Mixxx, la tabella della traccia a destra mostra il contenuto della directory delle registrazioni. Le nuove registrazioni vengono salvate automaticamente in questa directory e anche nei file CUE se si sceglie di crearli nelle preferenze.

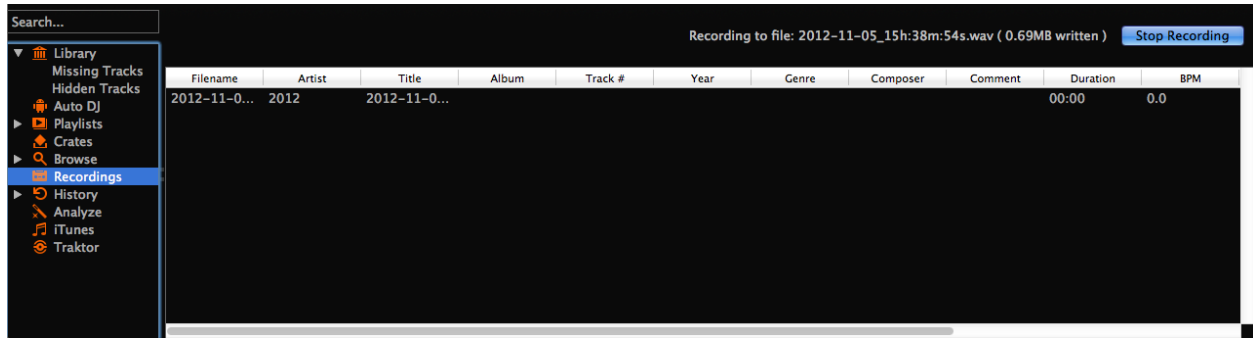

Figure4: Libreria Mixxx - Vista registrazioni

**Suggerimento:** Registrando i tuoi mix e ascoltandoli in seguito per criticare te stesso è un ottimo strumento per migliorare le tue abilità di DJing. Anche l'invio dei tuoi mix ad altri DJ per un feedback può essere utile.

### 12.5.1 Registra il tuo mix su disco

Click on the recording icon on top of the application window to start, and stop the recording session. The duration of the running recording is displayed next to the icon.

**Nota:** The recording widget might not be available in some skins.

Alternatively:

- Fare clic sull'icona *Registrazioni* nella barra laterale per passare alla vista *Registrazioni*
- Fare clic sul pulsante *Avvia registrazione* o fare clic su *Opzioni* ▶ *Registra mix* nel menu in cima alla finestra dell'applicazione Mixxx.
- The display above the track table shows how much data has already been recorded, as well as the duration of the recording.
- Esegui il tuo mix
- Fai clic sul pulsante *Interrompi registrazione* per interrompere la registrazione al termine del mix.

**Suggerimento:** You can instantly play your recording as a track in Mixxx. Simply drag-and-drop the track to a deck.

## 12.6 Intro and Outro Cues

Intro/Outro cues are used to mix in and out of tracks and they can also be *used with Auto DJ* to mix in and out at those points. Unlike *hotcues*, they do not mark only one point. The intro and outro are sections and each section is defined by two points.

Mixxx detects where the first and last sounds are when analyzing a track making it easy to stop playing silent parts at the beginning and at the end of the track. The analyzer places the intro start point at the first sound and the outro end point at the last sound. The first and last sounds are determined by the first time the signal rises above -60 dBFS and the last time it goes below -60 dBFS.

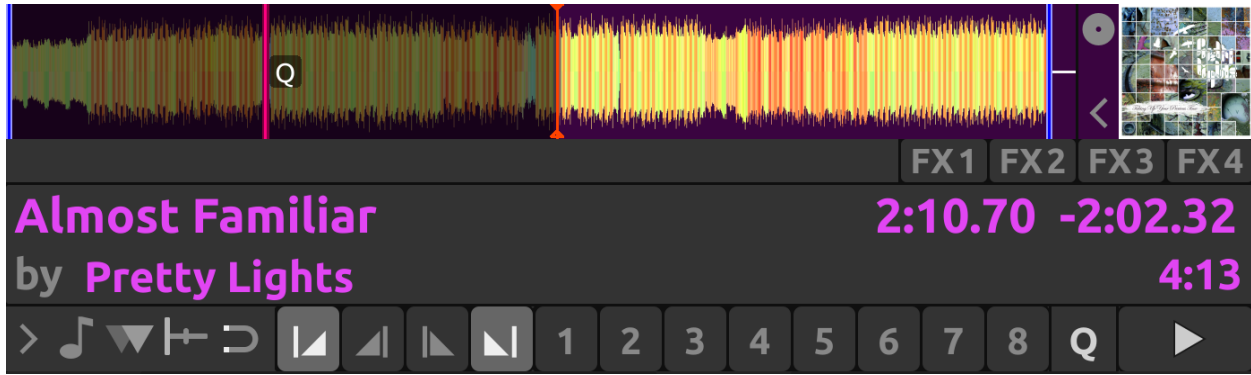

Figure5: Intro start and outro end cues placed at the first and last sound of a track respectively by the analyzer

You can decide where to place the intro end and the outro start points. Marking the whole intro and outro allows Mixxx to calculate how long each section is and show it on the overview waveform. This information can help you know when to press play on the next track. *Auto DJ can also use this information* to line up tracks and determine how long to crossfade.

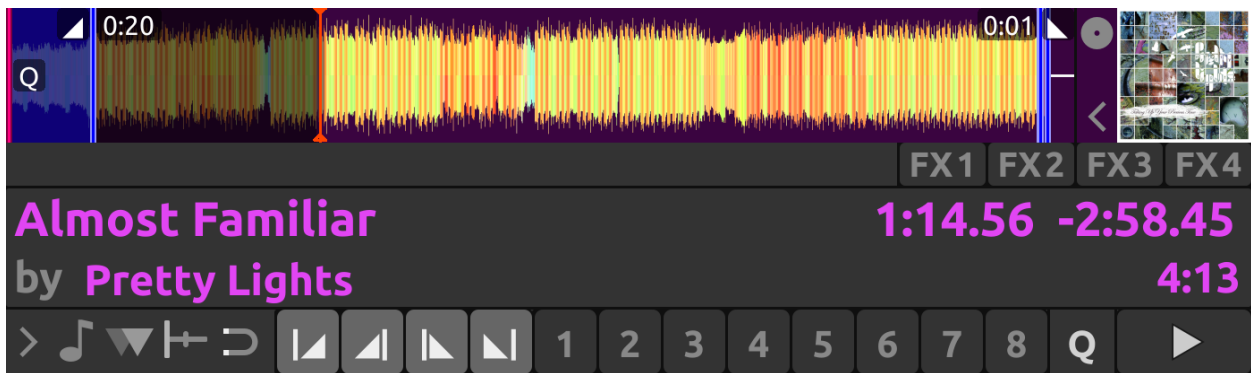

Figure6: Intro end and outro start markers placed on the track alongside the intro start and the outro end markers to make sections

### 12.6.1 Mixing With Intro & Outro Cues

You can line up the ends of the intro and outro so the energy of the new song picks up right as the old track ends.

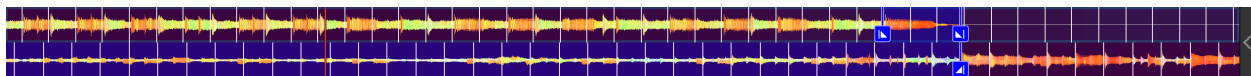
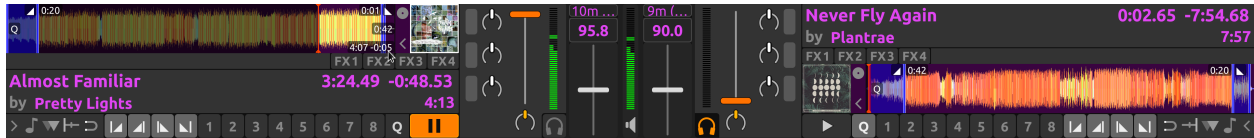

Figure7: Intro and outro end markers aligned showing on the waveform

If the intro and outro are short enough to fit on the waveform at the same time, you can simply watch the waveforms and press play when the markers align. Otherwise, you can watch the time remaining on the deck and hover your mouse cursor over the outro end line on the overview waveform. Mixxx will show you how much time is left until that point. When that time equals the length of the intro, press play to precisely line up the end of the intro. If you have changed the tempo of the track, the time remaining scales to show the real time remaining at the adjusted tempo.

Alternatively, you can line up the start of the intro & outro. In this case, watch the scrolling waveform when the outro start point is coming up on the old track. Then, press play on the new track when the old track reaches the outro start.





**Nota:** There are no rules on which method should be used. The method you decide to use is an artistic judgement based on the musical content of each track, what the vibe of the crowd is at that moment, and what you want to do with the mix.

If you do not have the intro end and outro start points marked when loading a track, you can find and mark these in headphones before you mix in the track. Then seek back to the intro start to get the track ready. If you don't have time to find the outro end point before mixing in the track, you can use the deck cloning feature to drag and drop to a new deck, then seek ahead on the new deck and listen in headphones to mark the outro start point. If you don't have time to do that either, you can right click on the overview waveform where you think the outro starts. Then look for how far that is from the end of the track to compare it to the length of the intro of the next track.

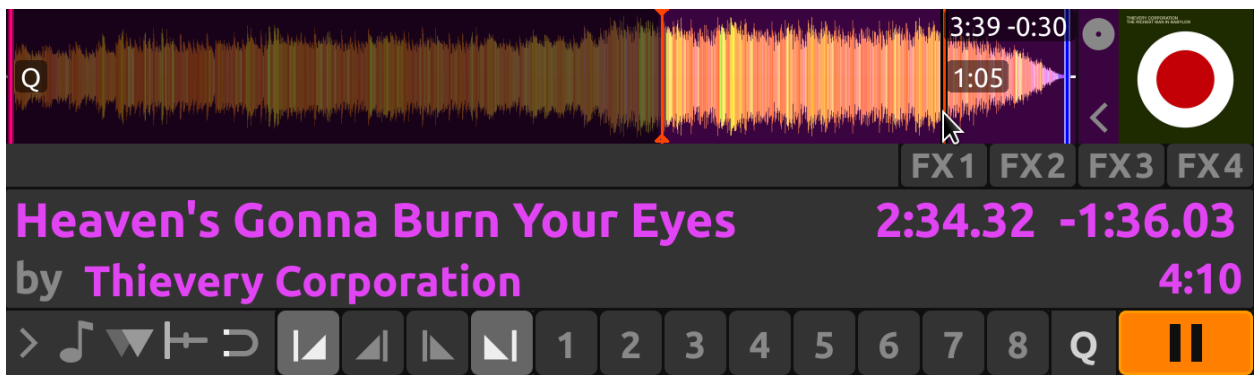

Figure8: Here the outro is approximately 30 seconds long. However, the analyzer placed the outro end point before the end of the track, so the outro is actually a little bit shorter than 30 seconds. Without marking the outro start point, you would have to do some math in your head to find exactly how long the outro is.

## 12.7 Auto DJ

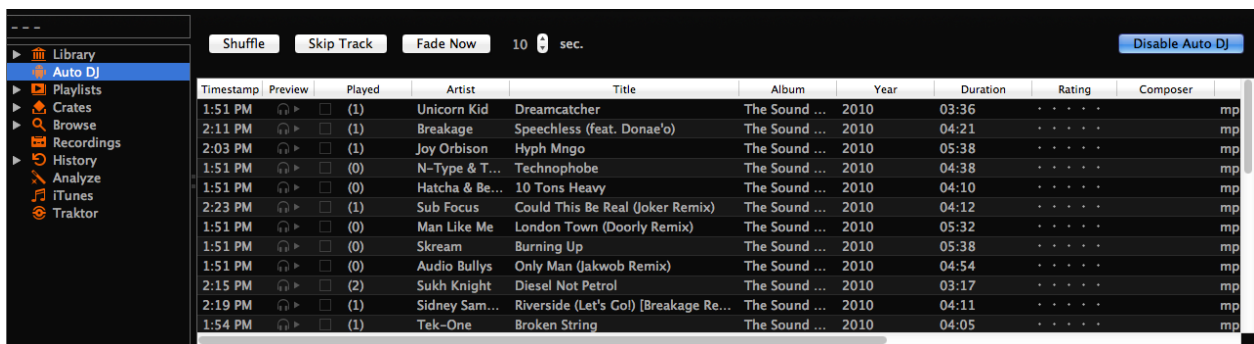

Figure9: Libreria Mixxx - Vista Auto DJ

Auto DJ ti consente di caricare automaticamente le tracce dalla playlist di Auto DJ quando la traccia corrente è quasi

finita e fa la dissolvenza incrociata in essa. Vedi *Auto DJ - Automate your mix*.

Auto DJ does not take into account the volume of each track, nor the frequency content, nor the rhythms, so it's not intended to be a replacement for a human DJ. However, it is good enough to give a human DJ a break without a major disruption to the mix.

### 12.7.1 Caricamento di tracce in Auto DJ

Per riprodurre automaticamente le tracce, devono prima essere caricate nella playlist Auto DJ. La playlist Auto DJ è vuota per impostazione predefinita.

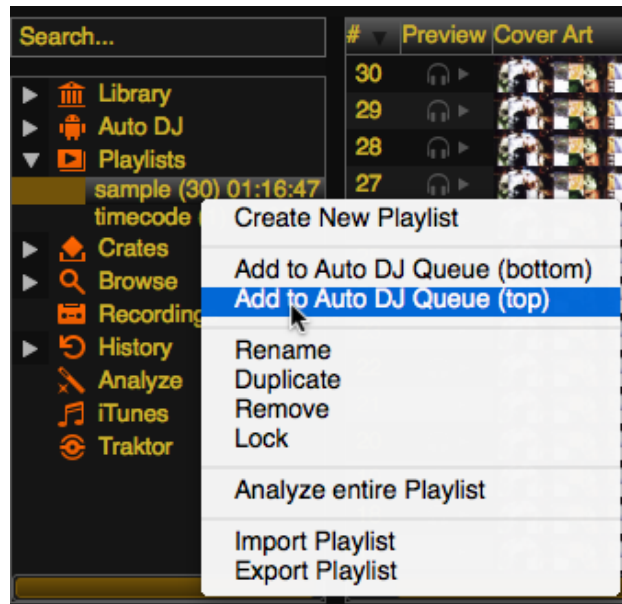

Figure10: Libreria Mixxx - Aggiunta di una playlist a Auto DJ

Esistono diversi modi per caricare le tracce nella playlist Auto DJ:

- Seleziona una o più tracce dalla libreria, una playlist normale o una cassa e trascinali sull'icona Auto DJ sulla sinistra.
- Seleziona una playlist o una cassa normale, fai clic con il pulsante destro del mouse e seleziona *Aggiungi a Auto DJ* dal menu del mouse. Questo aggiunge tutte le tracce ad Auto DJ.
- Nella vista Auto DJ della libreria, trascina le tracce da file manager esterni all'icona Auto DJ nella barra laterale o alla tabella delle tracce Auto DJ sulla destra.

### 12.7.2 Automatically adding tracks from crates

Instead of inserting the contents of the crates directly into the Auto DJ playlist, *Auto DJ crates* are associated crates that become a source of random track selections.

- **Add a crate to the Auto DJ track sources:** Expand the *Auto DJ* item in the sidebar, and right-click on the *Crates* sub-item. Select one of the existing crates from the list. This makes the content of the crate available for random selection into the *Auto DJ* queue for automatic mixing. The name of the crate is now listed as sub-item below.

If you do not have any crates available for selection in the list, go and create a crate first and add some tracks, see *Crates - Organizing tracks into collections*.

- **Manually add tracks from track sources to Auto DJ:** Click the *Auto DJ* item in the sidebar and switch to the Auto DJ view of the library. Click the *Add random* button to add one track at the time from Auto DJ track sources to the bottom of the Auto DJ playlist.

---

**Nota:** If you did not set any crates as an Auto DJ track source, clicking the *Add Random* button will add a randomly selected track from the whole library instead.

---

- **Automatically add tracks from track sources to Auto DJ:** Mixxx can randomly add tracks to the Auto DJ playlist from track sources as soon as a specified minimum number of tracks remain. Select *Preferences* ▶ *Auto DJ* ▶ *Enable random track addition to queue* ▶ *On*. Set *Minimum allowed tracks before addition* to change the minimum number of tracks after which random tracks may be added.

---

**Nota:** If you did not set any crates as an Auto DJ track source, tracks are selected from the whole library instead.

---

- **Remove a crate from the Auto DJ track sources:** Expand the *Auto DJ* item in the sidebar, and right-click on one of the crates listed below the *Crates* sub-item. Select *Remove Crate as Track Source* to remove the crate from the Auto DJ track sources.

### 12.7.3 Riproduzione di tracce in Auto DJ

Ora che hai caricato brani nella playlist Auto DJ, puoi attivare Auto DJ come segue:

- Fare clic sull'icona *Auto DJ* nella barra laterale per passare alla vista *Auto DJ* della libreria.
- Fai clic sul pulsante *Attiva Auto DJ*.
- Le prime tracce della tua lista vengono caricate nei deck e la riproduzione inizia.
- Mixxx continuerà a mixare automaticamente fino a quando la playlist Auto DJ è vuota.
- Fare clic sul pulsante *Disabilita Auto DJ* per interrompere il missaggio automatico

---

**Suggerimento:** You can add a track to the end of the Auto DJ playlist once it is played instead of removing it. Set *Preferences* ▶ *Auto DJ* ▶ *Re-queue tracks after playback* ▶ *On*.

---

### 12.7.4 Auto DJ Mix Modes

Auto DJ has several modes it can use to mix tracks:

- Full Intro + Outro
- Fade At Outro Start
- Full Track
- Skip Silence

The Full Intro + Outro and Fade At Outro Start modes both use the intro and outro cues but the Full Track and Skip Silence cues do not.

### Full Intro + Outro and Fade At Outro Start

The Full Intro + Outro and Fade At Outro start Auto DJ modes use the *intro & outro cues* to determine how long to crossfade and how to align the tracks in time. In both modes, Auto DJ compares the duration of the outro of the old track and the intro of the new track. Auto DJ picks the time of the shorter section as the crossfade time.

In both modes, if the outro is shorter than the intro, Auto DJ will align the start of the outro with the start of the intro.

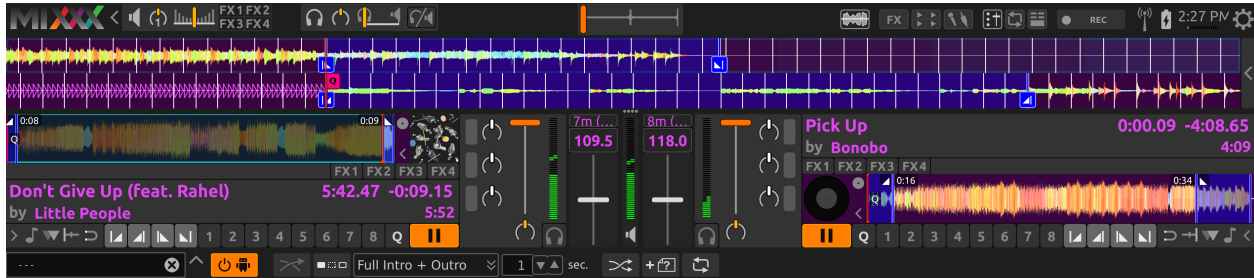

Figure 11: Intro and outro start markers aligned by Auto DJ

The two modes work differently when the outro is longer than the intro.

**Full Intro + Outro Mode** The full length of both the intro and the outro are always played. When the outro is longer than the intro, Auto DJ aligns the end of the intro and outro by starting the next track during the outro of the previous track. This mode is the most likely to sound good with the widest variety of tracks. Therefore, it is the default mode.

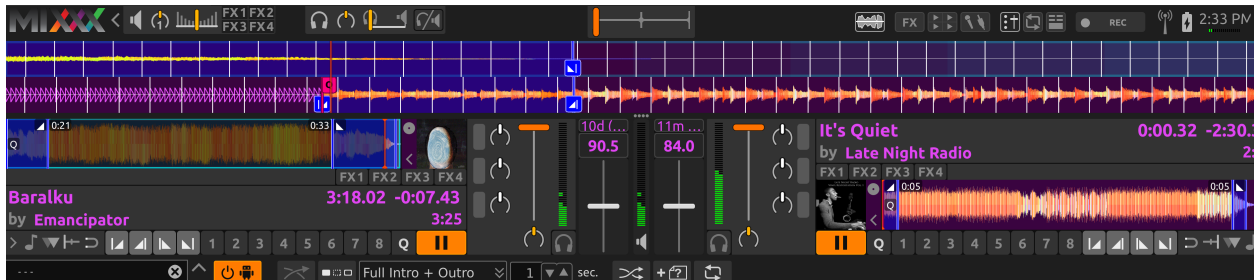

Figure 12: Intro and outro start cues aligned by Auto DJ in Full Intro + Outro mode

**Fade At Outro Start** Auto DJ always aligns the start of the intro and outro. When the outro is longer than the intro, Auto DJ cuts off the end of the outro. This can be helpful if you want to prevent the energy of the mix from declining during a long outro. However, the transition may sound abrupt if the intro is short.



Figure 13: Intro and outro start cues aligned by Auto DJ in Fade At Outro mode

## Full Track and Skip Silence

The Full Track and Skip Silence Auto DJ modes do not use the intro and outro cues. They crossfade tracks over a number of seconds that you specify in the box next to the mode selection menu. The Full Track mode plays the entire length of every file. The Skip Silence mode works the same way but automatically cuts out silence at the beginning and ends of tracks (defined as when the signal first goes above or below -60 dBFS).

---

**Suggerimento:** If you still want to use Auto DJ like a normal music player application, use one of these modes with a transition time of 0 seconds.

---

Mixxx has many options to customize in *Options* ▶ *Preferences*.

## 13.1 Hardware Audio

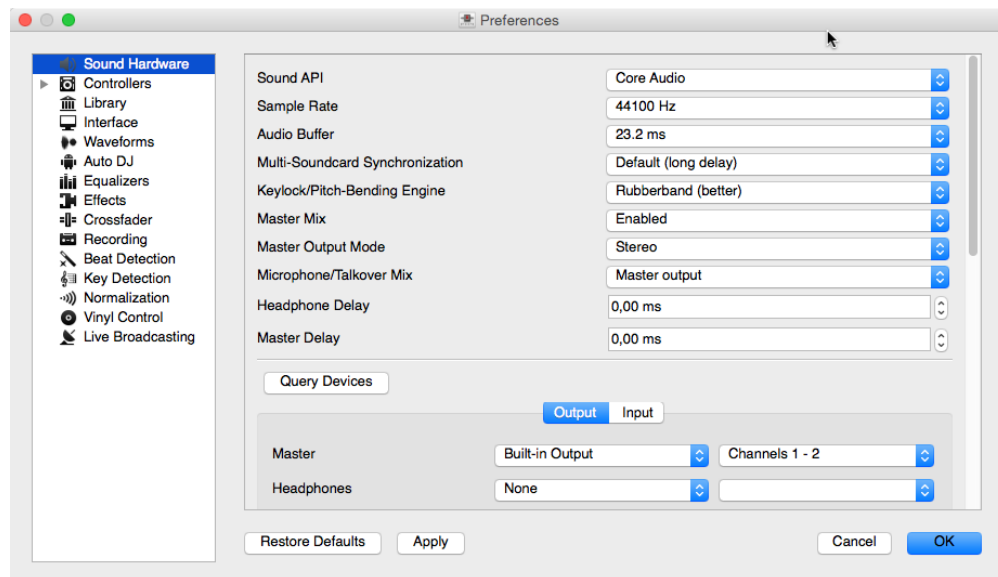

Figure 1: Mixxx Sound Hardware Preferences

To achieve the best performance with Mixxx it is essential to configure your *audio buffer*, *sample rate*, and *audio API*. These three factors largely determine Mixxx's responsiveness and reliability. The optimal settings will vary based on your computer and hardware quality.

For information about the different input and output options, refer to *Configuring sound input and output*. The *DJ Hardware*

chapter explains different types of DJ hardware and how to set them up with the input and output options. If you are using a microphone, refer to the *Using Microphones* chapter.

### 13.1.1 Buffer Audio

The audio buffer is the amount of audio in milliseconds that Mixxx processes at a time. This is a major factor that determines the latency between changing controls in Mixxx such as moving the crossfader or pressing the play button and hearing the audio change. For example, with an audio buffer of 23 ms, it will take approximately 23 milliseconds for Mixxx to stop the audio after you toggle the play button. The actual latency will be longer depending on a variety of factors.

The audio buffer setting determines how quickly your *operating system* expects Mixxx to react. A smaller audio buffer means Mixxx will be more responsive, but requires a faster CPU and quality audio interface. Setting your audio buffer too small may be too much for your computer and audio interface to handle. In this situation, Mixxx playback will be choppy and very clearly distorted as your system will not be able to keep up with how frequently Mixxx is trying to process audio. It is recommended to set your audio buffer as small as your system can handle reliably without glitches. Experiment with different audio buffer sizes to find what works for your system.

An audio buffer between 23-64 ms is acceptable if you are using Mixxx with a keyboard/mouse or a controller. An audio buffer below 10 ms is recommended when vinyl control is used because Mixxx will feel unresponsive otherwise.

The [Adjusting Audio Latency](#) page on the Mixxx Wiki has tips for different operating systems that may help you use a smaller audio buffer reliably.

**Avvertimento:** Your system may glitch only occasionally if you have your audio buffer set a little too low. This will happen at unpredictable times and you may not notice if you are only doing brief tests of each audio buffer size. When you think you have found a good buffer size for your system, play with Mixxx for at least a half hour before performing to ensure no glitches happen.

### 13.1.2 Frequenza di campionamento

The sample rate setting in Mixxx controls how many samples (chunks of audio) per second are produced by Mixxx. This determines the maximum frequency in Mixxx's signal, which is half the sample rate. Humans can only hear up to 20 kHz, so there is generally no need to use more than a 44.1 kHz (44100 Hz) sample rate for playback. Most music is published with a 44100 Hz sample rate, and playing music in a different sample rate than the audio file slightly reduces sound quality.

**Avvertimento:** A sample rate of 96 kHz gives your computer less than half the time to do the same processing. Increasing the sample rate will increase CPU usage and likely raise the minimum audio buffer size you can use reliably.

### 13.1.3 API audio

The Sound *API* that Mixxx uses is the method by which Mixxx talks to your *operating system* in order to deliver audio to your audio interface. Your choice of Sound API can drastically affect Mixxx's performance on your computer. **Therefore it is important to take care to choose the best Sound API available to you.**

## Windows

The following Sound APIs are available on Windows:

- **ASIO**: Good
- **WDM-KS**: Good
- **WASAPI**: Acceptable
- **DirectSound**: Poor
- **MME**: Poor

It is best to use the ASIO Sound API that bypasses the sound processing of the Windows kernel. Using ASIO requires a driver for your audio interface from the manufacturer. Check the manufacturer's website to see if a driver download is available. Soundcards designed for musicians almost always have an ASIO driver available, but audio interfaces built into computers and very cheap audio interfaces typically do not have an ASIO driver. If there is no ASIO driver available for your audio interface, use the WDM-KS API. There is generally no advantage to using [ASIO4ALL](#), a wrapper around the WDM-KS API.

## GNU/Linux

The following Sound APIs are available on GNU/Linux:

- **ALSA**: Good
- **JACK**: Good
- **OSS**: Acceptable

ALSA is the simplest sound API to configure. Using ALSA will prevent any other programs from using the audio interface(s) that Mixxx is using.

JACK allows you to route audio between JACK-compatible applications in flexible ways and output sound from multiple programs at the same time. However, JACK can be complicated to set up. Unless you will be connecting Mixxx to other JACK-compatible applications, JACK offers no advantages over ALSA. To use JACK, start the JACK daemon *before* running Mixxx. Otherwise JACK will not appear as a Sound API in the preferences.

Most modern GNU/Linux distributions use PulseAudio by default. When launched from a GUI menu entry or icon, Mixxx suspends PulseAudio while it is running so that Mixxx can use ALSA directly. Like JACK, PulseAudio allows multiple programs to access one audio interface, but PulseAudio and JACK have opposite design goals. PulseAudio is designed to make ordinary computer usage such as watching videos online and listening to music easy whereas JACK is designed for demanding low latency audio programs like Mixxx. It can be difficult to setup JACK and PulseAudio to work well together. So, unless you already use JACK, it is easiest to let Mixxx suspend PulseAudio and use ALSA.

If the PulseAudio plugin for alsalibs is installed on GNU/Linux, you can choose the virtual device `pulse`. This allows Mixxx to share the default system audio interface with other media players. This only works if you start Mixxx without `pasuspender`, which you can do by running `mi.xxx` from a console rather than clicking the launcher icon in a menu or on your desktop. Since the sound stream is routed from ALSA to Pulse and back to ALSA, this adds an additional latency of  $\sim 2 \times$  the selected audio buffer size.

OSS is an Sound API that predates ALSA. Few modern audio interfaces have OSS drivers.



## macOS

CoreAudio is the only Sound API on macOS.

### 13.1.4 Other Sound Hardware options

- **Multi-Soundcard Synchronization:** Mixxx is able to use two or more *audio interface* at a time, each with its own clock. When multiple audio interfaces are in use, the Mixxx engine is driven by the Master audio interface. Here you can select the synchronization used for the other audio interfaces to avoid buffer overflows or underflows.
- **Keylock/Pitch-Bending Engine:** This allows you to select the engine used for independent tempo and pitch changes (e.g. *key lock*). Use *Soundtouch* on lower power machines (such as netbooks) or if you experience buffer underflows while using *key lock*.
- **Master Mix:** You may disable the master mix to reduce Mixxx's CPU usage if you do not use the Master output, recording or live broadcasting.
- **Master Output Mode:** In Mono mode, the left and right channel are combined into a mono signal which is passed to both channels of your master audio interface. This is useful for setups where the audience cannot hear your mix in stereo because of speaker placement or playing in a space with lots of reverberation.
- **Buffer Underflow Count:** Underflows (data is not available when needed) indicate that some of the subsystems in Mixxx can't keep up with real-time deadlines imposed by the current audio buffer size. This is useful to tune the latency settings. If the counter increases, then increase your audio buffer size, decrease the sample rate setting or change the sound API setting if available.

## 13.2 Libreria

### 13.2.1 Changing music directories

You can manually add, relink, and remove Mixxx music directories in *Preferences ▶ Library*.

**Add a new music directory** Mixxx handles multiple music library folders. Click *Add* to browse to a directory where your music is stored. Mixxx will watch this directory and its subdirectories for new tracks.

If you add a directory that is already in your library, or you are currently *rescanning your library*, the operation is canceled.

Directories can also be added from the *Computer* sidebar item inside the library.

**Relink a existing music directory** If an existing music directory is moved or renamed, Mixxx doesn't know where to find the audio files in it. The tracks will still show in library but they can't be loaded on decks and the tracks will become missing after the library is rescanned.

To relink the music directory, go to *Preferences ▶ Library*, click *Relink* to select the music directory in its new location. This will re-establish the links to the audio files in the Mixxx library.

Click *Library ▶ Rescan Library*, this will update the tracks and cause them to show up again in the library, check the location column in the library and you should see that it now points to the new music directory.

The playlists, crates, history and all track data like cue points, rating, comments etc. are preserved after relinking the library, the tracks are also not re-analyzed as the cached analysis is reused. You can confirm this by checking the *Key* and *BPM* columns to see if there is a key and BPM for every track.

---

**Nota:** It is recommended to take a backup of your Mixxx configuration files before moving or renaming music directories used in Mixxx. The location of Mixxx configuration files vary based on the *operating system*:

- Windows: %USERPROFILE%\Local Settings\Application Data\Mixxx\
- macOS: Library/Application Support/Mixxx
- Linux: The configuration files are found in the `.mixxx` folder in your home directory.

**Remove a music directory** Click *Remove*, and Mixxx will no longer watch a directory and its subdirectories for new tracks, and asks what would you like to do with the tracks from these directories.

- Select *Hide Tracks* to hide all tracks from this directory and subdirectories.
- Select *Delete Track Metadata* to delete all metadata for these tracks from Mixxx permanently
- Select *Leave Tracks Unchanged* to leave the tracks unchanged in your library.

Hiding tracks saves their metadata in case you re-add them in the future.

Metadata significa tutti i dati della traccia (artista, titolo, etc.) e anche beatgrids, hotcues, e loop. Questo riguarda solo la libreria Mixxx. Non verranno modificati o cancellati i files sul disco.

**Suggerimento:** When changing music directories, you might want to run a library rescan afterwards. Select *Library ▸ Rescan Library* in the menu.

## 13.3 Colors

### 13.3.1 Selecting Palettes and Default Colors

**Track/Hotcue Palette** It is possible to assign colors to tracks and *hotcues* to highlight them. Mixxx offers a selection of different palettes that you can choose colors from.

You can also make your own palette by clicking the *Edit* button next to the palette name. This will open a the *palette editor*.

**Default Hotcue Color** It is possible to either select a single color from the current hotcue palette that will be assigned to all newly created hotcue colors, or select the *By hotcue number* option. The latter will automatically assign a color from the palette to new hotcues based on the hotcue number.

### 13.3.2 Editing Palettes

The palette editor allows you add, modify, reorder and remove colors in a color palette and save it under a new name. You can also delete custom palettes.

To modify a color, double-click it to open the color picker window.

When editing the hotcue palette, the palette editor also allows assigning a specific default color to a hotcue number. This setting is honored when *Hotcue default color* is set to *By hotcue number*.

That makes it possible to assign just a few distinct colors to your hotcues automatically, but still have more colors available in the palette in case you want to override the color manually.

For example, if you have a color palette consisting of 4 colors, and you configure the palette to assign the first color to hotcue 1 and the third color to hotcue 2, then hotcue 1 will use the first color and hotcue 2 will be assigned the third color. The colors will repeat when setting a hotcue with a number greater than those used in the palette. In the example above, hotcue 3 will use the first color and hotcue 4 the second color, and so on.

You can also assign the same color to more than one hotcue. For example by separating the hotcue numbers with a comma (“2, 4, 7”), expressing a range of numbers (“1 - 3”) or any combination of that (“6, 1 - 3, 7”).

If no color in the palette has a hotcue number assigned to it, new hotcues will use the color at the same index from the palette (i.e. hotcue 1 will be assigned the first color in the palette, hotcue 2 uses the second color in the palette, etc.).

### 13.3.3 Replacing Hotcue Colors

Sometimes it’s necessary to bulk replace colors of existing hotcues in your library. Instead of changing the color of every single hotcue manually, you can *Replace* to open the cue color replace dialog.

In addition to selecting the new color, you may set conditions that determine which hotcues the new color will be assigned to. If you tick both checkboxes, the new color will only applied if both conditions match.

## 13.4 Riconoscimento Beat

Mixxx uses an ultra-precise BPM and beat detector. Manual adjustments are redundant in many cases because Mixxx knows where the beats are.

BPM and beat detection is a complex operation. Depending on your computer and the track’s bitrate and duration this may take some time. By default Mixxx analyzes the complete track. To accelerate beat detection on slower computers, a “Fast Analysis” option is available. If enabled, the BPM is computed by analyzing the first minute of the track. In most cases this does not affect the beat detection negatively because most of today’s dance music is written in a 4/4 signature with a fixed tempo.

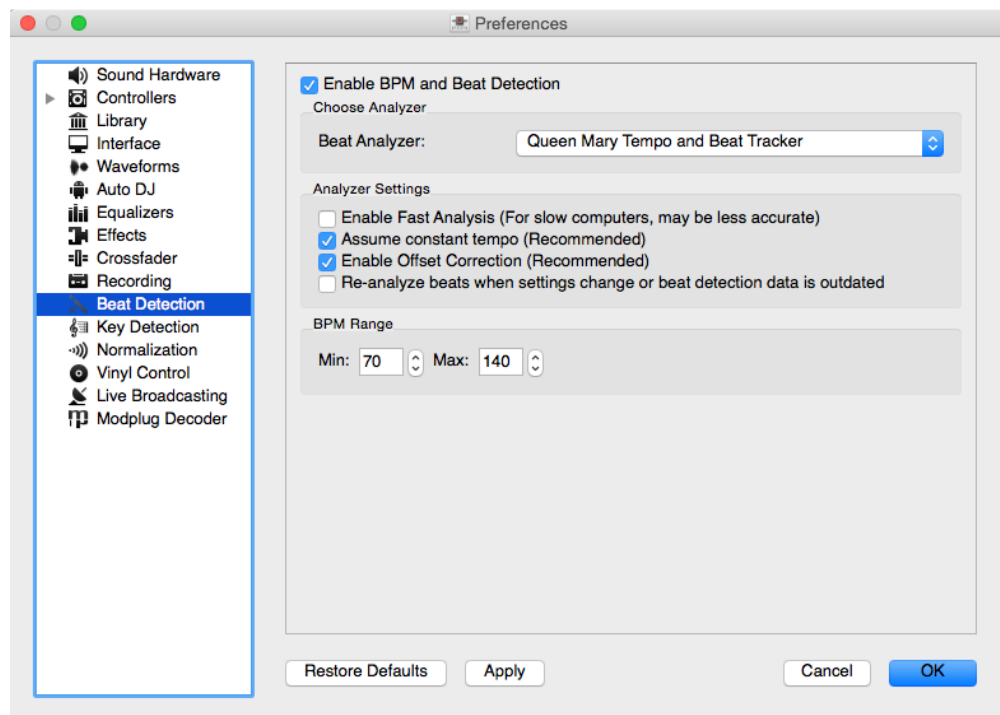

Figure2: Mixxx preferences - BPM settings

The table below summarizes the beat detection settings:

| Option  | Descrizione  |
|---|--|
| Enable Fast Analysis  | If enabled, BPM will be detected by only using the first minute of audio.  |
| Assume un tempo costante  | If enabled, Mixxx assumes that the distances between the beats are constant. If disabled, the raw beat grid obtained by the analyzer is presented. The latter is appropriate for tracks with variable tempo. |
| Enable Offset Correction  | Prevents beat markers from being placed incorrectly.   |
| Rianalizza battute quando le opzioni cambiano o le informazioni sulla traccia sono obsolete | If enabled, Mixxx over-writes old beat grids from prior versions. Moreover, it will re-analyze the BPM if your beat detection preferences change or BPM data from 3rd party programs are present.            |

### 13.4.1 Correcting Beat Grids

There may be situations where BPM and beat detection do not result in a proper beat grid.

Typically, the detected BPM is correct but the analyzer has failed to detect the location of the first beat. Consequently, the beat markers are shifted, i.e. the beat markers are a fixed distance from the true beat. To adjust the beat grid, cue the track before a real beat and click the *Beat-grid Adjust* button in the *Deck Options Button Grid*.

If the detected BPM is not accurate, the corresponding beat grid will also be inaccurate. A deviation of 0.02 BPM units from the correct BPM will cause beatgrid alignment issues on long tracks (e.g. a club mix). If this happens, your beatgrid may look aligned for the few minutes but you will notice a slight drift as the song goes on. Finding the correct BPM is easy in many cases - just follow the note below.

---

**Nota:** If the detected BPM value is not sufficiently accurate but very close to an integer value, try to set the BPM value manually to the integer.

---

## 13.5 Rilevamento della chiave

Mixxx comes with a high precision musical key detector to help you make smooth mixes by ensuring that your tracks are musically compatible.

### 13.5.1 Impostazioni dell'analizzatore

Key detection is a complex operation. Depending on your computer and the track's bitrate and duration this may take some time. By default Mixxx analyzes the complete track. To accelerate key detection on slower computers, a "Fast Analysis" option is available. If enabled, the key is computed by analyzing the first minute of the track.

The table below summarizes the Key detection settings:

| Option  | Descrizione   |
|---|---|
| Enable Fast Analysis  | If enabled, the key will be detected by using only the first minute of audio.   |
| Re-analyze key when settings change or Key detection data is outdated | If enabled, Mixxx will re-analyse tracks if you select a different key detection plugin or the key was generated by a program other than Mixxx. |
| Notazione chiave  | Change the way keys are displayed in the library.   |

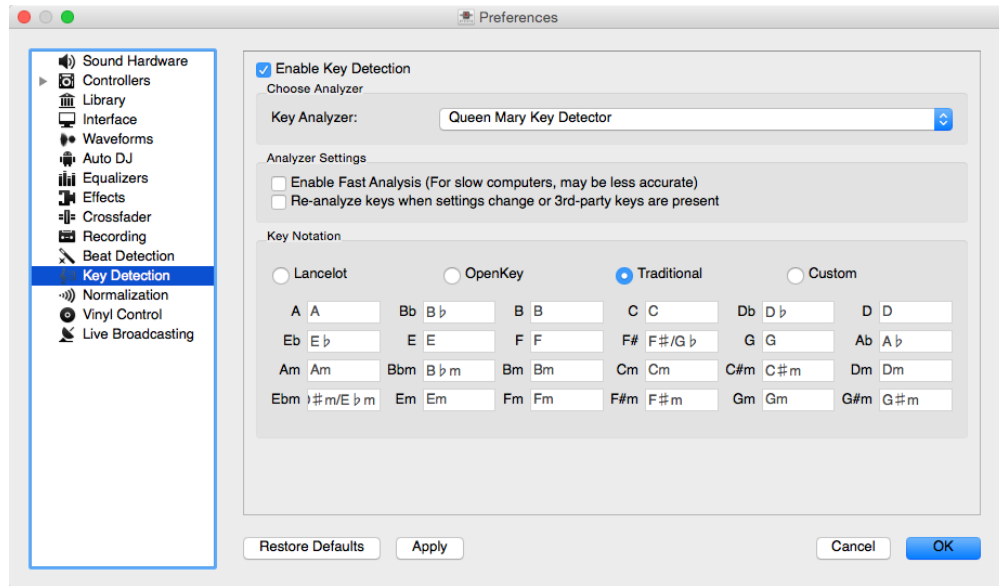

Figure3: Mixxx preferences - Key settings

## 13.6 Equalizzatori

*Preferences* ▶ *Equalizer* allows you to setup the equalizers.

- **Equalizer Rack:** The Equalizer Rack is a special effect rack that is connected to the deck's equalizer and filter controls.
- **Equalizer Plugin:** Here you can select the effect that is used as the mixing EQ in each deck. By default only built-in equalizers are displayed. Unchecking *Only allow EQ knobs to control EQ specific effects* allows you to select any other effect.
- **Quick Effect:** Here you can select the effect that is controlled by the dedicated filter knob in each deck. By default only built-in filter effects are selected for all decks, but that can be changed as above.
- **High/Low Shelf EQ:** This slider sets the crossover frequencies of the mixing EQ. It controls which frequency range is affected by the low, mid, and high channel EQ knobs. By default the low knob controls the bass and sub bass range up to 246 Hz. The mid knob controls the mid range up to 2.5 kHz. The remaining treble range is controlled by the high knob.
- **Master EQ:** This section allows you to setup an EQ that affects the master output.

### 13.6.1 Mixing Equalizers

Mixxx offers three types of mixing equalizers with a full kill option. These equalizers are «isolators», adapted from analog crossover networks. Each EQ is combination of a high shelf filter, a band pass filter, and a low shelf filter. Each EQ type has a unique sound, so try them out to find out which one you prefer.

The Bessel EQs with Lipshitz and Vanderkooy Mix (LV-Mix) do not alter the sound or take any processing time when their knobs are in the center position. They activate once you adjust an EQ knob.

The Linkwitz-Riley EQ on the other hand always applies a minimum, natural sounding phase shift to the sound. Their processing time does not change when you adjust the EQ knobs.

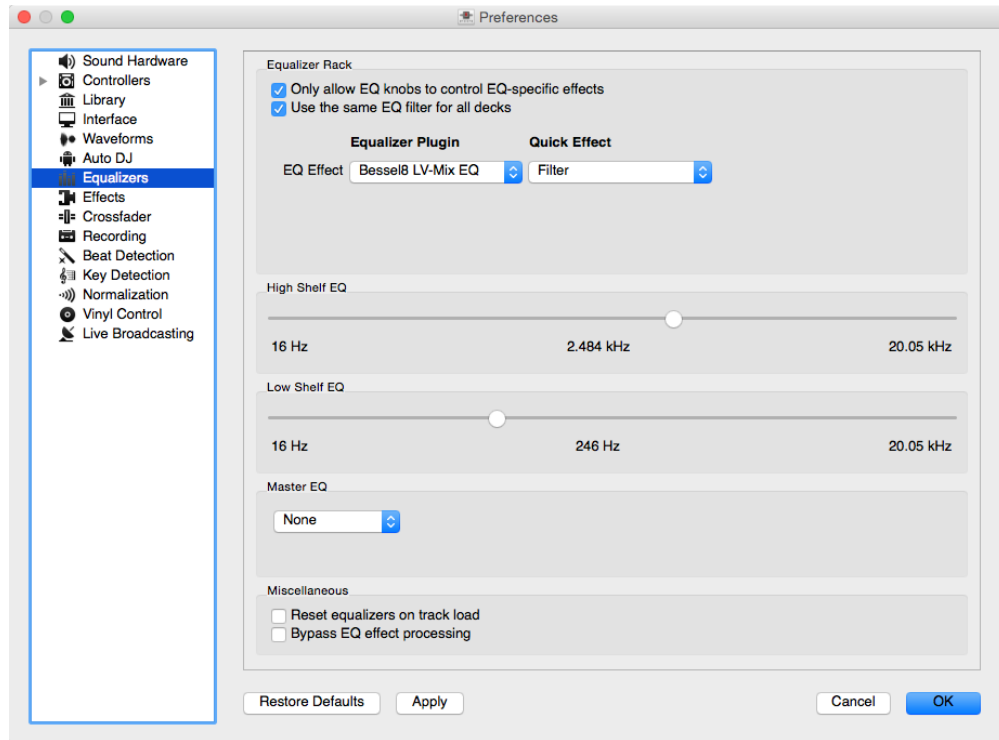

Figure4: Preferenze Equalizzatore

The following table compares some technical parameters:

| Digita         | cut    | roll-off   | phase shift | bit perfect | CPU usage |
|----------------|--------|------------|-------------|-------------|-----------|
| Bessel4 LV-Mix | soft   | -24 db/Oct | linear      | yes         | low       |
| Bessel8 LV-Mix | medium | -48 db/Oct | linear      | yes         | medium    |
| Linkwitz-Riley | sharp  | -48 db/Oct | minimum     | no          | high      |

- cut: the frequency response (curve form) at the cross over frequency.
- roll-off: The steepness of the EQ bands.
- linear phase: No phase distortion, all frequencies are processed with the same group delay.
- minimum phase: A natural phase distortion, the group delay changes by the frequency.
- bit perfect: Whether the EQ leaves the original samples untouched when the EQ is at unity.
- CPU usage: Processing time needed to calculate the EQ output.

### 14.1 Con diverse dozzine di controller DJ supportati immediatamente, Mixxx offre un controllo hardware completo per i tuoi mix DJ, vedi: ref: *control-midi*.

With several dozens of DJ controllers supported out-of-the-box, Mixxx gives you comprehensive hardware control for your DJ mixes, see *Using MIDI/HID Controllers*.

Support for additional devices can be added to Mixxx by creating a new mapping file. This file tells Mixxx how to translate, or map, *MIDI/HID* messages from a controller into commands that Mixxx understands.

You can download and share custom controller mappings in the [Mixxx User customizations forums](#).

For a list of controls that can be used in a controller mapping, see *Mixxx Controls*.

#### 14.1.1 Controller Wizard

By far, the easiest way to create a new MIDI mapping is by using the Controller Wizard.

1. Connect your controller(s) to your computer
2. Start Mixxx
3. Go to *Preferences* ▶ *Controllers*
4. Select your device from the list of available devices on the left, and the right pane will change
5. Activate the *Enabled* checkbox
6. Click on *Learning Wizard* to open the selection dialog
7. Click any control in the Mixxx *GUI*
8. Alternatively, click the *Choose Control* button and choose one from the selection list

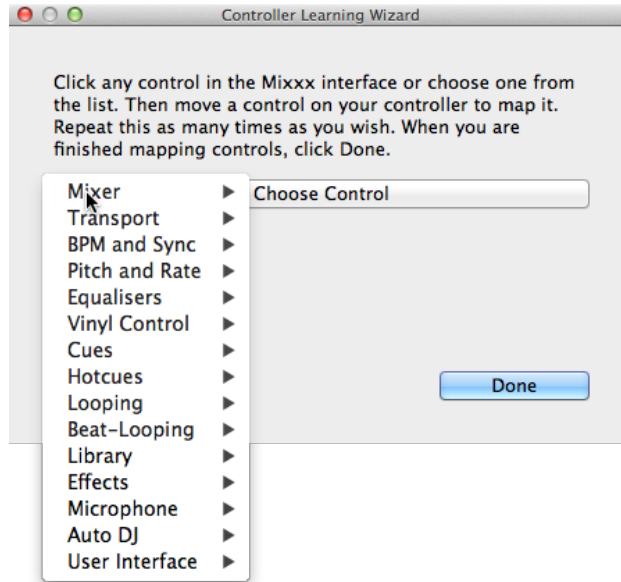

Figure1: Mixxx Controller Wizard - Mapping a control

9. Push *Learn* and then move a control or push a button on your controller to map it. You can also move a control without pushing the *Learn* button if you are learning many controls.
10. If you are learning a button, just push it once. If you are learning a knob or a slider, try to move it throughout its range.
11. After Mixxx detects the control, you may click *Learn Another* or you can click on another button in the Mixxx *GUI* to learn another control.
12. When you are finished mapping controls, click *Done*

There are also some advanced options in the Midi Wizard you may need to use:

- **Soft Takeover:** Use this option for knobs or sliders to avoid sudden jumps in when the knob in the *GUI* doesn't match the physical knob. If you select this option, you won't be able to perform super-fast motions as easily. (Recommended off)
- **Invert:** Use this option for controls that you want to work backwards from how they were detected.
- **Switch Mode:** Use this option on controllers that have controls that act like switches and emit one value on the first press, and a different value on the next press. (Think an actual hardware toggle switch, or a button that lights up on the first press and turns off on the second press).
- **Jog Wheel / Select Knob:** Use this for knobs that don't have a beginning or an end, but spin continuously.

The Controller wizard saves the new mapping to the following file paths:

- **Linux:** /home/<username>/.mixxx/controllers
- **macOS:** /Users/<username>/Library/Containers/org.mixxx.mixxx/Data/Library/Application Support/Mixxx/controllers
- **Windows:** %LOCALAPPDATA%\Mixxx\controllers

You can then modify the XML file it creates (or any of the ones that ship with Mixxx) if you'd like to fine-tune it or add more mappings. For more information, go to <https://github.com/mixxxdj/mixxx/wiki/MIDI-Controller-Mapping-File-Format>.

**14.1. Con diverse dozzine di controller DJ supportati immediatamente, Mixxx offre un controller hardware completo per i tuoi mix DJ, vedi: ref: *control-midi*.**



The Controller Wizard works only for *MIDI* devices. Currently you can't map modifier (shift) keys and platter rotations. Use *MIDI Scripting* instead.

### 14.1.2 MIDI Scripting

In order to support the advanced features of many *MIDI/HID* controllers, Mixxx offers what we call MIDI Scripting.

It enables MIDI controls to be mapped to *QtScript* (aka Javascript/EMCAScript) functions stored in function library files, freeing Mixxx from a one-to-one MIDI mapping ideology. These user-created functions can then do anything desired with the MIDI event such as have a single controller button simultaneously affect two or more Mixxx properties ("controls"), adjust incoming control values to work better with Mixxx (scratching), display a complex LED sequence, or even send messages to text displays on the controller.

For more information, go to <https://github.com/mixxxdj/mixxx/wiki/Midi-Scripting> and [https://github.com/mixxxdj/mixxx/wiki/hid\\_mapping\\_format](https://github.com/mixxxdj/mixxx/wiki/hid_mapping_format).

## 14.2 Making a Custom Keyboard Mapping

The *default keyboard mappings* are defined in a text file which can be found at the following location:

- Linux: `/usr/local/share/mixxx/keyboard/en_US.kbd.cfg`
- macOS: `/Applications/Mixxx.app/Contents/Resources/keyboard/en_US.kbd.cfg`
- Windows: `<Mixxx installation directory>\keyboard\en_US.kbd.cfg`

Depending on your system's language settings, Mixxx might use a different file as default, e.g. `de_DE.kbd.cfg` for German or `es_ES.kbd.cfg` for Spanish.

It is not recommended that you modify the system-wide keyboard mapping file because all your changes may be lost if you uninstall or upgrade Mixxx. Instead, copy the default mapping file to the following location:

- Linux: `~/.mixxx/Custom.kbd.cfg`
- macOS: `~/Library/Containers/org.mixxx.mixxx/Data/Library/Application Support/Mixxx/Custom.kbd.cfg`
- Windows: `%LOCALAPPDATA%\Mixxx\Custom.kbd.cfg`

Then edit this file and save the changes. On the next startup, Mixxx will check if `Custom.kbd.cfg` is present and load that file instead of the default mapping file. This has the advantage that you can always revert back to the default mapping by deleting `Custom.kbd.cfg`.

For a list of controls that can be used in a keyboard mapping, see *Mixxx Controls*.

You can download and share custom keyboard mappings in the [Mixxx User customizations forums](#).

## 14.3 Additional Effects via external Mixer Mode

Mixxx comes with a set of *native effects*. Additionally, using the *external mixer mode* you can route each deck directly to 3rd party effect hosts.

The following examples are only intended to encourage experimentation, they are not definitive guidance.

### 14.3.1 Effects via AU Lab on macOS

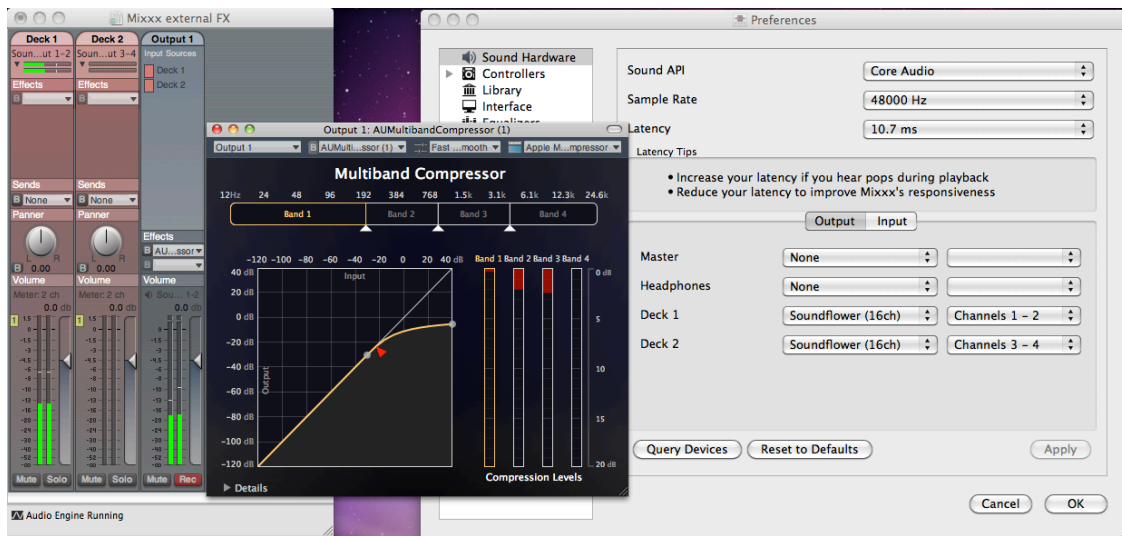

Figure2: The Au Lab routing for external effects on macOS

On macOS there is a simple and free way to give Mixxx access to the collection of AU/VST/MAS plugins that are installed on your system.

- Install the free [SoundflowerBed](#), a system extension for inter-application audio routing.
- Install the free digital audio mixing application [AU Lab](#).

**Suggerimento:** macOS 10.15 (Catalina) introduces additional restrictions on running non-Apple software. Make sure to grant permission in *System Preferences* → *Security & Privacy* → *Microphone* → *AU Lab*.

Alternatively, try [Blackhole](#), a modern virtual audio driver that allows applications to pass audio to other applications with zero additional *latency*, and [Hosting AU](#), a free micro-sized *DAW* that hosts Audio Unit instruments and effect plugins.

#### In Mixxx

- Go to *Preferences* ▶ *Sound Hardware* ▶ *Output*
- Select for *Deck 1* the *Soundflower 16* device with *Channel 1-2*
- Select for *Deck 2* the *Soundflower 16* device with *Channel 3-4*
- Click the *Apply* button

#### In AU Lab

- Click on the + button to create a new configuration
- Add 2 stereo input tracks in the *Audio Input Tab*
- Add 2 stereo output tracks in the *Audio Output Tab*
- Click *OK*
- Change the audio input device to *Soundflower 16*
- Change the audio output device for example to *Built-in Output*
- Click *Create document*

- In the *Output 1* channel, select an effect from the drop-down menu, for example *Apple* ▶ *AUCompressor*

The effect should now react if you play a track in Mixxx.

### 14.3.2 Effects via JACK Rack on GNU/Linux

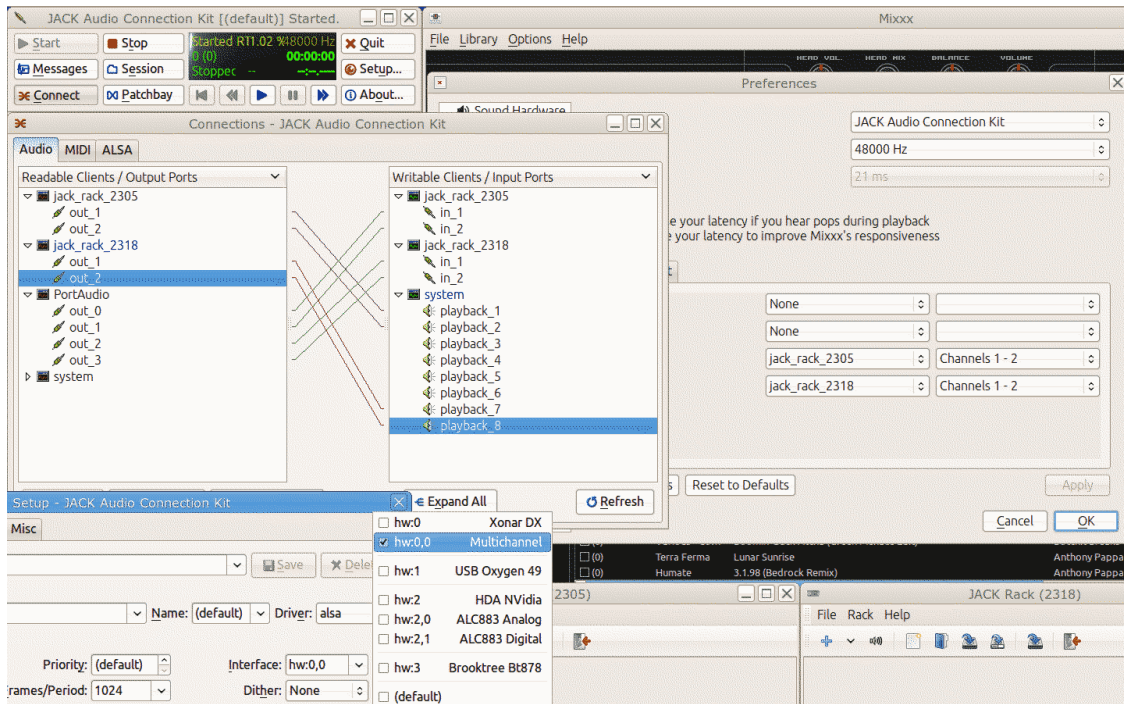

Figure3: The Jack routing for external effects on GNU/Linux

Use *Jack* to route each deck directly through *JACK Rack* effect racks, or for more control you can use *Ardour* (or another *DAW*) using sends for effects. This gives Mixxx access to the extensive collection of *LADSPA* plugins.

Make sure the correct multichannel audio interface has been selected in Jack (Jack settings visible bottom left). Note that Mixxx possibly labels its Jack ports as *Portaudio*.

## 14.4 Deleting Your Library

The library file is stored in the following places depending on your *operating system*:

**Windows** The Mixxx library is stored in the %USERPROFILE%\Local Settings\Application Data\Mixxx\ folder. To delete your library on Windows, delete the `mixxxdb.sqlite` file in this folder.

**macOS** The Mixxx library is stored in the `Library/Application Support/Mixxx` folder in your home directory. To delete your library on macOS type the following command into a terminal:

```
rm ~/Library/Application\ Support/Mixxx/mixxxdb.sqlite
```

**GNU/Linux** The Mixxx library is stored in the `.mixxx` folder in your home directory. To delete your library on GNU/Linux type the following command into a terminal:

```
rm ~/.mixxx/mixxxdb.sqlite
```

**Avvertimento:** Deleting your library will lose all of your *metadata*. This includes saved hotcues, loops, comments, ratings, and other library related metadata. Only delete your library if you are fine with losing these.

---

## Contributing to the Project

---

Mixxx is a community-driven project involving many DJs worldwide. Without the contributions from these DJs, Mixxx would not exist, and we're constantly looking for more contributors.

We want to make it as easy as possible for people to get involved in Mixxx development. First off, to be clear **you don't have to be a programmer to contribute**.

### 15.1 As a non-developer

- [Donate](#) to Mixxx using Paypal to help support and enhance development.
- [Make skins](#)
- [Make MIDI mappings](#) for your controller
- [Report bugs](#)
- Update our [Wiki](#) to make sure the information on it is up to date.
- Translate Mixxx using [Transifex](#)
- Answer questions on the [Troubleshooting Forum](#) and the [Launchpad Answers page](#)
- Help promote Mixxx: If you've got a blog, write an article about Mixxx. Blog about our new releases when they come out. Any exposure on the web and in print helps our project grow, and is much appreciated.
- Send us some photos of you using Mixxx at a gig!

## 15.2 As a software developer

- You don't have to know C++. There are developers who got into Mixxx development while learning C++ along the way.
- Join our mailing list: [mixxx-devel](#)
- Join our [Zulip](#) chat.
- Tell us your ideas! Email us, talk on [Zulip](#), file wishlist [bugs](#), or post on the forums.
- Register an account on our development platform [Github](#) and fork our code. See [Using Git for Mixxx Development](#)
- Join the [Mixxx Development Team](#) on Launchpad.
- Get familiar with the code. Pick a bug off of the [Easy Bug List](#)
- Get help fixing the bug on [Zulip](#), talk to us about the best way to do it.

### Contributing to Mixxx in 3 Easy Steps:

1. Pick a bug off of the [Easy Bug List](#)
2. Talk to us on [Zulip](#) for help on how to fix it.
3. Fix it! *Done!* Your name will now be on the [Mixxx contributor list](#).

## 16.1 Keyboard mapping table

Shortcuts let you work more efficiently. This table lists the default keyboard shortcuts for accessing Mixxx with an English keyboard layout. Depending on your language settings the defaults may be different.

| <b>Mixer</b>                     |           |        |
|----------------------------------|-----------|--------|
| Crossfade Left                   | G         |        |
| Crossfade Right                  | H         |        |
| Small Crossfade Left             | Shift + G |        |
| Small Crossfade Right            | Shift + H |        |
| Microphone Talkover              | `         |        |
|                                  | Deck 1    | Deck 2 |
| Activate/Disable Effects Unit    | 5         | 0      |
| Headphone Cue (Pre-fader listen) | T         | Y      |
| Bass Kill                        | B         | N      |

| <b>Playback</b>                   | <b>Deck 1</b>   | <b>Deck 2</b>   |
|-----------------------------------|-----------------|-----------------|
| Load selected track to deck       | Shift + ←       | Shift + →       |
| Unload track from deck            | Alt + Shift + ← | Alt + Shift + → |
| Playback                          | D               | L               |
| Seek Backwards                    | A               | J               |
| Reverse Playback                  | Shift + A       | Shift + J       |
| Seek Forwards                     | S               | K               |
| Tempo Adjust Down                 | F1              | F5              |
| Tempo Adjust Up                   | F2              | F6              |
| Small Tempo Adjust Down           | Shift + F1      | Shift + F5      |
| Small Tempo Adjust Up             | Shift + F2      | Shift + F6      |
| Temporary Tempo Adjust Down       | F3              | F7              |
| Temporary Tempo Adjust Up         | F4              | F8              |
| Small Temporary Tempo Adjust Down | Shift + F3      | Shift + F7      |
| Small Temporary Tempo Adjust Up   | Shift + F4      | Shift + F8      |
| Tempo (BPM) Sync                  | 1               | 6               |
| BPM Tap Tempo Adjust              | Shift + !       | Shift + ^       |

| <b>Cue and Loop</b>                 | <b>Deck 1</b> | <b>Deck 2</b> |
|-------------------------------------|---------------|---------------|
| Set Cuepoint                        | Shift + D     | Shift + L     |
| Cue                                 | F             | ;             |
| Cue Go-to-and-stop                  | Shift + F     | Shift + :     |
| Activate 4 Beat Loop                | Q             | U             |
| Halve Beat Loop Size                | W             | I             |
| Double Beat Loop Size               | E             | O             |
| Set Loop In Point                   | 2             | 7             |
| Set Loop Out Point (Activates Loop) | 3             | 8             |
| Toggle Loop On/Off                  | 4             | 9             |
| Set Hot cue 1                       | Z             | M             |
| Set Hot cue 2                       | X             | ,             |
| Set Hot cue 3                       | C             | .             |
| Set Hot cue 4                       | V             | /             |
| Clear Hot cue 1                     | Shift + Z     | Shift + M     |
| Clear Hot cue 2                     | Shift + X     | Shift + <     |
| Clear Hot cue 3                     | Shift + C     | Shift + >     |
| Clear Hot cue 4                     | Shift + V     | Shift + ?     |

| <b>Vinyl Control</b>            | <b>Deck 1</b>    | <b>Deck 2</b>    |
|---------------------------------|------------------|------------------|
| Passthrough                     | Ctrl + J         | Ctrl + K         |
| Vinylcontrol Mode               | Ctrl + Shift + Y | Ctrl + Shift + U |
| Vinylcontrol Cueing             | Ctrl + Alt + Y   | Ctrl + Alt + U   |
| Single Deck Toggle / Swap Decks | Ctrl + T         |                  |



| <b>Library</b>                        |   |
|---------------------------------------|---|
| Maximize the library view             | Space   |
| Load selected track to deck           | Shift + ← (Deck 1)   Shift + → (Deck 2)           |
| Select all files in current list      | Ctrl + A  |
| Select group of files in current list | Click first item, hold Shift key, click last item |
| Focus search bar                      | Ctrl + F  |
| Clear search input                    | Ctrl + Back                                       |
| Exit search and leave focus           | ESC   |

| <b>Preview Deck</b>          |              |
|------------------------------|--------------|
| Load Selected Track And Play | Alt + Return |
| Start/Stop                   | Return       |
| Seek Backwards               | Alt + ←      |
| Seek Forwards                | Alt + →      |

| <b>Auto DJ</b>                |             |
|-------------------------------|-------------|
| Shuffle Auto DJ playlist      | Shift + F9  |
| Skip next track in Auto DJ    | Shift + F10 |
| Fade to next track in Auto DJ | Shift + F11 |
| Toggle Auto DJ on/Off         | Shift + F12 |

**Vedi anche:**

Mixxx allows you to customize the keyboard shortcuts. For more information, and to download a keyboard mapping image, go to [Using a Keyboard](#).

## 16.2 Application shortcuts

Use these shortcuts to access features available in the menu on top of the application window.

| Function                      | Key                 |
|-------------------------------|---------------------|
| <b>File menu</b>              |                     |
| Load Track to Deck 1          | Ctrl + O            |
| Load Track to Deck 2          | Ctrl + Shift + O    |
| <b>Library menu</b>           |                     |
| Add new Playlist              | Ctrl + N            |
| Add new Crate                 | Ctrl + Shift + N    |
| <b>View menu</b>              |                     |
| Show Skin Settings Menu       | Ctrl + 1            |
| Show Microphone Section       | Ctrl + 2            |
| Show Vinyl Control Section    | Ctrl + 3            |
| Show Preview Deck             | Ctrl + 4            |
| Show Cover Art                | Ctrl + 6            |
| Maximize Library              | Space               |
| Full Screen (Windows & Linux) | F11                 |
| Full Screen (macOS)           | Shift + Command + F |
| <b>Options menu</b>           |                     |

continues on next page

Table 1 – continua dalla pagina precedente

| Function                           | Key              |
|------------------------------------|------------------|
| Enable Vinyl Control 1             | Ctrl + T         |
| Enable Vinyl Control 2             | Ctrl + Y         |
| Enable Vinyl Control 3             | Ctrl + U         |
| Enable Vinyl Control 4             | Ctrl + I         |
| Enable Live Broadcasting           | Ctrl + L         |
| Record Mix                         | Ctrl + R         |
| Enable Keyboard Shortcuts          | Ctrl + `         |
| Open Preferences (Windows & Linux) | Ctrl + P         |
| Open Preferences (macOS)           | Ctrl + ,         |
| Exit Mixxx                         | Ctrl + Q         |
| <b>Developer menu</b>              |                  |
| Reload skin                        | Ctrl + Shift + R |
| Developer Tools                    | Ctrl + Shift + T |
| Stats: Base Bucket                 | Ctrl + Shift + B |
| Stats: Experiment Bucket           | Ctrl + Shift + E |
| Debugger Enabled                   | Ctrl + Shift + D |

**Suggerimento:** The `Ctrl` key on Windows & Linux is equivalent to the `Command` key on macOS. The `Alt` key on Windows & Linux is equivalent to the `Option` key on macOS. Application shortcuts are not customizable.

**Nota:** The Developer menu is available if Mixxx is started using the *Launching Mixxx from the Command Line*.

## 16.3 Launching Mixxx from the Command Line

To launch Mixxx using the command line:

**Windows** Locate the folder where Mixxx is installed and copy the file path. You can also obtain the file path by right clicking on the Mixxx icon and then choosing “Properties”. Copy the path and paste it in terminal and add `\mixxx` at the end - everything should be inside quotes. Press Enter. The entire command will look like this

```
"C:\Program Files\Mixxx\mixxx"
```

**macOS** Similarly, for macOS, the command will be

```
/Applications/Mixxx.app/Contents/MacOS/mixxx
```

**GNU/Linux** If Mixxx is in your system’s search path (`$PATH`), you can just type

```
mixxx
```

### 16.3.1 Command line options

Mixxx is designed to be as user-friendly as possible. As such, its command line options are only useful for development or debugging, as they make these tasks easier. Command line options are case-sensitive.

To launch Mixxx with any of these command line options, simply append the option to the base command for your operating system. For example, to launch Mixxx in developer mode on Windows, type this in terminal

```
"C:\Program Files\Mixxx\mixxx" --developer
```

In addition to these options, it is possible to specify one or more music file(s) on the command line. These will be loaded at start-up. Each file you specify will be loaded into the next virtual deck. For a list of supported file types, go to *Compatible file formats*.

- resourcePath PATH** Top-level directory where Mixxx will look for its resource files such as MIDI mappings, overriding the default installation location.
- pluginPath PATH** Top-level directory where Mixxx will look for sound source plugins in addition to default locations.
- settingsPath PATH** Top-level directory where Mixxx will look for user settings files such as the library database and preferences configuration file.
- controllerDebug** Log all controller data Mixxx sends and receives as well as scripts it loads.
- developer** Enable developer mode. Includes extra logs, stats on performance and the Developer tools menu as well as tooltips and logs useful for skin developers.
- safeMode** Disable OpenGL widgets (scrolling waveforms, spinnies) to work around GPU driver bugs. If Mixxx is crashing on startup, try using this.
  - Automatically loads empty waveforms
  - Disables spinning vinyl widgets
  - Disables synchronization polling
  - Doesn't open controllers by default
- locale LOCALE** Use a custom locale for loading translations (e.g fr)
- f, --fullScreen** Start Mixxx in full-screen mode.
- logLevel LEVEL** Set the verbosity of command line logging.

| Value    | Meaning                          |
|----------|----------------------------------|
| critical | Critical/Fatal only              |
| warning  | Above + Warnings                 |
| info     | Above + Informational messages   |
| debug    | Above + Debug/Developer messages |
| trace    | Above + Profiling messages       |

- logFlushLevel LEVEL** Set the logging level at which the log buffer is flushed to `mixxx.log`. LEVEL is one of the values defined at `--logLevel` above.
- debugAssertBreak** Breaks (SIGINT) Mixxx if a `DEBUG_ASSERT` evaluates to false. A debugger can then be used to continue. This disables the `MIXXX_DEBUG_ASSERTIONS_FATAL` flag which can otherwise lead to a time consuming full rebuild.
- h, --help** Display this help message and exit

## 16.4 Developer tools

To start Mixxx in Developer mode from a custom resource directory with *MIDI* and *HID* logging enabled, type the following line into the terminal and hit return:

```
./mixxx --controllerDebug --developer --resourcePath res
```

### 16.4.1 Experiment modes for rapid development and testing

- Adds a static Experiment class with a tri-state mode flag that indicates whether the experiment mode is OFF, BASE, or EXPERIMENT.
- Adds *Developer* ▶ *Stats:Experiment Bucket* and *Developer* ▶ *Stats:Base Bucket*. Each one toggles between OFF and BASE/EXPERIMENT so you can choose exactly what time spans you would like to collect in your base and experiment buckets.
- Updates StatsManager to segment collected stats into a base and experiment bucket. This allows you to quickly measure the difference a code change has on relevant counters / timers within the same execution of Mixxx.

This is useful for quickly enabling and disabling a code change without a re-compile/re-run cycle to get an anecdotal sense of how it «feels» as well as a quantified sense of how it differs in terms of stats Mixxx collects.

All stats collected via the usual Counter/Timer/ScopedTimer/etc. tools are segmented into a BASE STATS and EXPERIMENT STATS section printed to the log on exit.

## 16.5 Mixxx Controls

Nearly every knob, button, or fader you see in Mixxx’s interface is controllable via Mixxx’s «control» system. The control system allows skins, *MIDI* controllers, *HID* controllers and keyboards to control Mixxx via a single interface.

A control is identified by a «group» (which is used for grouping associated controls) and a «key» (the name of the individual control).

For example, the volume fader for Deck 1 is identified by the group `[Channel1]` and key `volume`. Similarly, the volume fader for Sampler 1 is identified by the group `[Sampler1]` and key `volume`.

The group is used to collect all the controls that affect one component of Mixxx into one collection. Some groups have a high overlap of controls in common (e.g. samplers, decks, and the preview deck all share the same control keys).

In addition to controlling Mixxx, the control system can be used to inspect Mixxx’s state. For example, the sample rate of the track loaded in Deck 1 can be accessed via the `[Channel1],track_samplerate` control. You can read the `[Channel13],play` control to determine whether Deck 3 is playing.

The default value range is 0.0 to 1.0, unless otherwise noted. Binary means that it is either “ON” (non-zero) or “OFF” (zero).

---

**Suggerimento:** Discovering Controls used in Skins

You can view the control connected to any part of a skin by running Mixxx with the `--developer` command line option and hovering your mouse cursor over part of the skin. If no tooltip appears, enable tooltips for the Library and Skin in *Options* ▶ *Preferences* ▶ *Interface*.

---

**Suggerimento:** Changing any control from the GUI in Developer Mode

When running Mixxx in Developer Mode (with the `--developer` command line option), you can view and manually set the state of any control in Mixxx by going to *Developer ▶ Developer Tools*.

**Vedi anche:**

See `controlindex` for a full list.

### 16.5.1 ControlPotMeter controls

The following extensions add some features to `ControlPotMeter` controls (volume, *crossfader*, ...). Use in conjunction with `[ChannelN]`, `[SamplerN]`, `[Master]`, ... groups.

| Control Suffix              | Description, example   |
|-----------------------------|--|
| <code>_up</code>            | Increases the value, e.g. <code>[ChannelN], rate_perm_up</code> sets the speed one step higher (4 % default)                 |
| <code>_down</code>          | Decreases the value, sets the speed one step lower (4 % default)   |
| <code>_up_small</code>      | Increases the value by smaller step, sets the speed one small step higher (1 % default)                                      |
| <code>_down_small</code>    | Decreases the value by smaller step, sets the speed one small step lower (1 % default)                                       |
| <code>_set_one</code>       | Sets the value to 1.0, sets the channel volume to full   |
| <code>_set_minus_one</code> | Sets the value to -1.0, sets the channel volume to zero  |
| <code>_set_default</code>   | Input: sets the control to its default, return to default waveform zoom level  |
| <code>_set_default</code>   | Output: set to 1.0 if the control is at its default, light up the pitch fader center indicator                               |
| <code>_set_zero</code>      | Sets the value to 0.0, put the crossfader in the middle again  |
| <code>_toggle</code>        | Sets the value to 0.0 if the value was > 0.0, and to 1.0 if the value was 0.0, will cut off/on a track while you're playing  |
| <code>_minus_toggle</code>  | Sets the value to -1.0 if the value was > -1.0, and to 1.0 if the value was -1.0, can tilt the crossfader from left to right |

These controls can be used in JavaScript files like this:

```
// This won't work:
engine.setValue(group, "pitch_up_small", 1.0);

// Use this instead:
script.triggerControl(group, "pitch_up_small", 50);
```

To use `*_toggle` the respective shortcut for scripts is:

```
script.toggleControl(group, "keylock_toggle", 100);
```

### 16.5.2 The [Master] group

The `[Master]` group generally corresponds to controls that affect the mixing engine. This will bear some similarity to what you will find on a DJ mixer (e.g. *crossfader* controls, headphone cueing controls, etc.).

**[Master]audio\_latency\_usage**

Reflects fraction of *latency*, given by the audio buffer size, spend for audio processing inside Mixxx. At value near 25 % there is a high risk of buffer underflows

This is a *ControlPotMeter control*.

**Range** 0 .. 25 %

**Feedback** latency meter

Nuovo nella versione 2.0.0.

**[Master]audio\_latency\_overload**

Indicates a buffer under or over-flow. Resets after 500 ms

This is a *ControlPotMeter control*.

**Range** binary

**Feedback** Overload indicator

Nuovo nella versione 2.0.0.

**[Master]audio\_latency\_overload\_count**

Counts buffer over and under-flows. Max one per 500 ms

**Range** 0 .. n

**Feedback** Counter in hardware preferences

Nuovo nella versione 2.0.0.

**[Master]balance**

Adjusts the left/right channel balance on the Master output.

This is a *ControlPotMeter control*.

**Range** -1.0..1.0

**Feedback** Center Balance knob

**[Master]booth\_enabled**

Indicates whether a Booth output is configured in the *Sound Hardware Preferences*.

**Range** binary

**Feedback** Booth gain knob shown or hidden

Nuovo nella versione 2.1.0.

**[Master]booth\_gain**

Adjusts the gain of the Booth output.

This is a *ControlPotMeter control*.

**Range** 0.0...1.0...5.0

**Feedback** Booth gain knob

Nuovo nella versione 2.1.0.

**[Master]crossfader**

Adjusts the *crossfader* between players/decks (-1.0 is all the way left).

This is a *ControlPotMeter control*.

**Range** -1.0..1.0

**Feedback** Crossfader slider

**[Master]crossfader\_down**

Moves the *crossfader* left by 1/10th.

**Range** binary

**Feedback** Crossfader slider

**[Master]crossfader\_down\_small**

Moves the *crossfader* left by 1/100th.

**Range** binary

**Feedback** Crossfader slider

Nuovo nella versione 1.10.0.

**[Master] crossfader\_up**

Moves the *crossfader* right by 1/10th.

**Range** binary

**Feedback** Crossfader slider

**[Master] crossfader\_up\_small**

Moves the *crossfader* right by 1/100th.

**Range** binary

**Feedback** Crossfader slider

Nuovo nella versione 1.10.0.

**[Master] duckStrength**

Microphone ducking strength

This is a *ControlPotMeter control*.

**Range** 0.0..1.0

**Feedback** Strength knob

Nuovo nella versione 2.0.0.

**[Master] enabled**

Indicator that the master mix is processed.

**Range** binary

**Feedback** None

Nuovo nella versione 2.0.0.

**[Master] gain**

Adjusts the gain for the master output as well as recording and broadcasting signal.

This is a *ControlPotMeter control*.

**Range** 0.0..1.0..5.0

**Feedback** Master volume knob

Nuovo nella versione 2.0.0.

**[Master] headEnabled**

Indicator that the headphone mix is processed.

**Range** binary

**Feedback** None

Nuovo nella versione 2.0.0.

**[Master] headGain**

Adjusts the headphone output gain.

This is a *ControlPotMeter control*.

**Range** 0.0..1.0..5.0

**Feedback** Headphone volume knob

Nuovo nella versione 2.0.0.

**[Master]headMix**

Adjusts the cue/main mix in the headphone output.

This is a *ControlPotMeter control*.

**Range** default

**Feedback** Pre/Main knob

**[Master]headSplit**

Splits headphone stereo cueing into right (master mono) and left (*PFL* mono).

**Range** binary

**Feedback** Split Cue button

Nuovo nella versione 2.0.0.

**[Master]latency**

*Latency* setting (sound buffer size) in milliseconds (default 64).

**Range**  $\geq 0$  (absolute value)

**Feedback** Latency slider in the prefs

**[Master]maximize\_library**

Toggle maximized view of library.

**Range** binary

**Feedback** Toggle maximized view of library

Nuovo nella versione 2.0.0.

**[Master]num\_decks**

The number of decks currently enabled.

**Range** integer

**Feedback** None

Nuovo nella versione 1.9.0.

**[Master]num\_effectsavailable**

The number of available effects that can be selected in an effect slot.

**Range** integer, read-only

**Feedback** None

Nuovo nella versione 2.1.0.

**[Master]num\_samplers**

The number of samplers currently enabled.

**Range** integer

**Feedback** None

Nuovo nella versione 1.9.0.

**[Master]num\_preview\_decks**

The number of preview decks currently enabled.

**Range** integer



**Feedback** None

Nuovo nella versione 1.11.0.

**[Master]PeakIndicator**

Indicates when the signal is clipping (too loud for the hardware and is being distorted) (composite).

This is a *ControlPotMeter control*.

**Range** binary

**Feedback** Clip light (mono)

**[Master]PeakIndicatorL**

Indicates when the signal is clipping (too loud for the hardware and is being distorted) for the left channel.

This is a *ControlPotMeter control*.

**Range** binary

**Feedback** Clip light (left)

**[Master]PeakIndicatorR**

Indicates when the signal is clipping (too loud for the hardware and is being distorted) for the right channel.

This is a *ControlPotMeter control*.

**Range** binary

**Feedback** Clip light (right)

**[Master]samplerate**

The current output sample rate (default: 44100 Hz).

**Range** absolute value (in Hz)

**Feedback** None

**[Master]talkoverDucking**

Toggle microphone ducking mode (OFF, AUTO, MANUAL)

**Range** FIXME

**Feedback** Ducking mode button

Nuovo nella versione 2.0.0.

**[Master]VuMeter**

Outputs the current instantaneous master volume (composite).

This is a *ControlPotMeter control*.

**Range** default

**Feedback** Master meter (mono)

**[Master]VuMeterL**

Outputs the current instantaneous master volume for the left channel.

This is a *ControlPotMeter control*.

**Range** default

**Feedback** Master meter L

**[Master]VuMeterR**

Outputs the current instantaneous master volume for the right channel.

This is a *ControlPotMeter control*.

**Range** default

**Feedback** Master meter R

**[Master]headVolume**

Adjust headphone volume.

**Range** 0.0..1.0..5.0

**Feedback** Headphone Gain knob

Deprecato dalla versione 2.0.0: Use *[Master], headGain* instead.

**[Master]volume**

Adjust master volume.

**Range** 0.0..1.0..5.0

**Feedback** Master Gain knob

Deprecato dalla versione 2.0.0: Use *[Master], gain* instead.

### 16.5.3 Decks, Preview Decks and Samplers

Each deck in Mixxx corresponds to a *[ChannelN]* group. Whenever you see *[ChannelN]*, think «Deck N». N can range from 1 to the number of active decks in Mixxx.

Preview decks and Sample decks («samplers») in Mixxx are identical to regular decks, they simply have a different purpose (previewing tracks or playing samples, respectively). Any control listed above for *[ChannelN]* will work for a samplers and preview decks, just replace *[ChannelN]* with *[PreviewDeckN]* or *[SamplerN]*.

**Vedi anche:**

There are some *additional global controls for samplers*.

**[ChannelN]back**

**[PreviewDeckN]back**

**[SamplerN]back**

Fast rewind (REW)

**Range** binary

**Feedback** << button

**[ChannelN]beat\_active**

**[PreviewDeckN]beat\_active**

**[SamplerN]beat\_active**

Indicates whether the player is currently positioned within 50 milliseconds of a beat or not. This can be used to make controller LEDs blink on every beat.

**Range** binary

**Feedback** None

Nuovo nella versione 1.10.0.

**[ChannelN]beat\_closest**

**[PreviewDeckN]beat\_closest**

**[SamplerN]beat\_closest**

Its value is set to the sample position of the closest beat of the active beat and is used for updating the beat LEDs.  
:range: -1, 0.0, real-valued :feedback: None

**[ChannelN]beat\_distance**

[PreviewDeckN]beat\_distance

[SamplerN]beat\_distance

Outputs the relative position of the play marker in the section between the the previous and next beat marker.  
:range: 0.0 - 1.0, real-valued :feedback: None

[ChannelN]beat\_jump

[PreviewDeckN]beat\_jump

[SamplerN]beat\_jump

Jump forward by *beatjump\_size* (positive) or backward by *beatjump\_size* (negative). If a loop is active, the loop is moved by *beatjump\_size*.

**Range** real number, -1, 0, 1

**Feedback** Player jumps forward or backward by X beats.

Nuovo nella versione 2.0.0.

[ChannelN]beat\_jump\_size

[PreviewDeckN]beat\_jump\_size

[SamplerN]beat\_jump\_size

Set the number of beats to jump with *beatjump\_forward/beatjump\_backward*.

**Range** positive real number

**Feedback** Beatjump size spinbox

Nuovo nella versione 2.1.0.

[ChannelN]beat\_jump\_forward

[PreviewDeckN]beat\_jump\_forward

[SamplerN]beat\_jump\_forward

Jump forward by *beatjump\_size*. If a loop is active, the loop is moved forward by X beats.

**Range** binary

**Feedback** Player jumps forward by *beatjump\_size*.

Nuovo nella versione 2.1.0.

[ChannelN]beat\_jump\_backward

[PreviewDeckN]beat\_jump\_backward

[SamplerN]beat\_jump\_backward

Jump backward by *beatjump\_size*. If a loop is active, the loop is moved backward by X beats.

**Range** binary

**Feedback** Player jumps backward by *beatjump\_size*.

Nuovo nella versione 2.1.0.

[ChannelN]beat\_jump\_X\_forward

[PreviewDeckN]beat\_jump\_X\_forward

[SamplerN]beat\_jump\_X\_forward

Jump forward by X beats. A control exists for X = 0.03125, 0.0625, 0.125, 0.25, 0.5, 1, 2, 4, 8, 16, 32, 64. If a loop is active, the loop is moved forward by X betas.

**Range** binary

**Feedback** Player jumps forward by X beats.

Nuovo nella versione 2.0.0.

[ChannelN]beat\_jump\_X\_backward

[PreviewDeckN]beat\_jump\_X\_backward

**[SamplerN]beatjump\_X\_backward**

Jump backward by X beats. A control exists for X = 0.03125, 0.0625, 0.125, 0.25, 0.5, 1, 2, 4, 8, 16, 32, 64. If a loop is active, the loop is moved backward by X beats.

**Range** binary

**Feedback** Player jumps backward by X beats.

Nuovo nella versione 2.0.0.

**[ChannelN]beatloop\_activate**

**[PreviewDeckN]beatloop\_activate**

**[SamplerN]beatloop\_activate**

Set a loop that is *beatloop\_size* beats long and enables the loop

**Range** binary

**Feedback** A loop is shown over *beatloop\_size* beats

Nuovo nella versione 2.1.0.

**[ChannelN]beatloop\_X\_activate**

**[PreviewDeckN]beatloop\_X\_activate**

**[SamplerN]beatloop\_X\_activate**

Activates a loop over X beats. A control exists for X = 0.03125, 0.0625, 0.125, 0.25, 0.5, 1, 2, 4, 8, 16, 32, 64

**Range** binary

**Feedback** A loop is shown over X beats.

Nuovo nella versione 1.10.0.

**[ChannelN]beatloop\_size**

**[PreviewDeckN]beatloop\_size**

**[SamplerN]beatloop\_size**

Set the length of the loop in beats that will get set with *beatloop\_activate* and *beatlooproll\_activate*. Changing this will resize an existing loop if the length of the loop matches *beatloop\_size*.

**Range** positive real number

**Feedback** Beatloop size spinbox and possibly loop section on waveform

Nuovo nella versione 2.1.0.

**[ChannelN]beatloop\_X\_toggle**

**[PreviewDeckN]beatloop\_X\_toggle**

**[SamplerN]beatloop\_X\_toggle**

Toggles a loop over X beats. A control exists for X = 0.03125, 0.0625, 0.125, 0.25, 0.5, 1, 2, 4, 8, 16, 32, 64

**Range** binary

**Feedback** A loop is shown over X beats.

Nuovo nella versione 1.10.0.

**[ChannelN]beatloop\_X\_enabled**

**[PreviewDeckN]beatloop\_X\_enabled**

**[SamplerN]beatloop\_X\_enabled**

1 if beatloop X is enabled, 0 if not.

**Range** binary

**Feedback** Beatloop X button in skin is lit.

Nuovo nella versione 1.10.0.

[ChannelN]beatlooproll\_activate  
 [PreviewDeckN]beatlooproll\_activate  
 [SamplerN]beatlooproll\_activate

Activates a rolling loop over *beatloop\_size* beats. Once disabled, playback will resume where the track would have been if it had not entered the loop.

**Range** binary

**Feedback** A loop overlay is shown over *beatloop\_size* beats on waveform.

Nuovo nella versione 2.1.0.

[ChannelN]beatlooproll\_X\_activate  
 [PreviewDeckN]beatlooproll\_X\_activate  
 [SamplerN]beatlooproll\_X\_activate

Activates a rolling loop over X beats. Once disabled, playback will resume where the track would have been if it had not entered the loop. A control exists for X = 0.03125, 0.0625, 0.125, 0.25, 0.5, 1, 2, 4, 8, 16, 32, 64

**Range** binary

**Feedback** Beatloop X button in skin is lit. A loop overlay is shown over X beats on waveform.

Nuovo nella versione 1.11.0.

[ChannelN]beats\_adjust\_faster  
 [PreviewDeckN]beats\_adjust\_faster  
 [SamplerN]beats\_adjust\_faster

Adjust the average *BPM* up by +0.01

**Range** binary

**Feedback** The *beatgrid* lines move closer to each other.

Nuovo nella versione 2.0.0.

[ChannelN]beats\_adjust\_slower  
 [PreviewDeckN]beats\_adjust\_slower  
 [SamplerN]beats\_adjust\_slower

Adjust the average *BPM* down by -0.01.

**Range** binary

**Feedback** The *beatgrid* lines move further apart from each other.

Nuovo nella versione 2.0.0.

[ChannelN]beats\_translate\_curpos  
 [PreviewDeckN]beats\_translate\_curpos  
 [SamplerN]beats\_translate\_curpos

Adjust *beatgrid* so closest beat is aligned with the current playposition.

**Range** binary

**Feedback** The beatgrid moves to align with current playposition.

Nuovo nella versione 1.10.0.

[ChannelN]beats\_translate\_match\_alignment  
 [PreviewDeckN]beats\_translate\_match\_alignment  
 [SamplerN]beats\_translate\_match\_alignment

Adjust *beatgrid* to match another playing deck.

**Range** binary

**Feedback** Instead of *syncing* the beatgrid to the current playposition, sync the beatgrid so the nearest beat lines up with the other track's nearest beat.

Nuovo nella versione 2.0.0.

[ChannelN]beats\_translate\_earlier  
 [PreviewDeckN]beats\_translate\_earlier  
 [SamplerN]beats\_translate\_earlier

Move *beatgrid* to an earlier position.

**Range** binary

**Feedback** The beatgrid moves left by a small amount.

Nuovo nella versione 2.0.0.

[ChannelN]beats\_translate\_later  
 [PreviewDeckN]beats\_translate\_later  
 [SamplerN]beats\_translate\_later

Move *beatgrid* to a later position.

**Range** binary

**Feedback** The beatgrid moves right by a small amount.

Nuovo nella versione 2.0.0.

[ChannelN]beat\_sync  
 [PreviewDeckN]beat\_sync  
 [SamplerN]beat\_sync

*Syncs* the *tempo* and phase (depending on quantize) to that of the other track (if *BPM* is detected on both).

**range** binary

**feedback** The *Sync* button flashes and the *tempo* slider snaps to the appropriate value.

Cambiato nella versione 1.10.0.

[ChannelN]beat\_sync\_phase  
 [PreviewDeckN]beat\_sync\_phase  
 [SamplerN]beat\_sync\_phase

*Syncs* the *phase* to that of the other track (if *BPM* is detected on both).

**Range** binary

**Feedback** The *Sync* button flashes and the *tempo* slider snap to the appropriate value.

Nuovo nella versione 1.10.0.

[ChannelN]beatsync\_tempo  
 [PreviewDeckN]beatsync\_tempo  
 [SamplerN]beatsync\_tempo

*Syncs* the *tempo* to that of the other track (if *BPM* is detected on both).

**Range** binary

**Feedback** The *Sync* button flashes and the *tempo* slider snaps to the appropriate value.

Nuovo nella versione 1.10.0.

[ChannelN]bpm  
 [PreviewDeckN]bpm  
 [SamplerN]bpm

Reflects the perceived (rate-adjusted) *BPM* of the loaded file.

This is a *ControlPotMeter control*.

**Range** real-valued

**Feedback** *BPM* value display

Cambiato nella versione 1.10.0.

**[ChannelN] bpm\_tap**

**[PreviewDeckN] bpm\_tap**

**[SamplerN] bpm\_tap**

When tapped repeatedly, adjusts the *BPM* of the track on the deck (not the tempo slider!) to match the taps.

---

**Nota:** If you want to change the *rate* of the deck use `script.bpm.tapButton(deck)` in your controller mapping instead.

---

**Range** binary

**Feedback** *BPM* value display (playback speed doesn't change)

Nuovo nella versione 1.9.2.

**[ChannelN] CloneFromDeck**

**[PreviewDeckN] CloneFromDeck**

**[SamplerN] CloneFromDeck**

Clone the given deck number, copying the play state, position, rate, and key. If 0 or a negative number is given, Mixxx will attempt to select the first playing deck as the source for the clone.

**Range** integer between 1 and `[Master], num_decks` (inclusive)

**Feedback** The channel will start playing at the rate and position of the source deck.

Nuovo nella versione 2.3.0.

**[ChannelN] CloneFromSampler**

**[PreviewDeckN] CloneFromSampler**

**[SamplerN] CloneFromSampler**

Clone the given sampler number, copying the play state, position, rate, and key.

**Range** integer between 1 and `[Master], num_samplers` (inclusive)

**Feedback** The channel will start playing at the rate and position of the source deck.

Nuovo nella versione 2.3.0.

**[ChannelN] cue\_cdj**

**[PreviewDeckN] cue\_cdj**

**[SamplerN] cue\_cdj**

Represents a *Cue* button that is always in *CDJ* mode.

**Range** binary

**Feedback** None

Nuovo nella versione 1.10.0.

**[ChannelN] cue\_clear**

**[PreviewDeckN] cue\_clear**

**[SamplerN] cue\_clear**

Deletes the already set cue point and sets `[ChannelN], cue_point` to -1.

**Range** binary

**Feedback** None

[ChannelN] cue\_goto

[PreviewDeckN] cue\_goto

[SamplerN] cue\_goto

If the cue point is set, recalls the cue point.

**Range** binary

**Feedback** Player may change position

[ChannelN] cue\_default

[PreviewDeckN] cue\_default

[SamplerN] cue\_default

In *CDJ* mode, when playing, returns to the *cue point* and pauses. If stopped, sets a cue point at the current location.

If stopped and at a cue point, plays from that point until released (set to 0.)

**Range** binary

**Feedback** Cue button

[ChannelN] cue\_gotoandplay

[PreviewDeckN] cue\_gotoandplay

[SamplerN] cue\_gotoandplay

If the *cue point* is set, seeks the player to it and starts playback.

**Range** binary

**Feedback** Player may change position and start playing.

Nuovo nella versione 1.11.0.

[ChannelN] cue\_gotoandstop

[PreviewDeckN] cue\_gotoandstop

[SamplerN] cue\_gotoandstop

If the *cue point* is set, seeks the player to it and stops.

**Range** binary

**Feedback** Player may change position.

Nuovo nella versione 1.11.0.

[ChannelN] cue\_indicator

[PreviewDeckN] cue\_indicator

[SamplerN] cue\_indicator

Indicates the blinking pattern of the *CUE* button (i.e. 1.0 if the button is illuminated, 0.0 otherwise), depending on the chosen *cue mode*.

**Range** binary

**Feedback** Cue button

Nuovo nella versione 2.0.0.

[ChannelN] cue\_mode

[PreviewDeckN] cue\_mode

[SamplerN] cue\_mode

Represents the currently chosen *cue mode*.

**Range**



|       |                          |
|-------|--------------------------|
| Value | compatible hardware      |
| 0.0   | Mixxx mode (default)     |
| 1.0   | Pioneer mode             |
| 2.0   | Denon mode               |
| 3.0   | Numark mode              |
| 4.0   | Mixxx mode (no blinking) |
| 5.0   | CUP (Cue + Play) mode    |

**Feedback** None

**[ChannelN] cue\_play**  
**[PreviewDeckN] cue\_play**  
**[SamplerN] cue\_play**

Go to *cue point* and play after release (CUP button behavior). If stopped, sets a cue point at the current location.

**Range** binary

**Feedback** None

Nuovo nella versione 2.1.0.

**[ChannelN] cue\_point**  
**[PreviewDeckN] cue\_point**  
**[SamplerN] cue\_point**

The current position of the *cue point* in samples.

**Range** absolute value

**Feedback** Cue point marker

**[ChannelN] cue\_preview**  
**[PreviewDeckN] cue\_preview**  
**[SamplerN] cue\_preview**

Plays from the current *cue point*.

**Range** binary

**Feedback** Cue button lights and waveform moves

**[ChannelN] cue\_set**  
**[PreviewDeckN] cue\_set**  
**[SamplerN] cue\_set**

Sets a *cue point* at the current location.

**Range** binary

**Feedback** Cue mark appears on the waveform

**[ChannelN] cue\_simple**  
**[PreviewDeckN] cue\_simple**  
**[SamplerN] cue\_simple**

If the player is not playing, set the *cue point* at the current location otherwise seek to the cue point.

**Range** binary

**Feedback** Cue button

**[ChannelN] duration**  
**[PreviewDeckN] duration**  
**[SamplerN] duration**

Outputs the length of the current song in seconds

**Range** absolute value

**Feedback** None

[ChannelN] eject

[PreviewDeckN] eject

[SamplerN] eject

Eject currently loaded track

**Range** binary

**Feedback** Eject button is lit. Be sure to set back to 0 with scripts so the button does not stay lit.

Nuovo nella versione 1.9.0.

[ChannelN] end

[PreviewDeckN] end

[SamplerN] end

Jump to end of track

**Range** binary

**Feedback** Track jumps to end

[ChannelN] end\_of\_track

[PreviewDeckN] end\_of\_track

[SamplerN] end\_of\_track

Switches to 1 if the play position is within the end range defined in *Preferences* ▶ *Waveforms* ▶ *End of track warning*.

**Range** binary, read-only

**Feedback** Waveform and Overview widgets show a flashing border

[ChannelN] file\_bpm

[PreviewDeckN] file\_bpm

[SamplerN] file\_bpm

The detected *BPM* of the loaded track.

**Range** positive value, read-only

**Feedback** None

[ChannelN] file\_key

[PreviewDeckN] file\_key

[SamplerN] file\_key

The detected key of the loaded track.

**Range** ?, read-only

**Feedback** None

Nuovo nella versione 2.0.0.

[ChannelN] fwd

[PreviewDeckN] fwd

[SamplerN] fwd

Fast forward (FF)

**Range** binary

**Feedback** > button

[ChannelN] hotcue\_X\_activate

[PreviewDeckN] hotcue\_X\_activate

**[SamplerN]hotcue\_X\_activate**

If *hotcue* X is not set, this sets a hotcue at the current play position and saves it to hotcue slot X.

If hotcue X is set, the player seeks to hotcue X's position. Setting the control to 1 when the track is currently not playing (i.e. *play* is set to 0) will start hotcue previewing. After resetting the control to 0, playback will usually be stopped and the player will seek to the hotcue position. If *play* is set to 1 while previewing is active, the playback will continue and no seek occurs.

**Range** binary

**Feedback** Player may change position. Hotcue X marker may change on waveform.

Nuovo nella versione 1.8.0.

**[ChannelN]hotcue\_X\_clear**

**[PreviewDeckN]hotcue\_X\_clear**

**[SamplerN]hotcue\_X\_clear**

If *hotcue* X is set, clears its hotcue status.

**Range** binary

**Feedback** Hotcue X marker changes on waveform.

Nuovo nella versione 1.8.0.

**[ChannelN]hotcue\_X\_color**

**[PreviewDeckN]hotcue\_X\_color**

**[SamplerN]hotcue\_X\_color**

Color of *hotcue* X or -1 if the hotcue is not set.

**Range** 3-Byte *RGB* color code (or -1)

**Feedback** Color of Hotcue X button and waveform marker changes.

Nuovo nella versione 2.3.0.

**[ChannelN]hotcue\_X\_enabled**

**[PreviewDeckN]hotcue\_X\_enabled**

**[SamplerN]hotcue\_X\_enabled**

Indicates if *hotcue* slot X is set. The value is 1 if the hotcue is set (position is not -1), 0 otherwise.

**Range** binary, read-only

Nuovo nella versione 1.8.0.

**[ChannelN]hotcue\_X\_goto**

**[PreviewDeckN]hotcue\_X\_goto**

**[SamplerN]hotcue\_X\_goto**

If *hotcue* X is set, seeks the player to hotcue X's position.

**Range** binary

**Feedback** Player may change position.

Nuovo nella versione 1.8.0.

**[ChannelN]hotcue\_X\_gotoandplay**

**[PreviewDeckN]hotcue\_X\_gotoandplay**

**[SamplerN]hotcue\_X\_gotoandplay**

If *hotcue* X is set, seeks the player to hotcue X's position and starts playback.

**Range** binary

**Feedback** Player may change position.

Nuovo nella versione 1.11.0.

[ChannelN]hotcue\_X\_gotoandstop  
 [PreviewDeckN]hotcue\_X\_gotoandstop  
 [SamplerN]hotcue\_X\_gotoandstop

If *hotcue* X is set, seeks the player to hotcue X's position and stops.

**Range** binary

**Feedback** Player may change position.

Nuovo nella versione 1.8.0.

[ChannelN]hotcue\_X\_position  
 [PreviewDeckN]hotcue\_X\_position  
 [SamplerN]hotcue\_X\_position

The position of *hotcue* X in samples, -1 if not set.

**Range** positive integer

**Feedback** Hotcue X marker changes on waveform.

Nuovo nella versione 1.8.0.

[ChannelN]hotcue\_X\_set  
 [PreviewDeckN]hotcue\_X\_set  
 [SamplerN]hotcue\_X\_set

Set *hotcue* X to the current play position. If hotcue X was previously set, clears its hotcue status.

**Range** binary

**Feedback** Hotcue X marker changes on waveform.

Nuovo nella versione 1.8.0.

[ChannelN]hotcue\_focus  
 [PreviewDeckN]hotcue\_focus  
 [SamplerN]hotcue\_focus

Contains the number of the most recently used *hotcue* (or -1 if no hotcue was used).

**Range** positive integer (or -1)

**Feedback** None

Nuovo nella versione 2.3.0.

[ChannelN]hotcue\_focus\_color\_prev  
 [PreviewDeckN]hotcue\_focus\_color\_prev  
 [SamplerN]hotcue\_focus\_color\_prev

If there is a focused *hotcue*, sets its color to the previous color in the palette.

**Range** binary

**Feedback** Color of focused hotcue button and waveform marker changes.

Nuovo nella versione 2.3.0.

[ChannelN]hotcue\_focus\_color\_next  
 [PreviewDeckN]hotcue\_focus\_color\_next  
 [SamplerN]hotcue\_focus\_color\_next

If there is a focused *hotcue*, sets its color to the next color in the palette.

**Range** binary

**Feedback** Color of focused hotcue button and waveform marker changes.

Nuovo nella versione 2.3.0.

**[ChannelN]intro\_end\_activate**  
**[PreviewDeckN]intro\_end\_activate**  
**[SamplerN]intro\_end\_activate**

If the intro end cue is set, seeks the player to the intro end position. If the intro end is not set, sets the intro end to the current play position.

**Range** binary

**Feedback** Player may change position. Intro end marker may change on waveform.

Nuovo nella versione 2.3.0.

**[ChannelN]intro\_end\_clear**  
**[PreviewDeckN]intro\_end\_clear**  
**[SamplerN]intro\_end\_clear**

If the intro end cue is set, clears its status.

**Range** binary

**Feedback** Intro end marker changes on waveform.

Nuovo nella versione 2.3.0.

**[ChannelN]intro\_end\_enabled**  
**[PreviewDeckN]intro\_end\_enabled**  
**[SamplerN]intro\_end\_enabled**

1 if intro end cue is set, (position is not -1), 0 otherwise.

**Range** binary, read-only

**Feedback** Intro end button lights up.

Nuovo nella versione 2.3.0.

**[ChannelN]intro\_end\_position**  
**[PreviewDeckN]intro\_end\_position**  
**[SamplerN]intro\_end\_position**

The position of the intro end in samples, -1 if not set.

**Range** positive integer

**Feedback** Intro end marker changes on waveform.

Nuovo nella versione 2.3.0.

**[ChannelN]intro\_end\_set**  
**[PreviewDeckN]intro\_end\_set**  
**[SamplerN]intro\_end\_set**

Set intro end to the current play position. If intro end was previously set, it is moved to the new position.

**Range** binary

**Feedback** Intro end marker changes on waveform.

Nuovo nella versione 2.3.0.

**[ChannelN]intro\_start\_activate**  
**[PreviewDeckN]intro\_start\_activate**  
**[SamplerN]intro\_start\_activate**

If the intro start cue is set, seeks the player to the intro start position. If the intro start is not set, sets the intro start to the current play position.

**Range** binary

**Feedback** Player may change position. Intro start marker may change on waveform.

Nuovo nella versione 2.3.0.

**[ChannelN] intro\_start\_clear**  
**[PreviewDeckN] intro\_start\_clear**  
**[SamplerN] intro\_start\_clear**

If the intro start cue is set, clears its status.

**Range** binary

**Feedback** Intro start marker changes on waveform.

Nuovo nella versione 2.3.0.

**[ChannelN] intro\_start\_enabled**  
**[PreviewDeckN] intro\_start\_enabled**  
**[SamplerN] intro\_start\_enabled**

1 if intro start cue is set, (position is not -1), 0 otherwise.

**Range** binary, read-only

**Feedback** Intro start button lights up.

Nuovo nella versione 2.3.0.

**[ChannelN] intro\_start\_position**  
**[PreviewDeckN] intro\_start\_position**  
**[SamplerN] intro\_start\_position**

The position of the intro start in samples, -1 if not set.

**Range** positive integer

**Feedback** Intro start marker changes on waveform.

Nuovo nella versione 2.3.0.

**[ChannelN] intro\_start\_set**  
**[PreviewDeckN] intro\_start\_set**  
**[SamplerN] intro\_start\_set**

Set intro start to the current play position. If intro start was previously set, it is moved to the new position.

**Range** binary

**Feedback** Intro start marker changes on waveform.

Nuovo nella versione 2.3.0.

**[ChannelN] key**  
**[PreviewDeckN] key**  
**[SamplerN] key**

Current key of the track

**Range**

| Value | OpenKey | Lancelot | Traditional              |
|-------|---------|----------|--------------------------|
| 1     | 1d      | 8b       | C                        |
| 2     | 8d      | 3b       | D $\flat$                |
| 3     | 3d      | 10b      | D                        |
| 4     | 10d     | 5b       | E $\flat$                |
| 5     | 5d      | 12b      | E                        |
| 6     | 12d     | 7b       | F                        |
| 7     | 7d      | 2b       | F $\sharp$ /G $\flat$    |
| 8     | 2d      | 9b       | G                        |
| 9     | 9d      | 4b       | A $\flat$                |
| 10    | 4d      | 11b      | A                        |
| 11    | 11d     | 6b       | B $\flat$                |
| 12    | 6d      | 1b       | B                        |
| 13    | 10m     | 5a       | Cm                       |
| 14    | 5m      | 12a      | C $\sharp$ m             |
| 15    | 12m     | 7a       | Dm                       |
| 16    | 7m      | 2a       | D $\sharp$ m/E $\flat$ m |
| 17    | 2m      | 9a       | Em                       |
| 18    | 9m      | 4a       | Fm                       |
| 19    | 4m      | 11a      | F $\sharp$ m             |
| 20    | 11m     | 6a       | Gm                       |
| 21    | 6m      | 1a       | G $\sharp$ m             |
| 22    | 1m      | 8a       | Am                       |
| 23    | 8m      | 3a       | B $\flat$ m              |
| 24    | 3m      | 10a      | Bm                       |

Nuovo nella versione 2.0.0.

**[ChannelN] keylock**

**[PreviewDeckN] keylock**

**[SamplerN] keylock**

Enable key-lock for the specified deck (rate changes only affect tempo, not key)

**Range** binary

**Feedback** key-lock button activates

Nuovo nella versione 1.9.0.

**[ChannelN] LoadSelectedTrack**

**[PreviewDeckN] LoadSelectedTrack**

**[SamplerN] LoadSelectedTrack**

Loads the currently highlighted track into the deck

**Range** binary

**Feedback** Track name & waveform change

**[ChannelN] LoadSelectedTrackAndPlay**

**[PreviewDeckN] LoadSelectedTrackAndPlay**

**[SamplerN] LoadSelectedTrackAndPlay**

Loads the currently highlighted track into the deck and starts playing

**Range** binary

**Feedback** Track name & waveform change & Play/pause button

Nuovo nella versione 1.11.0.

[ChannelN] local\_bpm

[PreviewDeckN] local\_bpm

[SamplerN] local\_bpm

Reflects the average bpm around the current play position of the loaded file.

**Range** positive value

**Feedback** None

[ChannelN] loop\_double

[PreviewDeckN] loop\_double

[SamplerN] loop\_double

Doubles *beatloop\_size*. If *beatloop\_size* equals the size of the loop, the loop is resized.

**Range** binary

**Feedback** Beatloop size spinbox changes

Nuovo nella versione 1.10.0.

Cambiato nella versione 2.1.0.

[ChannelN] loop\_enabled

[PreviewDeckN] loop\_enabled

[SamplerN] loop\_enabled

Indicates whether or not a loop is enabled.

**Range** binary, read-only

**Feedback** Loop in waveform is active.

Nuovo nella versione 1.8.0.

[ChannelN] loop\_end\_position

[PreviewDeckN] loop\_end\_position

[SamplerN] loop\_end\_position

The player loop-out position in samples, -1 if not set.

**Range** positive integer

**Feedback** Loop-out marker shows on waveform.

Nuovo nella versione 1.8.0.

[ChannelN] loop\_half

[PreviewDeckN] loop\_half

[SamplerN] loop\_half

Halves *beatloop\_size*. If *beatloop\_size* equals the size of the loop, the loop is resized.

**Range** binary

**Feedback** Beatloop size spinbox changes

Nuovo nella versione 1.10.0.

Cambiato nella versione 2.1.0.

[ChannelN] loop\_in

[PreviewDeckN] loop\_in

[SamplerN] loop\_in

If loop is disabled, sets the player loop in position to the current play position. If loop is enabled, press and hold to move loop in position to the current play position. If quantize is enabled, *beatloop\_size* will be updated to reflect the new loop size.

**Range** binary



**Feedback** Loop-in marker changes on waveform.

Nuovo nella versione 1.8.0.

Cambiato nella versione 2.1.0.

**[ChannelN] loop\_in\_goto**  
**[PreviewDeckN] loop\_in\_goto**  
**[SamplerN] loop\_in\_goto**

Seek to the loop in point.

**Range** binary

**Feedback** Waveform position jumps

Nuovo nella versione 2.1.0.

**[ChannelN] loop\_out**  
**[PreviewDeckN] loop\_out**  
**[SamplerN] loop\_out**

If loop is disabled, sets the player loop out position to the current play position. If loop is enabled, press and hold to move loop out position to the current play position. If quantize is enabled, *beatloop\_size* will be updated to reflect the new loop size.

**Range** binary

**Feedback** Loop-out marker changes on waveform.

Nuovo nella versione 1.8.0.

Cambiato nella versione 2.1.0.

**[ChannelN] loop\_out\_goto**  
**[PreviewDeckN] loop\_out\_goto**  
**[SamplerN] loop\_out\_goto**

Seek to the loop out point.

**Range** binary

**Feedback** Waveform position jumps

Nuovo nella versione 2.1.0.

**[ChannelN] loop\_move**  
**[PreviewDeckN] loop\_move**  
**[SamplerN] loop\_move**

Move loop forward by X beats (positive) or backward by X beats (negative).

**Range** real number

**Feedback** Loop moves forward or backward by X beats.

Nuovo nella versione 2.0.0.

**[ChannelN] loop\_move\_X\_forward**  
**[PreviewDeckN] loop\_move\_X\_forward**  
**[SamplerN] loop\_move\_X\_forward**

Moves the loop in and out points forward by X beats. A control exists for X = 0.03125, 0.0625, 0.125, 0.25, 0.5, 1, 2, 4, 8, 16, 32, 64

**Range** binary

**Feedback** Loop moves forward by X beats.

Nuovo nella versione 2.0.0.

[ChannelN] loop\_move\_X\_backward  
 [PreviewDeckN] loop\_move\_X\_backward  
 [SamplerN] loop\_move\_X\_backward

Loop moves by X beats. A control exists for X = 0.03125, 0.0625, 0.125, 0.25, 0.5, 1, 2, 4, 8, 16, 32, 64

**Range** binary

**Feedback** Loop moves backward by X beats.

Nuovo nella versione 2.0.0.

[ChannelN] loop\_scale  
 [PreviewDeckN] loop\_scale  
 [SamplerN] loop\_scale

Scale the loop length by the value scale is set to by moving the end marker. *beatloop\_size* is not updated to reflect the change.

**Range** 0.0 - infinity

**Feedback** Loop length is scaled by given amount on waveform.

Nuovo nella versione 1.10.0.

[ChannelN] loop\_start\_position  
 [PreviewDeckN] loop\_start\_position  
 [SamplerN] loop\_start\_position

The player loop-in position in samples, -1 if not set.

**Range** positive integer

**Feedback** Loop-in marker changes on waveform.

Nuovo nella versione 1.8.0.

[ChannelN] orientation  
 [PreviewDeckN] orientation  
 [SamplerN] orientation

Set channel orientation for the *crossfader*.

**Range**

| Value | Meaning                             |
|-------|-------------------------------------|
| 0     | Left side of crossfader             |
| 1     | Center (not affected by crossfader) |
| 2     | Right side of crossfader            |

**Feedback** None

Nuovo nella versione 1.9.0.

[ChannelN] orientation\_center  
 [PreviewDeckN] orientation\_center  
 [SamplerN] orientation\_center  
 [AuxiliaryN] orientation\_center

Assign channel to the center of the *crossfader*.

[ChannelN] orientation\_left  
 [PreviewDeckN] orientation\_left  
 [SamplerN] orientation\_left  
 [AuxiliaryN] orientation\_left

Assign channel to the left side of the *crossfader*.

[ChannelN]orientation\_right  
 [PreviewDeckN]orientation\_right  
 [SamplerN]orientation\_right  
 [AuxiliaryN]orientation\_right

Assign channel to the right side of the *crossfader*.

[ChannelN]outro\_end\_activate  
 [PreviewDeckN]outro\_end\_activate  
 [SamplerN]outro\_end\_activate

If the outro end cue is set, seeks the player to the outro end position. If the outro end is not set, sets the outro end to the current play position.

**Range** binary

**Feedback** Player may change position. Outro end marker may change on waveform.

Nuovo nella versione 2.3.0.

[ChannelN]outro\_end\_clear  
 [PreviewDeckN]outro\_end\_clear  
 [SamplerN]outro\_end\_clear

If the outro end cue is set, clears its status.

**Range** binary

**Feedback** Outro end marker changes on waveform.

Nuovo nella versione 2.3.0.

[ChannelN]outro\_end\_enabled  
 [PreviewDeckN]outro\_end\_enabled  
 [SamplerN]outro\_end\_enabled

1 if outro end cue is set, (position is not -1), 0 otherwise.

**Range** binary, read-only

**Feedback** Outro end button lights up.

Nuovo nella versione 2.3.0.

[ChannelN]outro\_end\_position  
 [PreviewDeckN]outro\_end\_position  
 [SamplerN]outro\_end\_position

The position of the outro end in samples, -1 if not set.

**Range** positive integer

**Feedback** Outro end marker changes on waveform.

Nuovo nella versione 2.3.0.

[ChannelN]outro\_end\_set  
 [PreviewDeckN]outro\_end\_set  
 [SamplerN]outro\_end\_set

Set outro end to the current play position. If outro end was previously set, it is moved to the new position.

**Range** binary

**Feedback** Outro end marker changes on waveform.

Nuovo nella versione 2.3.0.

[ChannelN]outro\_start\_activate  
 [PreviewDeckN]outro\_start\_activate

**[SamplerN] outro\_start\_activate**

If the outro start cue is set, seeks the player to the outro start position. If the outro start is not set, sets the outro start to the current play position.

**Range** binary

**Feedback** Player may change position. Outro start marker may change on waveform.

Nuovo nella versione 2.3.0.

**[ChannelN] outro\_start\_clear**

**[PreviewDeckN] outro\_start\_clear**

**[SamplerN] outro\_start\_clear**

If the outro start cue is set, clears its status.

**Range** binary

**Feedback** Outro start marker changes on waveform.

Nuovo nella versione 2.3.0.

**[ChannelN] outro\_start\_enabled**

**[PreviewDeckN] outro\_start\_enabled**

**[SamplerN] outro\_start\_enabled**

1 if outro start cue is set, (position is not -1), 0 otherwise.

**Range** binary, read-only

**Feedback** Outro start button lights up.

Nuovo nella versione 2.3.0.

**[ChannelN] outro\_start\_position**

**[PreviewDeckN] outro\_start\_position**

**[SamplerN] outro\_start\_position**

The position of the outro start in samples, -1 if not set.

**Range** positive integer

**Feedback** Outro start marker changes on waveform.

Nuovo nella versione 2.3.0.

**[ChannelN] outro\_start\_set**

**[PreviewDeckN] outro\_start\_set**

**[SamplerN] outro\_start\_set**

Set outro start to the current play position. If outro start was previously set, it is moved to the new position.

**Range** binary

**Feedback** Outro start marker changes on waveform.

Nuovo nella versione 2.3.0.

**[ChannelN] passthrough**

**[PreviewDeckN] passthrough**

**[SamplerN] passthrough**

Connects the vinyl control input for vinyl control on that deck to the channel output. Allows to mix external media into DJ sets.

**Range** binary

**Feedback** Passthrough label in the *waveform overview* and passthrough button

Nuovo nella versione 2.0.0.

**[ChannelN]PeakIndicator**  
**[PreviewDeckN]PeakIndicator**  
**[SamplerN]PeakIndicator**

Indicates when the signal is clipping (too loud for the hardware and is being distorted)

This is a *ControlPotMeter control*.

**Range** binary

**Feedback** Clip light

**[ChannelN]PeakIndicatorL**  
**[PreviewDeckN]PeakIndicatorL**  
**[SamplerN]PeakIndicatorL**

Indicates when the signal is clipping (too loud for the hardware and is being distorted) for the left channel

This is a *ControlPotMeter control*.

**Range** binary

**Feedback** Clip light (left)

Nuovo nella versione 2.0.0.

**[ChannelN]PeakIndicatorR**  
**[PreviewDeckN]PeakIndicatorR**  
**[SamplerN]PeakIndicatorR**

Indicates when the signal is clipping (too loud for the hardware and is being distorted) for the right channel

This is a *ControlPotMeter control*.

**Range** binary

**Feedback** Clip light (right)

Nuovo nella versione 2.0.0.

**[ChannelN]pfl**  
**[PreviewDeckN]pfl**  
**[SamplerN]pfl**

Toggles *headphone cueing (PFL)*.

**Range** binary

**Feedback** Headphone button

**[ChannelN]pitch**  
**[PreviewDeckN]pitch**  
**[SamplerN]pitch**

The total adjustment to the track's pitch, including changes from the rate slider if keylock is off as well as *pitch\_adjust*.

---

**Nota:** Do not map this to knobs or sliders on controllers; map *pitch\_adjust* instead.

---

This is a *ControlPotMeter control*.

**Range** -6.0..6.0

**Feedback** Key display

Nuovo nella versione 2.0.0.

**[ChannelN]pitch\_up**

**[PreviewDeckN]pitch\_up**

**[SamplerN]pitch\_up**

Changes the track pitch up one half step, independent of the tempo.

**Range** binary

**Feedback** Key display

Nuovo nella versione 2.0.0.

**[ChannelN]pitch\_down**

**[PreviewDeckN]pitch\_down**

**[SamplerN]pitch\_down**

Changes the track pitch down one half step, independent of the tempo.

**Range** binary

**Feedback** Key display

Nuovo nella versione 2.0.0.

**[ChannelN]pitch\_adjust**

**[PreviewDeckN]pitch\_adjust**

**[SamplerN]pitch\_adjust**

Adjust the pitch in addition to the *tempo* slider pitch.

This is a *ControlPotMeter control*.

**Range** -3.0..3.0

**Feedback** Key display

Nuovo nella versione 2.0.0.

**[ChannelN]play**

**[PreviewDeckN]play**

**[SamplerN]play**

Toggles playing or pausing the track.

The value is set to 1 when the track is playing or when previewing from cue points and when the play command is adopted and track will be played after loading.

**Range** binary

**Feedback** Play/pause button

**[ChannelN]play\_indicator**

**[PreviewDeckN]play\_indicator**

**[SamplerN]play\_indicator**

Provides information to be bound with the a Play/Pause button e.g blinking when play is possible

**Range** binary, read-only

**Feedback** Play/pause button

Nuovo nella versione 2.0.0.

**[ChannelN]play\_latched**

**[PreviewDeckN]play\_latched**

**[SamplerN]play\_latched**

This is set to 1 when the track is playing, but not when previewing (see *play*).

**Range** binary, read-only

**Feedback** Play/pause button

Nuovo nella versione 2.3.0.

**[ChannelN]play\_stutter**  
**[PreviewDeckN]play\_stutter**  
**[SamplerN]play\_stutter**

A play button without pause. Pushing while playing, starts play at *cue point* again (Stutter).

**Range** binary

**Feedback** Play/Stutter button

Nuovo nella versione 2.0.0.

**[ChannelN]playposition**  
**[PreviewDeckN]playposition**  
**[SamplerN]playposition**

Sets the absolute position in the track.

This is a *ControlPotMeter control*.

**Range** -0.14 to 1.14 (0 = beginning -> Midi 14, 1 = end -> Midi 114)

**Feedback** Waveform

**[ChannelN]pregain**  
**[PreviewDeckN]pregain**  
**[SamplerN]pregain**

Adjusts the pre-fader gain of the track (to avoid clipping)

This is a *ControlPotMeter control*.

**Range** 0.0..1.0..4.0

**Feedback** GAIN knob

**[ChannelN]quantize**  
**[PreviewDeckN]quantize**  
**[SamplerN]quantize**

Aligns Hot-cues and Loop In & Out to the next beat from the current position.

**Range** binary

**Feedback** Hot-cues or Loop In/Out markers

Nuovo nella versione 1.10.0.

**[ChannelN]rate**  
**[PreviewDeckN]rate**  
**[SamplerN]rate**

Speed control

This is a *ControlPotMeter control*.

**Range** -1.0..1.0

**Feedback** Speed slider

**[ChannelN]rate\_dir**  
**[PreviewDeckN]rate\_dir**  
**[SamplerN]rate\_dir**

Indicates orientation of speed slider.

**Range** -1 or 1

**[ChannelN]rate\_perm\_down**

[PreviewDeckN] rate\_perm\_down  
 [SamplerN] rate\_perm\_down  
 Sets the speed one step lower (4 % default) lower  
**Range** binary  
**Feedback** Perm down button & Speed slider

[ChannelN] rate\_perm\_down\_small  
 [PreviewDeckN] rate\_perm\_down\_small  
 [SamplerN] rate\_perm\_down\_small  
 Sets the speed one small step lower (1 % default)  
**Range** binary  
**Feedback** Perm down button & Speed slider

[ChannelN] rate\_perm\_up  
 [PreviewDeckN] rate\_perm\_up  
 [SamplerN] rate\_perm\_up  
 Sets the speed one step higher (4 % default)  
**Range** binary  
**Feedback** Perm up button & Speed slider

[ChannelN] rate\_perm\_up\_small  
 [PreviewDeckN] rate\_perm\_up\_small  
 [SamplerN] rate\_perm\_up\_small  
 Sets the speed one small step higher (1 % default)  
**Range** binary  
**Feedback** Perm up button & Speed slider

[ChannelN] rate\_temp\_down  
 [PreviewDeckN] rate\_temp\_down  
 [SamplerN] rate\_temp\_down  
 Holds the speed one step lower while active  
**Range** binary  
**Feedback** Temp down button & Speed slider

[ChannelN] rate\_temp\_down\_small  
 [PreviewDeckN] rate\_temp\_down\_small  
 [SamplerN] rate\_temp\_down\_small  
 Holds the speed one small step lower while active  
**Range** binary  
**Feedback** Temp down button & Speed slider

[ChannelN] rate\_temp\_up  
 [PreviewDeckN] rate\_temp\_up  
 [SamplerN] rate\_temp\_up  
 Holds the speed one step higher while active  
**Range** binary  
**Feedback** Temp up button & Speed slider

[ChannelN] rate\_temp\_up\_small  
 [PreviewDeckN] rate\_temp\_up\_small



**[SamplerN] rate\_temp\_up\_small**

Holds the speed one small step higher while active

**Range** binary

**Feedback** Temp up button & Speed slider

**[ChannelN] rateRange**

**[PreviewDeckN] rateRange**

**[SamplerN] rateRange**

Sets the range of the Speed slider (0.08 = 8%)

This is a *ControlPotMeter control*.

**Range** 0.0..4.0

**Feedback** none, until you move the Speed slider

**[ChannelN] rateSearch**

**[PreviewDeckN] rateSearch**

**[SamplerN] rateSearch**

Seeks forward (positive values) or backward (negative values) at a speed determined by the value

This is a *ControlPotMeter control*.

**Range** -300..300

**Feedback** Deck seeks

**[ChannelN] rateEngine**

**[PreviewDeckN] rateEngine**

**[SamplerN] rateEngine**

Actual rate (used in visuals, not for control)

**[ChannelN] reloop\_andstop**

**[PreviewDeckN] reloop\_andstop**

**[SamplerN] reloop\_andstop**

Activate current loop, jump to its loop in point, and stop playback.

**Range** binary

**Feedback** Loop range in waveform activates or deactivates and play position moves to loop in point.

Nuovo nella versione 2.1.0.

**[ChannelN] reloop\_toggle**

**[PreviewDeckN] reloop\_toggle**

**[SamplerN] reloop\_toggle**

Toggles the current loop on or off. If the loop is ahead of the current play position, the track will keep playing normally until it reaches the loop.

**Range** binary

**Feedback** Loop range in waveform activates or deactivates.

Nuovo nella versione 2.1.0.

**[ChannelN] repeat**

**[PreviewDeckN] repeat**

**[SamplerN] repeat**

Enable repeat-mode for the specified deck

**Range** binary

**Feedback** when track finishes, song loops to beginning

Nuovo nella versione 1.9.0.

**[ChannelN] reset\_key**  
**[PreviewDeckN] reset\_key**  
**[SamplerN] reset\_key**

Resets the key to the original track key.

**Range** binary

Nuovo nella versione 2.0.0.

**[ChannelN] reverse**  
**[PreviewDeckN] reverse**  
**[SamplerN] reverse**

Toggles playing the track backwards

**Range** binary

**Feedback** REV button

**[ChannelN] reverseroll**  
**[PreviewDeckN] reverseroll**  
**[SamplerN] reverseroll**

Enables reverse and slip mode while held (Censor)

**Range** binary

**Feedback** REV button

Nuovo nella versione 2.0.0.

**[ChannelN] scratch2**  
**[PreviewDeckN] scratch2**  
**[SamplerN] scratch2**

Affects absolute play speed & direction whether currently playing or not when *[ChannelN], scratch2\_enabled* is active. (multiplicative). Use JavaScript engine.*scratch* functions to manipulate in controller mappings.

**Range** -3.0..3.0

**Feedback** Waveform

Nuovo nella versione 1.8.0.

**[ChannelN] scratch2\_enabled**  
**[PreviewDeckN] scratch2\_enabled**  
**[SamplerN] scratch2\_enabled**

Takes over play speed & direction for *[ChannelN], scratch2*.

**Range** binary

**Feedback** Waveform

Nuovo nella versione 1.8.0.

**[ChannelN] slip\_enabled**  
**[PreviewDeckN] slip\_enabled**  
**[SamplerN] slip\_enabled**

Toggles slip mode. When active, the playback continues muted in the background during a loop, scratch etc. Once disabled, the audible playback will resume where the track would have been.

**Range** binary

**Feedback** Slip mode button

Nuovo nella versione 1.11.0.

**[ChannelN] stars\_up**

**[PreviewDeckN] stars\_up**

**[SamplerN] stars\_up**

Increase the rating of the currently loaded track (if the skin has star widgets in the decks section).

**Range** binary

**Feedback** Star count is increased in the deck's star widget and in the library table.

Nuovo nella versione 2.3.0.

**[ChannelN] stars\_down**

**[PreviewDeckN] stars\_down**

**[SamplerN] stars\_down**

Decrease the rating of the currently loaded track (if the skin has star widgets in the decks section).

**Range** binary

**Feedback** Star count is decreased in the deck's star widget and in the library table.

Nuovo nella versione 2.3.0.

**[ChannelN] start**

**[PreviewDeckN] start**

**[SamplerN] start**

Jump to start of track

**Range** binary

**Feedback** Track jumps to start

**[ChannelN] start\_play**

**[PreviewDeckN] start\_play**

**[SamplerN] start\_play**

Start playback from the beginning of the deck.

**Range** binary

**Feedback** Deck plays from beginning

Nuovo nella versione 1.10.0.

**[ChannelN] start\_stop**

**[PreviewDeckN] start\_stop**

**[SamplerN] start\_stop**

Seeks a player to the start and then stops it.

**Range** binary

**Feedback** Deck stops at the beginning.

Nuovo nella versione 1.10.0.

**[ChannelN] stop**

**[PreviewDeckN] stop**

**[SamplerN] stop**

Stops a player.

**Range** binary

**Feedback** Pause Button. Deck pauses at the current position.

Nuovo nella versione 1.10.0.

**[ChannelN] sync\_enabled**  
**[PreviewDeckN] sync\_enabled**  
**[SamplerN] sync\_enabled**

Syncs the *tempo* and *phase* (depending on quantize) to that of the other track (if *BPM* is detected on both). Click and hold for at least one second activates sync lock on that deck.

**Range** binary

**Feedback** If enabled, the *Sync* button stays lit and *tempo* slider snap to the appropriate value. Slider adjustments are linked on all decks that have *sync lock* enabled.

Nuovo nella versione 2.0.0.

**[ChannelN] sync\_master**  
**[PreviewDeckN] sync\_master**  
**[SamplerN] sync\_master**

Sets deck as leader clock.

**Range** binary

**Feedback** If enabled, the *Sync* button stays lit and *tempo* slider snap to the appropriate value. Slider adjustments are linked on all decks that have *sync lock* enabled.

Nuovo nella versione 2.0.0.

Cambiato nella versione 2.3.0: This button just enables *sync lock* mode (similar to *[ChannelN], sync\_enabled*), it does not actually guarantee the deck will be the sync leader. This will be fixed in a future version.

**[ChannelN] sync\_mode**  
**[PreviewDeckN] sync\_mode**  
**[SamplerN] sync\_mode**

Nuovo nella versione 2.0.0.

**Range**

| Value | Meaning                                 |
|-------|---|
| 0     | <i>Sync lock</i> disabled for that deck |
| 1     | Deck is sync follower                   |
| 2     | Deck is sync leader                     |

**[ChannelN] sync\_key**  
**[PreviewDeckN] sync\_key**  
**[SamplerN] sync\_key**

**Feedback** Key value widget

Match musical key.

Nuovo nella versione 2.0.0.

**[ChannelN] track\_color**  
**[PreviewDeckN] track\_color**  
**[SamplerN] track\_color**

Color of the currently loaded track or -1 if no track is loaded or the track has no color.

**Range** 3-Byte *RGB* color code (or -1)

**Feedback** Track color changes in the library view.

Nuovo nella versione 2.3.0.

**[ChannelN]track\_loaded**

**[PreviewDeckN]track\_loaded**

**[SamplerN]track\_loaded**

Whether a track is loaded in the specified deck

**Range** binary, read-only

**Feedback** Waveform and track metadata shown in deck

Nuovo nella versione 2.1.0.

**[ChannelN]track\_samplerate**

**[PreviewDeckN]track\_samplerate**

**[SamplerN]track\_samplerate**

Sample rate of the track loaded on the specified deck

**Range** absolute value, read-only

**Feedback** None

Nuovo nella versione 1.9.0.

**[ChannelN]track\_samples**

**[PreviewDeckN]track\_samples**

**[SamplerN]track\_samples**

Number of sound samples in the track loaded on the specified deck

**Range** absolute value, read-only

**Feedback** None

**[ChannelN]volume**

**[PreviewDeckN]volume**

**[SamplerN]volume**

Adjusts the channel volume fader

This is a *ControlPotMeter control*.

**Range** default

**Feedback** Deck volume fader

**[ChannelN]mute**

**[PreviewDeckN]mute**

**[SamplerN]mute**

Mutes the channel

**Range** binary

**Feedback** Mute button

Nuovo nella versione 2.0.0.

**[ChannelN]vinylcontrol\_enabled**

**[PreviewDeckN]vinylcontrol\_enabled**

**[SamplerN]vinylcontrol\_enabled**

Toggles whether a deck is being controlled by digital vinyl.

**Range** binary

**Feedback** When enabled, a vinyl indication should appear onscreen indicating green for enabled.

Nuovo nella versione 1.10.0.

**[ChannelN]vinylcontrol\_cueing**

[PreviewDeckN] vinylcontrol\_cueing

[SamplerN] vinylcontrol\_cueing

Determines how *cue points* are treated in vinyl control relative mode.

**Range**

| Value | Meaning   |
|-------|---|
| 0     | Cue points ignored  |
| 1     | One Cue - If needle is dropped after the <i>cue point</i> , track will seek to that cue point |
| 2     | Hot Cue - Track will seek to nearest previous <i>hotcue</i>                                   |

Nuovo nella versione 1.10.0.

[ChannelN] vinylcontrol\_mode

[PreviewDeckN] vinylcontrol\_mode

[SamplerN] vinylcontrol\_mode

Determines how vinyl control interprets needle information.

**Range**

| Value | Meaning  |
|-------|--|
| 0     | Absolute Mode (track position equals needle position and speed)                              |
| 1     | Relative Mode (track <i>tempo</i> equals needle speed regardless of needle position)         |
| 2     | Constant Mode (track <i>tempo</i> equals last known-steady tempo regardless of needle input) |

See *Control Mode* for details.

**Feedback** 3-way button indicates status

Nuovo nella versione 1.10.0.

[ChannelN] vinylcontrol\_status

[PreviewDeckN] vinylcontrol\_status

[SamplerN] vinylcontrol\_status

Provides visual feedback with regards to vinyl control status.

**Range** 0.0-3.0, read-only

**Feedback** Off for control disabled, green for control enabled, blinking yellow for when the needle reaches the end of the record, and red for needle skip detected

Nuovo nella versione 1.10.0.

[ChannelN] visual\_bpm

[PreviewDeckN] visual\_bpm

[SamplerN] visual\_bpm

*BPM* to display in the *GUI* (updated more slowly than the actual BPM).

**Range** ?

**Feedback** *BPM* value widget

Nuovo nella versione 2.0.0.

[ChannelN] visual\_key

[PreviewDeckN] visual\_key

[SamplerN] visual\_key

Current musical key after pitch shifting to display in the *GUI* using the notation selected in the preferences

**Range ?**

**Feedback** Key value widget

Nuovo nella versione 2.0.0.

**[ChannelN]visual\_key\_distance**

**[PreviewDeckN]visual\_key\_distance**

**[SamplerN]visual\_key\_distance**

The distance to the nearest key measured in cents

This is a *ControlPotMeter control*.

**Range** -0.5..0.5

**Feedback** Key value widget

Nuovo nella versione 2.0.0.

**[ChannelN]VuMeter**

**[PreviewDeckN]VuMeter**

**[SamplerN]VuMeter**

Outputs the current instantaneous deck volume

This is a *ControlPotMeter control*.

**Range** default

**Feedback** Deck VU meter

**[ChannelN]VuMeterL**

**[PreviewDeckN]VuMeterL**

**[SamplerN]VuMeterL**

Outputs the current instantaneous deck volume for the left channel

This is a *ControlPotMeter control*.

**Range** default

**Feedback** Deck VU meter L

**[ChannelN]VuMeterR**

**[PreviewDeckN]VuMeterR**

**[SamplerN]VuMeterR**

Outputs the current instantaneous deck volume for the right channel

This is a *ControlPotMeter control*.

**Range** default

**Feedback** Deck VU meter R

**[ChannelN]waveform\_zoom**

**[PreviewDeckN]waveform\_zoom**

**[SamplerN]waveform\_zoom**

Zooms the waveform to look ahead or back as needed.

**Range** 1.0 - 10.0

**Feedback** Waveform zoom buttons

Nuovo nella versione 1.11.0.

**[ChannelN]waveform\_zoom\_up**

**[PreviewDeckN]waveform\_zoom\_up**

**[SamplerN] waveform\_zoom\_up**

Waveform Zoom Out

**Range** ?

**Feedback** Waveform zoom buttons

Nuovo nella versione 1.11.0.

**[ChannelN] waveform\_zoom\_down**

**[PreviewDeckN] waveform\_zoom\_down**

**[SamplerN] waveform\_zoom\_down**

Waveform Zoom In

**Range** ?

**Feedback** Waveform zoom buttons

Nuovo nella versione 1.11.0.

**[ChannelN] waveform\_zoom\_set\_default**

**[PreviewDeckN] waveform\_zoom\_set\_default**

**[SamplerN] waveform\_zoom\_set\_default**

Return to default waveform zoom level

**Range** ?

**Feedback** Waveform zoom buttons

Nuovo nella versione 1.11.0.

**[ChannelN] wheel**

**[PreviewDeckN] wheel**

**[SamplerN] wheel**

Affects relative playback speed and direction persistently (additive offset & must manually be undone).

**Range** -3.0..3.0

**Feedback** Waveform

## Deprecated controls

These controls have been deprecated, new controller mappings should use the alternatives.

**[ChannelN] beatloop**

**[PreviewDeckN] beatloop**

**[SamplerN] beatloop**

Setup a loop over the set number of beats.

**Range** positive real number

**Feedback** A loop is shown over the set number of beats.

Deprecato dalla versione 2.1.0: Use *[ChannelN], beatloop\_size* and *[ChannelN], beatloop\_toggle* instead.

**[ChannelN] reloop\_exit**

**[PreviewDeckN] reloop\_exit**

**[SamplerN] reloop\_exit**

Toggles the current loop on or off. If the loop is ahead of the current play position, the track will keep playing normally until it reaches the loop.

**Range** binary

**Feedback** Loop range in waveform activates or deactivates.



Deprecato dalla versione 2.1.0: Use `[ChannelN], reloop_toggle` instead.

**[ChannelN] jog**

**[PreviewDeckN] jog**

**[SamplerN] jog**

Affects relative playback speed and direction for short instances (additive & is automatically reset to 0).

**Range** -3.0..3.0

**Feedback** waveform

Deprecato dalla versione ??: Use the JavaScript `engine.scratch` functions instead.

**[ChannelN] scratch**

**[PreviewDeckN] scratch**

**[SamplerN] scratch**

Affects playback speed and direction ([differently whether currently playing or not](<https://bugs.launchpad.net/mixxx/+bug/530281>)) (multiplicative).

**Range** -3.0..3.0

**Feedback** Waveform

Deprecato dalla versione ??: Use the JavaScript `engine.scratch` functions instead.

**[ChannelN] filter**

**[PreviewDeckN] filter**

**[SamplerN] filter**

Toggles the filter effect.

**Range** binary

**Feedback** Filter button

Nuovo nella versione 2.0.0.

Deprecato dalla versione 2.0.0: Use `[QuickEffectRack1_[ChannelN]_Effect1], enabled` instead.

**[ChannelN] filterDepth**

**[PreviewDeckN] filterDepth**

**[SamplerN] filterDepth**

Adjusts the intensity of the filter effect.

**Range** default

**Feedback** Filter depth knob

Nuovo nella versione 2.0.0.

Deprecato dalla versione 2.0.0: Use `[QuickEffectRack1_[ChannelN]], super1` instead.

**[ChannelN] filterLow**

**[PreviewDeckN] filterLow**

**[SamplerN] filterLow**

Adjusts the gain of the low *EQ* filter.

**Range** 0.0..1.0..4.0

**Feedback** Low EQ knob

Deprecato dalla versione 2.0.0: Use `[EqualizerRack1_[ChannelN]_Effect1], parameter1` instead.

**[ChannelN] filterLowKill**

**[PreviewDeckN] filterLowKill**

**[SamplerN] filterLowKill**

Holds the gain of the low *EQ* to -inf while active

**Range** binary

**Feedback** Low EQ *kill switch*

Deprecato dalla versione 2.0.0: Use `[EqualizerRack1_[ChannelI]_Effect1], button_parameter1` instead.

**[ChannelN] filterMid**

**[PreviewDeckN] filterMid**

**[SamplerN] filterMid**

Adjusts the gain of the mid *EQ* filter..

**Range** 0.0..1.0..4.0

**Feedback** Mid EQ knob

Deprecato dalla versione 2.0.0: Use `[EqualizerRack1_[ChannelI]_Effect1], parameter2` instead.

**[ChannelN] filterMidKill**

**[PreviewDeckN] filterMidKill**

**[SamplerN] filterMidKill**

Holds the gain of the mid *EQ* to -inf while active.

**Range** binary

**Feedback** Mid EQ *kill switch*

Deprecato dalla versione 2.0.0: Use `[EqualizerRack1_[ChannelI]_Effect1], button_parameter2` instead.

**[ChannelN] filterHigh**

**[PreviewDeckN] filterHigh**

**[SamplerN] filterHigh**

Adjusts the gain of the high *EQ* filter.

**Range** 0.0..1.0..4.0

**Feedback** High EQ knob

Deprecato dalla versione 2.0.0: Use `[EqualizerRack1_[ChannelI]_Effect1], parameter3` instead.

**[ChannelN] filterHighKill**

**[PreviewDeckN] filterHighKill**

**[SamplerN] filterHighKill**

Holds the gain of the high *EQ* to -inf while active.

**Range** binary

**Feedback** High EQ *kill switch*

Deprecato dalla versione 2.0.0: Use `[EqualizerRack1_[ChannelI]_Effect1], button_parameter3` instead.

**[ChannelN] beatloop\_X**

**[PreviewDeckN] beatloop\_X**

**[SamplerN] beatloop\_X**

Setup a loop over X beats. A control exists for X = 0.03125, 0.0625, 0.125, 0.25, 0.5, 1, 2, 4, 8, 16, 32, 64

**Range** toggle

**Feedback** A loop is shown over X beats.

Nuovo nella versione 1.10.0.

Deprecato dalla versione 2.0.0: Use `[ChannelN], beatloop_X_activate` instead.

## Global Sampler controls

These controls can be used to control all samplers.

### **[Samplers] show\_samplers**

**Range** binary

**Feedback** Shows Sampler bank(s)

### **[Sampler] SaveSamplerBank**

Save sampler configuration. Make currently loaded tracks in samplers instantly available at a later point.

**Range** binary

**Feedback** Opens file dialog. Configuration file can be named and saved.

### **[Sampler] LoadSamplerBank**

Load saved sampler configuration file and add tracks to the available samplers.

**Range** binary

**Feedback** Opens file dialog. Select configuration file.

## 16.5.4 Microphones and Auxiliary Channels

In contrast to *decks, preview decks and samplers*, microphones and auxiliary channels are input channels. You can map audio interface's inputs to mixxx's auxiliary input channels and connect external audio source to it (cellphone, mp3 player). Then you can use your *MIDI* controller to control its volume and some other parameters (orientation, gain, *volume*), apply effects and use the *prelisten* function.

---

**Nota:** Although the first auxiliary group is named `[Auxiliary1]`, the group for the first microphone is just called `[Microphone]`, not `[Microphone1]`.

---

### **[MicrophoneN] enabled**

### **[AuxiliaryN] enabled**

1 if a channel input is enabled, 0 if not.

**Range** binary

**Feedback** Microphone is enabled.

Nuovo nella versione 1.10.0.

Deprecato dalla versione 2.0.0: Use `[MicrophoneN], input_configured` instead.

### **[MicrophoneN] input\_configured**

### **[AuxiliaryN] input\_configured**

1 if there is input is configured for this channel, 0 if not.

**Range** binary, read-only

**Feedback** Configured channel in the sound preferences.

### **[MicrophoneN] master**

**[AuxiliaryN]master**

Hold value at 1 to mix channel input into the master output. For [MicrophoneN] use *[MicrophoneN]*, *talkover* instead. Note that [AuxiliaryN] also take *[AuxiliaryN]*, *orientation* into account.

**Range** binary

**Feedback** Auxiliary: Play button Microphone: N/A

**[AuxiliaryN]orientation**

Set channel orientation for the *crossfader*.

**Range**

| Value | Meaning                             |
|-------|-------------------------------------|
| 0     | Left side of crossfader             |
| 1     | Center (not affected by crossfader) |
| 2     | Right side of crossfader            |

**Feedback** None

Nuovo nella versione 1.10.0.

**[MicrophoneN]orientation**

Nuovo nella versione 1.10.0.

Deprecato dalla versione 1.10.0: The control is not processed in the Mixer, which is also why there are no orientation controls for Microphones in the GUI.

**[MicrophoneN]PeakIndicator**

**[AuxiliaryN]PeakIndicator**

Indicates when the signal is clipping (too loud for the hardware and is being distorted)

This is a *ControlPotMeter control*.

**Range** binary

**Feedback** Microphone Clip light

Nuovo nella versione 1.10.0.

**[MicrophoneN]PeakIndicatorL**

**[AuxiliaryN]PeakIndicatorL**

Indicates when the signal is clipping (too loud for the hardware and is being distorted) for the left channel

This is a *ControlPotMeter control*.

**Range** binary

**Feedback** Clip light (left)

Nuovo nella versione 2.0.0.

**[MicrophoneN]PeakIndicatorR**

**[AuxiliaryN]PeakIndicatorR**

Indicates when the signal is clipping (too loud for the hardware and is being distorted) for the right channel

This is a *ControlPotMeter control*.

**Range** binary

**Feedback** Clip light (right)

Nuovo nella versione 2.0.0.

**[MicrophoneN]pf1**

**[AuxiliaryN]pfl**

Toggles *headphone cueing (PFL)*.

**Range** binary

**Feedback** Headphone button

**[MicrophoneN]talkover**

**[AuxiliaryN]talkover**

Hold value at 1 to mix channel input into the master output. For [AuxiliaryN] use *[AuxiliaryN], master* instead. Note that [AuxiliaryN] also take *[AuxiliaryN], orientation* into account.

**Range** binary

**Feedback** Microphone: Talk button Auxiliary: N/A

Nuovo nella versione 1.10.0.

**[MicrophoneN]volume**

**[AuxiliaryN]volume**

Adjusts the channel volume fader

This is a *ControlPotMeter control*.

**Range** default

**Feedback** Microphone volume fader changes

Nuovo nella versione 1.10.0.

**[MicrophoneN]pregain**

**[AuxiliaryN]pregain**

Adjusts the gain of the input

This is a *ControlPotMeter control*.

**Range** 0.0..1.0..4.0

**Feedback** Microphone gain knob

**[MicrophoneN]mute**

**[AuxiliaryN]mute**

Mutes the channel

**Range** binary

**Feedback** Mute button

Nuovo nella versione 2.0.0.

**[MicrophoneN]VuMeter**

**[AuxiliaryN]VuMeter**

Outputs the current instantaneous channel volume

This is a *ControlPotMeter control*.

**Range** default

**Feedback** Microphone VU meter changes

Nuovo nella versione 1.10.0.

**[MicrophoneN]VuMeterL**

**[AuxiliaryN]VuMeterL**

Outputs the current instantaneous deck volume for the left channel

This is a *ControlPotMeter control*.

**Range** default

**Feedback** Deck VU meter L

Nuovo nella versione 2.0.0.

**[MicrophoneN]VuMeterR**

**[AuxiliaryN]VuMeterR**

Outputs the current instantaneous deck volume for the right channel

This is a *ControlPotMeter control*.

**Range** default

**Feedback** Deck VU meter R

Nuovo nella versione 2.0.0.

## 16.5.5 The [VinylControl] group

The [VinylControl] group can toggle the *vinyl control feature*.

**[VinylControl]Toggle**

Moves control by a vinyl control signal from one deck to another if using the single deck vinyl control (VC) feature.

**Range** binary

**Feedback** If VC isn't enabled on any decks, enable it on the first one we're receiving samples for. If VC is enabled on a single (exclusive) deck, and another deck is setup to receive samples, disable it on the former deck and enable it on the next eligible deck (ordered by deck number). If VC is enabled on multiple decks, don't do anything.

Nuovo nella versione 1.10.0.

**[VinylControl]show\_vinylcontrol**

Toggle the vinyl control section in skins.

**Range** binary

**Feedback** Vinyl controls are shown

Nuovo nella versione 1.10.0.

**[VinylControl]gain**

Allows to amplify the «phono» level of attached turntables to «line» level. This is equivalent to setting the *turntable boost* in *Options ▶ Preferences ▶ Vinyl Control*

**Range** binary

**Feedback** position of Boost slider in *Options ▶ Preferences ▶ Vinyl Control* (is not updated while viewing this Preferences page)

Nuovo nella versione 1.10.0.

## 16.5.6 The [Recording] controls

The controls in the [Recording] group can be used to query and control the *recording of your mix*.

### [Recording] toggle\_recording

Turns recording on or off.

**Range** binary

**Feedback** Recording icon

### [Recording] status

Indicates whether Mixxx is currently recording.

**Range**

| Value | Meaning              |
|-------|----------------------|
| 0     | Recording Stopped    |
| 1     | Initialize Recording |
| 2     | Recording Active     |

**Feedback** Recording icon

## 16.5.7 AutoDJ controls

The [AutoDJ] controls allow interacting with *AutoDJ*.

### [AutoDJ] enabled

Turns Auto DJ on or off.

**Range** binary

**Feedback** AutoDJ button

Nuovo nella versione 1.11.0.

### [AutoDJ] shuffle\_playlist

Shuffles the content of the Auto DJ playlist.

**Range** binary

**Feedback** Order of tracks in the AutoDJ playlist changes.

Nuovo nella versione 1.11.0.

### [AutoDJ] skip\_next

Skips the next track in the Auto DJ playlist.

**Range** binary

**Feedback** Skipped track is removed from the AutoDJ playlist.

Nuovo nella versione 1.11.0.

### [AutoDJ] fade\_now

Triggers the transition to the next track.

**Range** binary

**Feedback** Crossfader slider moves to the other side.

Nuovo nella versione 1.11.0.

## 16.5.8 The [Library] controls

The controls in the [Library] group can be used to navigate the *library*. Note that [Library], MoveUp and other Move and Scroll controls emulate keypresses and therefore require the Mixxx window to be focused.

### [Library]MoveUp

Equivalent to pressing the Up key on the keyboard

**Range** Binary

**Feedback** Currently selected item changes

Nuovo nella versione 2.1.0.

### [Library]MoveDown

Equivalent to pressing the Down key on the keyboard

**Range** Binary

**Feedback** Currently selected item changes

Nuovo nella versione 2.1.0.

### [Library]MoveVertical

Move the specified number of locations up or down. Intended to be mapped to an encoder knob.

**Range** Relative (positive values move down, negative values move up)

**Feedback** Currently selected item changes

Nuovo nella versione 2.1.0.

### [Library]ScrollUp

Equivalent to pressing the PageUp key on the keyboard

**Range** Binary

**Feedback** Currently selected item changes

Nuovo nella versione 2.1.0.

### [Library]ScrollDown

Equivalent to pressing the PageDown key on the keyboard

**Range** Binary

**Feedback** Currently selected item changes

Nuovo nella versione 2.1.0.

### [Library]ScrollVertical

Scroll the specified number of pages up or down. Intended to be mapped to an encoder knob.

**Range** Relative (positive values move down, negative values move up)

**Feedback** Currently selected item changes

Nuovo nella versione 2.1.0.

### [Library]MoveLeft

Equivalent to pressing the Left key on the keyboard

**Range** Binary

**Feedback** Currently selected item changes

Nuovo nella versione 2.1.0.



**[Library]MoveRight**

Equivalent to pressing the `Right` key on the keyboard

**Range** Binary

**Feedback** Currently selected item changes

Nuovo nella versione 2.1.0.

**[Library]MoveHorizontal**

Move the specified number of locations left or right. Intended to be mapped to an encoder knob.

**Range** Relative (positive values move right, negative values move left)

**Feedback** Currently selected item changes

Nuovo nella versione 2.1.0.

**[Library]MoveFocusForward**

Equivalent to pressing the `Tab` key on the keyboard

**Range** Binary

**Feedback** Currently focused pane changes

Nuovo nella versione 2.1.0.

**[Library]MoveFocusBackward**

Equivalent to pressing the `Shift + Tab` key on the keyboard

**Range** Binary

**Feedback** Currently focused pane changes

Nuovo nella versione 2.1.0.

**[Library]MoveFocus**

Move focus the specified number of panes forward or backwards. Intended to be mapped to an encoder knob.

**Range** Relative (positive values move forward, negative values move backward)

**Feedback** Currently focused pane changes

Nuovo nella versione 2.1.0.

**[Library]GoToItem**

Triggers different actions, depending on which interface element currently has keyboard focus:

|                         |   |
|-------------------------|---|
| <b>Search bar</b>       |   |
| text box                | moves focus to tracks table   |
| Clear button            | clears search text  |
| <b>Sidebar</b>          |   |
| collapsed node          | expands the item (except Tracks and Auto DJ)  |
| leaf node               | moves focus to tracks table   |
| <b>Tracks table</b>     | Performs the action selected in <i>Preferences ▶ Library ▶ Track Double-Click Action</i> (default is «Load selected track»). Also see <i>Preferences ▶ Decks ▶ Playing track protection</i> |
| <b>Dialogs / popups</b> | presses <code>Enter</code> . Note: the <i>Move...</i> controls allow to move button focus.  |

**Range** Binary

**Feedback** Context dependent

Nuovo nella versione 2.1.0.

**[Library]AutoDjAddBottom**

**[Playlist]AutoDjAddBottom**

Add selected track(s) to Auto DJ Queue (bottom).

**Range** Binary

**Feedback** Append track(s) to Auto DJ playlist

Nuovo nella versione 2.0.0.

**[Library]AutoDjAddTop**

**[Playlist]AutoDjAddTop**

Add selected track(s) to Auto DJ Queue (top).

**Range** Binary

**Feedback** Prepend track(s) to Auto DJ playlist

Nuovo nella versione 2.0.0.

**[Library]show\_coverart**

Toggle the Cover Art in Library

**Range** Binary

**[Library]font\_size\_increment**

Increase the size of the library font. If the row height is smaller than the font-size the larger of the two is used.

**Range** Binary

**Feedback** Library view

Nuovo nella versione 2.0.0.

**[Library]font\_size\_decrement**

Decrease the size of the library font

Nuovo nella versione 2.0.0.

**Range** Binary

**Feedback** Library view

**[Library]font\_size\_knob**

Increase or decrease the size of the library font

Nuovo nella versione 2.0.0.

**Range** Relative

**Feedback** Library view

**[Library]sort\_column**

Indicates the sorting column the track table

**Range**

| Value | Description | Library | Playlist | Crate | Browse |
|-------|-------------|---------|----------|-------|--------|
| 1     | Artist      | X       | X        | X     | X      |
| 2     | Title       | X       | X        | X     | X      |
| 3     | Album       | X       | X        | X     | X      |
| 4     | Albumartist | X       | X        | X     | X      |

continues on next page

Table 2 – continua dalla pagina precedente

| Value | Description        | Library | Playlist | Crate | Browse |
|-------|--------------------|---------|----------|-------|--------|
| 5     | Year               | X       | X        | X     | X      |
| 6     | Genre              | X       | X        | X     | X      |
| 7     | Composer           | X       | X        | X     | X      |
| 8     | Grouping           | X       | X        | X     | X      |
| 9     | Tracknumber        | X       | X        | X     | X      |
| 10    | Filetype           | X       | X        | X     | X      |
| 11    | Native Location    | X       | X        | X     | X      |
| 12    | Comment            | X       | X        | X     | X      |
| 13    | Duration           | X       | X        | X     | X      |
| 14    | Bitrate            | X       | X        | X     | X      |
| 15    | BPM                | X       | X        | X     | X      |
| 16    | ReplayGain         | X       | X        | X     | X      |
| 17    | Datetime Added     | X       | X        | X     | X      |
| 18    | Times Played       | X       | X        | X     | X      |
| 19    | Rating             | X       | X        | X     | X      |
| 20    | Key                | X       | X        | X     | X      |
| 21    | Preview            | X       | X        | X     | X      |
| 22    | Coverart           | X       | X        | X     |        |
| 23    | Position           |         | X        |       |        |
| 24    | Playlist ID        |         | X        |       |        |
| 25    | Location           |         | X        |       |        |
| 26    | Filename           |         |          |       | X      |
| 27    | File Modified Time |         |          |       | X      |
| 28    | File Creation Time |         |          |       | X      |
| 29    | Sample Rate        |         |          |       |        |
| 30    | Track Color        | X       | X        | X     |        |

**Feedback** Sorting indicator in the column headers of the track table

Nuovo nella versione 2.3.0.

**[Library] sort\_column\_toggle**

Equivalent to clicking on column headers. A new value sets *[Library], sort\_column* to that value and *[Library], sort\_order* to 0, setting the same value again will toggle *[Library], sort\_order*.

**Range** Same as for *[Library], sort\_column* or value 0 for sorting according the current column with the cursor on it

**Feedback** Sorting indicator in the column headers of the track table

Nuovo nella versione 2.3.0.

**[Library] sort\_order**

Indicate the sort order of the track tables.

**Range** Binary (0 for ascending, 1 for descending)

**Feedback** Sorting indicator in the column headers of the track table

Nuovo nella versione 2.3.0.

**[Library] track\_color\_prev**

Set color of selected track to previous color in palette.

**Range** Binary

**Feedback** Track color changes in the library view.

Nuovo nella versione 2.3.0.

**[Library]track\_color\_next**

Set color of selected track to next color in palette.

**Range** Binary

**Feedback** Track color changes in the library view.

Nuovo nella versione 2.3.0.

## 16.5.9 The [Shoutcast] controls

**[Shoutcast]enabled**

Shows if live Internet broadcasting is enabled.

**Range** ?

**Feedback** shoutcast only supports mp3 format as field

**[Shoutcast]status**

This control displays whether broadcasting connection to Shoutcast server was successfully established.

**Range** binary

**Feedback** None

## 16.5.10 The [Playlist] controls

[Playlist] controls allow navigating the sidebar and tracks table directly without considering the currently focused widget. This is helpful when another application's window is focused. This group is going to be deprecated at some point, with its controls added to [Library] above.

**Vedi anche:**

See [bug #1772184](#) for the current status.

**[Playlist]SelectPlaylist**

Scrolls the given number of items (view, playlist, crate, etc.) in the side pane (can be negative for reverse direction).

**Range** relative value

**Feedback** Library sidebar highlight

**[Playlist]SelectTrackKnob**

Scrolls the given number of tracks in the track table (can be negative for reverse direction).

**Range** relative value

**Feedback** Library track table highlight

**[Playlist]LoadSelectedIntoFirstStopped**

Loads the currently highlighted song into the first stopped deck

Deprecato dalla versione 2.1.0: Use *[Library],GoToItem* instead.

**[Playlist]SelectNextPlaylist**

Switches to the next view (Library, Queue, etc.)

Deprecato dalla versione 2.1.0: Use *[Library],MoveDown* instead.

**[Playlist]SelectPrevPlaylist**

**range** binary

**feedback** Library sidebar

Switches to the previous view (Library, Queue, etc.)

Deprecato dalla versione 2.1.0: Use *[Library], MoveUp* instead.

**[Playlist]ToggleSelectedSidebarItem**

Toggles (expands/collapses) the currently selected sidebar item.

Nuovo nella versione 1.11.0.

Deprecato dalla versione 2.1.0: Use *[Library], GoToItem* instead.

**[Playlist]SelectNextTrack**

Scrolls to the next track in the track table.

Deprecato dalla versione 2.1.0: Use *[Library], MoveDown* instead.

**[Playlist]SelectPrevTrack**

Scrolls to the previous track in the track table.

Deprecato dalla versione 2.1.0: Use *[Library], MoveUp* instead.

## 16.5.11 The [Controls] controls

The [Controls] group contains controls that didn't fit in any other group.

**[Controls]touch\_shift**

Once enabled, all touch tab events are interpreted as right click. This control has been added to provide touchscreen compatibility in 2.0 and might be replaced by a general modifier solution in the future.

**Range** binary

**Feedback** All Widgets

Nuovo nella versione 2.0.0.

**[Controls]AutoHotcueColors**

If enabled, colors will be assigned to newly created *hotcues* automatically.

**Range** binary

**Feedback** None

Nuovo nella versione 2.3.0.

**[Controls]ShowDurationRemaining**

Represents the current state of the remaining time duration display of the loaded track.

**Range**

| Value | Meaning   |
|-------|---|
| 0     | currently showing elapsed time, sets to remaining time                      |
| 1     | currently showing remaining time , sets to elapsed time                     |
| 2     | currently showing both (that means we are showing remaining, set to elapsed |

**Feedback** None

## 16.5.12 The Effects Framework

In the list below,

- EffectRack1 leaves room for future expansion to multiple EffectRacks.
- N ranges from 1 to [EffectRack1], num\_effectunits, inclusive.
- M ranges from 1 to [EffectRack1\_EffectUnitN], num\_effectslots, inclusive. (For a given value of N)
- K ranges from 1 to [EffectRack1\_EffectUnitN\_EffectM], num\_parameters, inclusive. (For given values of N and M)
- I ranges from 1 to [Master], num\_decks, inclusive.
- J ranges from 1 to [Master], num\_samplers, inclusive.

Nuovo nella versione 2.0.0.

### Linking Values

Effect parameters can be linked to the effect's metaknob. This linkage can be user-controlled by changing the link\_type and the link\_inverse control of the parameter. The default link type is loaded from the effect parameter's manifest's linkHint property.

| Link Type         | Integer Value | Interpretation                               |
|-------------------|---------------|--|
| None              | 0             | Not controlled by the metaknob               |
| Linked            | 1             | Controlled by the metaknob as it is          |
| Linked Left       | 2             | Controlled by the left side of the metaknob  |
| Linked Right      | 3             | Controlled by the right side of the metaknob |
| Linked Left Right | 4             | Controlled by both sides of the metaknob     |

| Link Inverse | Integer Value | Interpretation                 |
|--------------|---------------|--------------------------------|
| Normal       | 0             | Linked in equal relation       |
| Inverse      | 1             | Linked in an inverse relation. |

### EQs and Filters

*Equalizers* and filters are special effects units. The EQs are controlled by [EqualizerRack1\_[ChannelI]\_Effect1] and the filter knob is controlled by [QuickEffectRack1\_[ChannelI]], super1 and [QuickEffectRack1\_[ChannelI]\_Effect1], enabled. Users can choose between several options for the effects loaded in these racks in the Equalizers section of the Preferences window.

## Controls

### [EffectRack1] show

Show the Effect Rack

**Range** binary

### [EffectRack1] num\_effectunits

### [EqualizerRack1] num\_effectunits

### [QuickEffectRack1] num\_effectunits

The number of EffectUnits in this rack

**Range** integer, read-only

### [EffectRack1] clear

### [EqualizerRack1] clear

### [QuickEffectRack1] clear

Clear the Effect Rack

**Range** binary

### [EffectRack1\_EffectUnitN] chain\_selector

### [EqualizerRack1\_[ChannelI]] chain\_selector

### [QuickEffectRack1\_[ChannelI]] chain\_selector

Select EffectChain preset. > 0 goes one forward; < 0 goes one backward.

**Range** +/-1

### [EffectRack1\_EffectUnitN] clear

### [EqualizerRack1\_[ChannelI]] clear

### [QuickEffectRack1\_[ChannelI]] clear

Clear the currently loaded EffectChain in this EffectUnit.

**Range** binary

### [EffectRack1\_EffectUnitN] enabled

### [EqualizerRack1\_[ChannelI]] enabled

### [QuickEffectRack1\_[ChannelI]] enabled

If true, the EffectChain in this EffectUnit will be processed. Meant to allow the user a quick toggle for the effect unit.

**Range** binary, default true

### [EffectRack1\_EffectUnitN] focused\_effect

### [EqualizerRack1\_[ChannelI]] focused\_effect

### [QuickEffectRack1\_[ChannelI]] focused\_effect

0 indicates no effect is focused; > 0 indicates the index of the focused effect. Focusing an effect only does something if a controller mapping changes how it behaves when an effect is focused.

**Range** 0..num\_effects

### [EffectRack1\_EffectUnitN] group\_[ChannelI]\_enable

### [EqualizerRack1\_[ChannelI]] group\_[ChannelI]\_enable

### [QuickEffectRack1\_[ChannelI]] group\_[ChannelI]\_enable

Whether or not this EffectChain applies to Deck I

**Range** binary

### [EffectRack1\_EffectUnitN] group\_[Headphone]\_enable

Whether or not this EffectChain applies to the Headphone output

**Range** binary

**[EffectRack1\_EffectUnitN]group\_[Master]\_enable**

Whether or not this EffectChain applies to the Master output

**Range** binary

**[EffectRack1\_EffectUnitN]group\_[SamplerJ]\_enable**

Whether or not this EffectChain applies to Sampler J

**Range** binary

**[EffectRack1\_EffectUnitN]loaded**

**[EqualizerRack1\_[ChannelI]]loaded**

**[QuickEffectRack1\_[ChannelI]]loaded**

Whether an EffectChain is loaded into the EffectUnit

**Range** binary, read-only

**[EffectRack1\_EffectUnitN]mix**

**[EqualizerRack1\_[ChannelI]]mix**

**[QuickEffectRack1\_[ChannelI]]mix**

The dry/wet mixing ratio for this EffectChain with the EngineChannels it is mixed with

This is a *ControlPotMeter control*.

**Range** 0.0..1.0

**[EffectRack1\_EffectUnitN]next\_chain**

**[EqualizerRack1\_[ChannelI]]next\_chain**

**[QuickEffectRack1\_[ChannelI]]next\_chain**

Cycle to the next EffectChain preset after the currently loaded preset.

**Range** binary

**[EffectRack1\_EffectUnitN]num\_effects**

**[EqualizerRack1\_[ChannelI]]num\_effects**

**[QuickEffectRack1\_[ChannelI]]num\_effects**

The number of Effects that this EffectChain has

**Range** integer, read-only

**[EffectRack1\_EffectUnitN]num\_effectslots**

**[EqualizerRack1\_[ChannelI]]num\_effectslots**

**[QuickEffectRack1\_[ChannelI]]num\_effectslots**

The number of effect slots available in this EffectUnit.

**Range** integer, read-only

**[EffectRack1\_EffectUnitN]prev\_chain**

**[EqualizerRack1\_[ChannelI]]prev\_chain**

**[QuickEffectRack1\_[ChannelI]]prev\_chain**

Cycle to the previous EffectChain preset before the currently loaded preset.

**Range** binary

**[EffectRack1\_EffectUnitN]show\_focus**

**[EqualizerRack1\_[ChannelI]]show\_focus**

**[QuickEffectRack1\_[ChannelI]]show\_focus**

Whether to show focus buttons and draw a border around the focused effect in skins. This should not be manipulated by skins; it should only be changed by controller mappings.

**Range** binary

**[EffectRack1\_EffectUnitN]show\_parameters**



**[EqualizerRack1\_[ChannelI]] show\_parameters**  
**[QuickEffectRack1\_[ChannelI]] show\_parameters**

**Range** binary

Whether to show all the parameters of each effect in skins or only show metaknobs.

**[EffectRack1\_EffectUnitN] super1**  
**[EqualizerRack1\_[ChannelI]] super1**  
**[QuickEffectRack1\_[ChannelI]] super1**

The EffectChain superknob. Moves the metaknobs for each effect in the chain.

This is a *ControlPotMeter control*.

**Range** 0.0..1.0

**[EffectRack1\_EffectUnitN\_EffectM] clear**  
**[EqualizerRack1\_[ChannelI]\_Effect1] clear**  
**[QuickEffectRack1\_[ChannelI]\_Effect1] clear**

Clear the currently loaded Effect in this Effect slot from the EffectUnit.

**Range** binary

**[EffectRack1\_EffectUnitN\_EffectM] effect\_selector**  
**[EqualizerRack1\_[ChannelI]\_Effect1] effect\_selector**  
**[QuickEffectRack1\_[ChannelI]\_Effect1] effect\_selector**

Select Effect – >0 goes one forward, <0 goes one backward.

**Range** +/-1

**[EffectRack1\_EffectUnitN\_EffectM] enabled**  
**[EqualizerRack1\_[ChannelI]\_Effect1] enabled**  
**[QuickEffectRack1\_[ChannelI]\_Effect1] enabled**

If true, the effect in this slot will be processed. Meant to allow the user a quick toggle for this effect.

**Range** binary, default true

**[EffectRack1\_EffectUnitN\_EffectM] loaded**  
**[EqualizerRack1\_[ChannelI]\_Effect1] loaded**  
**[QuickEffectRack1\_[ChannelI]\_Effect1] loaded**

Whether an Effect is loaded into this EffectSlot

**Range** binary, read-only

**[EffectRack1\_EffectUnitN\_EffectM] next\_effect**  
**[EqualizerRack1\_[ChannelI]\_Effect1] next\_effect**  
**[QuickEffectRack1\_[ChannelI]\_Effect1] next\_effect**

Cycle to the next effect after the currently loaded effect.

**Range** binary

**[EffectRack1\_EffectUnitN\_EffectM] num\_parameters**  
**[EqualizerRack1\_[ChannelI]\_Effect1] num\_parameters**  
**[QuickEffectRack1\_[ChannelI]\_Effect1] num\_parameters**

The number of parameters the currently loaded effect has.

**Range** integer, read-only, 0 if no effect is loaded

**[EffectRack1\_EffectUnitN\_EffectM] num\_parameterslots**  
**[EqualizerRack1\_[ChannelI]\_Effect1] num\_parameterslots**  
**[QuickEffectRack1\_[ChannelI]\_Effect1] num\_parameterslots**

The number of parameter slots available.

**Range** integer, read-only

[EffectRack1\_EffectUnitN\_EffectM]num\_button\_parameters  
 [EqualizerRack1\_[ChannelI]\_Effect1]num\_button\_parameters  
 [QuickEffectRack1\_[ChannelI]\_Effect1]num\_button\_parameters

The number of button parameters the currently loaded effect has.

**Range** integer, read-only, 0 if no effect is loaded

[EffectRack1\_EffectUnitN\_EffectM]num\_button\_parameterslots  
 [EqualizerRack1\_[ChannelI]\_Effect1]num\_button\_parameterslots  
 [QuickEffectRack1\_[ChannelI]\_Effect1]num\_button\_parameterslots

The number of button parameter slots available.

**Range** integer, read-only

[EffectRack1\_EffectUnitN\_EffectM]meta  
 [EqualizerRack1\_[ChannelI]\_Effect1]meta  
 [QuickEffectRack1\_[ChannelI]\_Effect1]meta

Controls the parameters that are linked to the metaknob.

This is a *ControlPotMeter control*.

**Range** 0..1

[EffectRack1\_EffectUnitN\_EffectM]prev\_effect  
 [EqualizerRack1\_[ChannelI]\_Effect1]prev\_effect  
 [QuickEffectRack1\_[ChannelI]\_Effect1]prev\_effect

Cycle to the previous effect before the currently loaded effect.

**Range** binary

[EffectRack1\_EffectUnitN\_EffectM]parameterK  
 [EqualizerRack1\_[ChannelI]\_Effect1]parameterK  
 [QuickEffectRack1\_[ChannelI]\_Effect1]parameterK

The scaled value of the Kth parameter. See the [Parameter Values](#) section for more information.

This is a *ControlPotMeter control*.

**Range** double

[EffectRack1\_EffectUnitN\_EffectM]parameterK\_link\_inverse  
 [EqualizerRack1\_[ChannelI]\_Effect1]parameterK\_link\_inverse  
 [QuickEffectRack1\_[ChannelI]\_Effect1]parameterK\_link\_inverse

The link direction of the Kth parameter to the effect's metaknob.

**Range** bool

[EffectRack1\_EffectUnitN\_EffectM]parameterK\_link\_type  
 [EqualizerRack1\_[ChannelI]\_Effect1]parameterK\_link\_type  
 [QuickEffectRack1\_[ChannelI]\_Effect1]parameterK\_link\_type

The link type of the Kth parameter to the effects's metaknob.

**Range** enum

[EffectRack1\_EffectUnitN\_EffectM]parameterK\_loaded  
 [EqualizerRack1\_[ChannelI]\_Effect1]parameterK\_loaded  
 [QuickEffectRack1\_[ChannelI]\_Effect1]parameterK\_loaded

Whether or not the Kth parameter slot has an effect parameter loaded into it.

**Range** binary, read-only

[EffectRack1\_EffectUnitN\_EffectM]parameterK\_type

`[EqualizerRack1_[ChannelI]_Effect1]parameterK_type`  
`[QuickEffectRack1_[ChannelI]_Effect1]parameterK_type`  
 The type of the Kth parameter value. See the Parameter Value Types table.

**Range** integer, read-only

`[EffectRack1_EffectUnitN_EffectM]button_parameterK`  
`[EqualizerRack1_[ChannelI]_Effect1]button_parameterK`  
`[QuickEffectRack1_[ChannelI]_Effect1]button_parameterK`  
 The value of the Kth parameter. See the Parameter Values section for more information.

**Range** double

`[EffectRack1_EffectUnitN_EffectM]button_parameterK_loaded`  
`[EqualizerRack1_[ChannelI]_Effect1]button_parameterK_loaded`  
`[QuickEffectRack1_[ChannelI]_Effect1]button_parameterK_loaded`  
 Whether or not the Kth parameter slot has an effect parameter loaded into it.

**Range** binary, read-only

`[EffectRack1_EffectUnitN_EffectM]button_parameterK_type`  
`[EqualizerRack1_[ChannelI]_Effect1]button_parameterK_type`  
`[QuickEffectRack1_[ChannelI]_Effect1]button_parameterK_type`  
 The type of the Kth parameter value. See the Parameter Value Types table.

**Range** integer, read-only

### 16.5.13 Removed controls

These controls have been removed from Mixxx. Skins and controller mappings that attempt to use them will not work correctly.

**[ChannelN] flanger**  
 Toggles the flanger effect.

Deprecato dalla versione 2.0.0: This control has been **removed** without a direct replacement. Use the *effects framework* instead.

**[ChannelN] Hercules1**  
**[ChannelN] Hercules2**  
**[ChannelN] Hercules3**  
**[ChannelN] Hercules4**  
 Deprecato dalla versione ??: This control has been **removed**.

**[ChannelN] NextTask**  
 Deprecato dalla versione ??: This control has been **removed**.

**[ChannelN] NextTrack**  
 Deprecato dalla versione ??: This control has been **removed**.

**[ChannelN] PrevTask**  
 Deprecato dalla versione ??: This control has been **removed**.

**[ChannelN] PrevTrack**  
 Deprecato dalla versione ??: This control has been **removed**.

**[ChannelN] ttransform**  
 Deprecato dalla versione ??: This control has been **removed**.

**[Flanger] lfoDepth**  
 Adjusts the intensity of the flange effect

Deprecato dalla versione 2.0.0: This control has been **removed** without a direct replacement. Use the *effects framework* instead.

**[Flanger] lfoDelay**

Adjusts the phase delay of the flange effect in microseconds

Deprecato dalla versione 2.0.0: This control has been **removed** without a direct replacement. Use the *effects framework* instead.

**[Flanger] lfoPeriod**

Adjusts the wavelength of the flange effect in microseconds

Deprecato dalla versione 2.0.0: This control has been **removed** without a direct replacement. Use the *effects framework* instead.

## 16.6 The Mixxx Settings Directory

The Mixxx settings directory contains all user data and settings of your Mixxx installation.

### 16.6.1 Location

#### Linux

~/ .mixxx/

**Note:** make sure you have «Show hidden files» enabled in your file manager in order to show all dot-files and directories.

#### Windows

Vista and up: %LOCALAPPDATA%\Mixxx

XP and below: %USERPROFILE%\Local Settings\Application Data\Mixxx\

Type either of those into the location bar of a Computer or Folder window.

#### macOS

Mixxx 2.3: ~/Library/Containers/org.mixxx.mixxx/Data/Library/Application Support/Mixxx

Mixxx 2.2 and earlier: ~/Library/Application Support/Mixxx

### 16.6.2 Content

**analysis** This contains all waveform analysis data. This is used to compose a track’s scrolling waveform and track overview. If not existent, this data will be recreated each time a track is loaded into a Mixxx deck. Thus it does not belong to the essential data that needs to be backed up.

**broadcast\_profiles** All broadcast profiles you have configured.

**controllers** All controller mappings you stored. This can be downloaded and *self-built mappings*, as well as built-in mappings that you modified in *Preferences > Controllers > YourController* manually or with the MIDI Wizard.

**effects.xml** The current configuration of the 4 effect units, incl. the state of all controls.

**mixxx.cfg** Everything you configured in the Preferences, deck settings, skin settings, AutoDJ configuration, effect routing etc.

**mixxx.log[.NN]** Log files of the last few Mixxx sessions, with `mixxx.log` being the most recent one, followed by `mixxx.log.1` etc.

**mixxxdb.sqlite** The Mixxx library database. All track locations, all track metadata, saved cues, loops, colors, playlists, crates, ...

**samplers.xml** Stores tracks currently loaded to sample decks.

**sandbox.cfg** This is used under macOS to track which files Mixxx will have access to

**soundconfig.xml** Sound device configuration from Preferences > Sound Hardware

## 16.7 Additional Resources

Got questions? Need more information? Want to *contribute*? There are a variety of other resources where you can find out more:

- **Mixxx Website:** For general information and updates, as well as the latest news on Mixxx, go to: <https://mixxx.org>
- **Mixxx Wiki:** For up-to-date information about supported DJ hardware, documentation on making controller mappings, and other tips and tricks, go to: <https://github.com/mixxxdj/mixxx/wiki>
- **Keyboard Shortcuts:** This a list for all default Mixxx keyboard shortcuts. Please note that these shortcuts are for keyboards configured in English layout and default shortcuts may be different if your language setting is not English. *default keyboard mappings*
- **Mixxx Community Forums:** To search for answers, post your question or answer other DJ's questions, go to: <https://mixxx.org/forums>
- **Mixxx Zulip Chat:** Hang out with Mixxx developers and users on our Zulip chat. Stand-alone apps for Zulip can be configured to use the server `mixxx.zulipchat.com`.
- **Mixxx Source Code:** To download the source code for Mixxx, go to: <https://github.com/mixxxdj/mixxx>
- **Mixxx Bug Tracker:** To report a bug or request a feature, go to: <https://bugs.launchpad.net/mixxx>
- **Mixxx Translations:** To translate Mixxx and promote your mother tongue, go to: <https://www.transifex.com/mixxx-dj-software/public/>. Please read the [Translation FAQ](#) first.
- **Social Media:** Follow us on [Twitter](#), and [Facebook](#).

## 16.8 Changelog

### 16.8.1 2.3.2 (Unreleased)

- Playlist: Enable sorting by color #4352 lp:1945976
- Fix crash when using Doubling/Halving/etc. BPM from track's Properties window on tracks without BPM #4587 lp:1955853
- Fix writing metadata on Windows for files that have never been played #4586 lp:1955331
- Preserve file creation time when writing metadata on Windows #4586 lp:1955314
- Fix handling of file extension when importing and exporting sampler settings #4539
- Fix crash when using an empty directory as resource path using the `--resource-path` command line option #4575 lp:1934560

## Packaging

- Downloads of external dependencies are placed in build/downloads
- The sources for libkeyfinder are now expected in build/downloads/libkeyfinder-2.2.5.zip instead of build/download/libkeyfinder/v2.2.5.zip
- CMake: Adjust the download directory and name of external dependencies #4511
- Fix/Improve Appstream metainfo #4344 #4346 #4349

### 16.8.2 2.3.1 (2021-09-29)

- Added mapping for the Numark DJ2GO2 Touch controller #4108 #4287
- Added mapping for the Numark Mixtrack Pro FX controller #4160
- Updated mapping for Behringer DDM4000 mixer #4262
- Updated mapping for Denon MC7000 controller #4021
- Hercules Inpulse 300: Add better FX controls and other minor improvements #4246
- Denon MC7000: Improve slip mode and jog wheel handling #4021 #4324
- Disabled detection of keyboards and mice as HID controllers #4243
- Disabled detection of all HID controllers with Apple's vendor ID. Apple doesn't build actual controllers. #4260 #4273
- Add support for HiDPI scale factors of 125% and 175% (only with Qt 5.14+) lp1938102 #4161
- Fix unhandled exception when parsing corrupt Rekordbox PDB files lp1933853 #4040
- Fix Echo effect adding left channel samples to right channel #4141
- Fix bad phase seek when starting from preroll lp1930143 #4093
- Fix bad phase seek when a channel's audible status changes #4156
- Tango skin: Show crossfader assign buttons by default #4046
- Fix keyfinder library in arm64 builds #4047
- Fix wrong track being recorded in History lp1933991 #4041 #4059 #4107 #4296
- Fix support for relative paths in the skin system which caused missing images in third-party skins #4151
- Fix relocation of directories with special/reserved characters in path name #4146
- Update keyboard shortcuts sheet #4042
- Library: resize the Played checkbox and BPM lock with the library font #4050
- Don't allow Input focus on waveforms #4134
- Fix performance issue on AArch64 by enabling flush-to-zero for floating-point arithmetic #4144
- Fix custom key notation not restored correctly after restart #4136
- Traktor S3: Disable scratch when switching decks to prevent locked scratch issue #4073
- FFmpeg: Ignore inaudible samples before start of stream #4245
- Controller Preferences: Don't automatically enable checkbox if controller is disabled #4244 lp:1941042
- Tooltips: Always show tooltips in preferences #4198 lp:1840493

- Tooltips: Use item label for tooltips in library side bar and show ID when debugging. #4247
- Library sidebar: Also activate items on PageUp/Down events. #4237
- Fix handling of preview button cell events in developer mode. #4264 lp:1929141
- Auto DJ: Fix bug which could make an empty track stop Auto DJ. #4267 lp:1941743
- Fix Auto DJ skipping tracks randomly #4319 lp:1941989
- Fix high CPU load due to extremely high internal sync clock values #4312 lp:1943320
- Fix preference option for re-analyzing beatgrids imported from other software #4288
- Fix wrong base tag used for deployment and displayed in About dialog #4070

## Packaging

- It is no longer necessary to manually copy the udev rule file in packaging scripts. Now pkg-config is used to determine the udevdir used to install the rules file in the CMake install step when CMAKE\_INSTALL\_PREFIX is / or /usr. #4126
- Various build issues on FreeBSD are fixed #4122 #4123 #4124
- .desktop file has been renamed to org.mixxx.Mixxx.desktop according to freedesktop standards #4206
- Uses system provided hidapi library if version >= 0.10.1 #4215
- Please update PortAudio to 19.7 if you have not done so already. This is required for Mixxx to work with PipeWire via the JACK API for many devices.
- Install multiple sizes of rasterized icons #4204 #4315 #4254
- CMake: Fixed detection of SoundTouch pkgconfig file and version #4209
- Fix AppStream metainfo #4205 #4317

## 16.8.3 2.3.0 (2021-06-28)

### Hotcues

- Add hotcue colors and custom labels by right clicking hotcue buttons or right clicking hotcues on overview waveforms #2016 #2520 #2238 #2560 #2557 #2362
- Mouse hover cues on overview waveform to show time remaining until the cue #2238

### Hotcue & Track Colors

- Add configurable color per track #2470 #2539 #2545 #2630 lp:1100882
- Add customizable color palettes for hotcue and track colors #2530 #2589 #3749 #2902
- Add hotcue color find-and-replace tool #2547

## Importing From Other DJ Software

- Import cue points, track colors, and playlists from Serato file tags & database #2480 #2526 #2499 #2495 #2673 #3885
  - Note: Mixxx does not yet support multiple loops per track. We are [working on this for Mixxx 2.4](#). In Mixxx 2.3, if you import a track with multiple loops from Serato, Mixxx will use the first loop cue as the single loop Mixxx currently supports. The imported loops are still stored in Mixxx's database and are treated as hotcues in Mixxx 2.3. If you do not delete these hotcues, they will be usable as loops in Mixxx 2.4. Serato keeps loops and hotcues in separate lists, but Mixxx does not, so loops from Serato are imported starting as hotcue 9.
- Import cue points, track colors, and playlists from Rekordbox USB drives #2119 #2555 #2543 #2779
  - Note: The first Rekordbox memory cue is imported for the main cue button in Mixxx and the remaining Rekordbox memory cues are imported as Mixxx hotcues, starting with the next hotcue number after the last hotcue from Rekordbox.
  - Note: Mixxx does not yet support multiple loops per track. Imported loops from Rekordbox are treated like imported loops from Serato, so refer to the note above for details.

## Intro & Outro Cues

- Add intro & outro range cues with automatic silence detection #1242
- Show duration of intro & outro ranges on overview waveform #2089
- Use intro & outro cues in AutoDJ transitions #2103

## Deck cloning

- Add deck cloning (also known as «instant doubles» in other DJ software) by dragging and dropping between decks #1892 and samplers #3200
- Clone decks by double pressing the load button on a controller (with option to disable this) #2024 #2042

## Skins & GUI

- Aesthetically revamped LateNight skin #2298 #2342
- Right click overview waveform to show time remaining until that point #2238
- Show track info dialog when double clicking track labels in decks #2990
- Show track context menu when right clicking text in decks #2612 #2675 #2684 #2696
- Add laptop battery widget to skins #2283 #2277 #2250 #2228 #2221 #2163 #2160 #2147 #2281 #2319 #2287
- Show when passthrough mode is active on overview waveforms #2575 #2616
- Changed format of currently playing track in window title from «artist, title» to «artist - title» #2807
- Workaround Linux skin change crash #3144 lp:1885009
- Fix touch control lp:1895431
- Fix broken knob interaction on touchscreens #3512
- AutoDJ: Make «enable» shortcut work after startup #3242
- Add rate range indicator #3693



- Allow menubar to be styled #3372 #3788
- Add Donate button to About dialog #3838 #3846
- Add Scrollable Skin Widget #3890
- Fix minor visual issues in Skins #3958 #3954 #3941 #3938 #3936 #3886 #3927 #3844 #3933 #3835 #3902 #3931

## Music Feature Analysis

- Multithreaded analysis for much faster batch analysis on multicore CPUs #1624 #2142 lp:1641153
- Fix bugs affecting key detection accuracy #2137 #2152 #2112 #2136
  - Note: Users who have not manually corrected keys are advised to clear all keys in their library by pressing Ctrl + A in the library, right clicking, going to Reset -> Key, then reanalyzing their library. This will freeze the GUI while Mixxx clears the keys; this is a known problem that we will not be able to fix for 2.3. Wait until it is finished and you will be able to reanalyze tracks for better key detection results.
- Remove VAMP plugin support and use Queen Mary DSP library directly. vamp-plugin-sdk and vamp-hostsdk are no longer required dependencies. #926
- Improvements BPM detection on non-const beatgrids #3626
- Fix const beatgrid placement #3965 #3973

## Music Library

- Add support for searching for empty fields (for example `crate: ""`) lp:1788086
- Improve synchronization of track metadata and file tags #2406
- Library Scanner: Improve hashing of directory contents #2497
- Rework of Cover Image Hashing lp:1607097 #2507 #2508
- MusicBrainz: Handle 301 status response #2510
- MusicBrainz: Add extended metadata support lp:1581256 #2522
- TagLib: Fix detection of empty or missing file tags lp:1865957 #2535
- Fix caching of duplicate tracks that reference the same file #3027
- Use 6 instead of only 4 compatible musical keys (major/minor) #3205
- Fix possible crash when trying to refocus the tracks table while another Mixxx window has focus #3201
- Don't create new tags in file when exporting metadata to it #3898
- Fix playlist files beginning with non-english characters not being loaded #3916
- Enable sorting in «Hidden Tracks» and «Missing Tracks» views #3828 lp:1828555 lp:1924616
- Fix track table being empty after start #3935 lp:1930546 lp:1924843

## Audio Codecs

- Add FFmpeg audio decoder, bringing support for ALAC files #1356
- Include LAME MP3 encoder with Mixxx now that the MP3 patent has expired [lp:1294128](#) [buildserver:#37](#) [buildserver:9e8bcee](#)
- Add Opus streaming and recording support. [lp:1338413](#)
- Remove support for SoundSource plugins because the code was not well-maintained and could lead to crashes [lp:1792747](#)
- Add HE-AAC encoding capabilities for recording and broadcasting #3615

## Audio Engine

- Fix loss of precision when dealing with floating-point sample positions while setting loop out position and seeking using vinyl control #3126 #3127
- Prevent moving a loop beyond track end #3117 [lp:1799574](#)
- Fix possible memory corruption using JACK on Linux #3160
- Fix changing of vinyl lead-in time [lp:1915483](#) #3781
- Fix tempo change of non-const beatgrid track on audible deck when cueing another track #3772
- Fix crash when changing effect unit routing #3882 [lp:1775497](#)
- Make microphone ducking use strength knob the same way in automatic & manual mode #2750

## Controllers

- Improve workflow for configuring controller mappings and editing mappings #2569 #3278 #3667
- Improve error reporting from controller scripts #2588
- Make hotcue and track colors mappable on controllers #2030 #2541 #2665 #2520
- Add way to change library table sorting from controllers #2118
- Add support for velocity sensitive sampler buttons in Components JS library #2032
- Add logging when script ControlObject callback is disconnected successfully #2054
- Add controller mapping for Roland DJ-505 #2111
- Add controller mapping for Numark iDJ Live II #2818
- Add controller mapping for Hercules DJControl Inpulse 200 #2542
- Add controller mapping for Hercules DJControl Jogvision #2370
- Add controller mapping for Pioneer DDJ-200 #3185 #3193 #3742 #3793 #3949
- Add controller mapping for Pioneer DDJ-400 #3479
- Add controller mapping for ION Discover DJ Pro #2893
- Add controller mapping for Native Instrument Traktor Kontrol S3 #3031
- Add controller mapping for Behringer BCR2000 #3342 #3943
- Add controller mapping for Behringer DDM4000 #3542

- Update controller mapping for Allen & Heath Xone K2 to add intro/outro cues #2236
- Update controller mapping for Hercules P32 for more accurate headmix control #3537
- Update controller mapping for Native Instruments Traktor Kontrol S4MK2 to add auto-slip mode and pitch fader range #3331
- Fix Pioneer DDJ-SB2 controller mapping auto tempo going to infinity bug #2559 lp:1846403
- Fix Numark Mixtrack Pro 3 controller mapping inverted FX on/off control #3758
- Gracefully handle MIDI overflow #825

## Other

- Add CMake build system with `ccache` and `sccache` support for faster compilation times and remove SCons #2280 #3618
- Make Mixxx compile even though `QT_NO_OPENGL` or `QT_OPENGL_ES_2` is defined (fixes build on Raspberry Pi) lp:1863440 #2504
- Fix ARM build issues #3602
- Fix missing manual in DEB package lp:1889776 #2985
- Add macOS codesigning and notarization to fix startup warnings #3281
- Don't trash user configuration if an error occurs when writing #3192
- Enable CUE sheet recording by default #3374
- Fix crash when double clicking GLSL waveforms with right mouse button #3904
- Derive Mixxx version from `git describe` #3824 #3841 #3848
- Improve tapping the BPM of a deck #3790 lp:1882776
- And countless other small fixes and improvements (too many to list them all!)

## 16.8.4 2.2.4 (2020-06-27)

- Store default recording format after «Restore Defaults» lp:1857806 #2414
- Prevent infinite loop when decoding corrupt MP3 files #2417
- Add workaround for broken libshout versions #2040 #2438
- Speed up purging of tracks lp:1845837 #2393
- Don't stop playback if vinyl passthrough input is configured and PASS button is pressed #2474
- Fix debug assertion for invalid crate names lp:1861431 #2477
- Fix crashes when executing actions on tracks that already disappeared from the DB #2527
- AutoDJ: Skip next track when both deck are playing lp:1399974 #2531
- Tweak scratch parameters for Mixtrack Platinum #2028
- Fix auto tempo going to infinity on Pioneer DDJ-SB2 #2559
- Fix bpm.tapButton logic and reject missed & double taps #2594
- Add controller mapping for Native Instruments Traktor Kontrol S2 MK3 #2348
- Add controller mapping for Soundless joyMIDI #2425

- Add controller mapping for Hercules DJControl Inpulse 300 #2465
- Add controller mapping for Denon MC7000 #2546
- Add controller mapping for Stanton DJC.4 #2607
- Fix broadcasting via broadcast/recording input lp:1876222 #2743
- Only apply ducking gain in manual ducking mode when talkover is enabled lp:1394968 lp:1737113 lp:1662536 #2759
- Ignore MIDI Clock Messages (0xF8) because they are not usable in Mixxx and inhibited the screensaver #2786

### 16.8.5 2.2.3 (2019-11-24)

- Don't make users reconfigure sound hardware when it has not changed #2253
- Fix MusicBrainz metadata lookup lp:1848887 #2328
- Fix high DPI scaling of cover art #2247
- Fix high DPI scaling of cue point labels on scrolling waveforms #2331
- Fix high DPI scaling of sliders in Tango skin #2318
- Fix sound dropping out during recording lp:1842679 #2265 #2305 #2308 #2309
- Fix rare crash on application shutdown #2293
- Workaround various rare bugs caused by database inconsistencies lp:1846971 #2321
- Improve handling of corrupt FLAC files #2315
- Don't immediately jump to loop start when loop\_out is pressed in quantized mode lp:1837077 #2269
- Preserve order of tracks when dragging and dropping from AutoDJ to playlist lp:1829601 #2237
- Explicitly use X11 Qt platform plugin instead of Wayland in .desktop launcher lp:1850729 #2340
- Pioneer DDJ-SX: fix delayed sending of MIDI messages with low audio buffer sizes #2326
- Enable modplug support on Linux by default lp:1840537 #2244 #2272
- Fix keyboard shortcut for View > Skin Preferences lp:1851993 #2358 #2372
- Reloop Terminal Mix: Fix mapping of sampler buttons 5-8 lp:1846966 #2330

### 16.8.6 2.2.2 (2019-08-10)

- Fix battery widget with upower <= 0.99.7. #2221
- Fix BPM adjust in BpmControl. lp:1836480
- Disable track metadata export for .ogg files and TagLib 1.11.1. lp:1833190
- Fix interaction of hot cue buttons and looping. lp:1778246
- Fix detection of moved tracks. #2197
- Fix playlist import. #2200 lp:1687828
- Fix updating playlist labels. lp:1837315
- Fix potential segfault on exit. lp:1828360
- Fix parsing of invalid BPM values in MP3 files. lp:1832325

- Fix crash when removing rows from empty model. #2128
- Fix high DPI scaling of RGB overview waveforms. #2090
- Fix for OpenGL SL detection on macOS. lp:1828019
- Fix OpenGL ES detection. lp:1825461
- Fix FX1/2 buttons missing Mic unit in Deere (64 samplers). lp:1837716
- Tango64: Re-enable 64 samplers. #2223
- Numark DJ2Go re-enable note-off for deck A cue button. #2087
- Replace Flanger with QuickEffect in keyboard mapping. #2233

### 16.8.7 2.2.1 (2019-04-22)

- Include all fixes from Mixxx 2.1.7 and 2.1.8
- Fix high CPU usage on MAC due to preview column lp:1812763
- Fix HID controller output on Windows with common-hid-packet-parser.js
- Fix rendering slow down by not using QPainter in WSpinny lp:1530720
- Fix broken Mic mute button lp:1782568
- added quick effect enable button to the control picker menu
- Fix Cover Window close issue with empty cover arts
- Fix Numark Mixtrack 3 mapping. #2057

### 16.8.8 2.2.0 (2018-12-17)

#### General

- Update from Qt4 to Qt5.
- Use Qt5's automatic high DPI scaling (and remove the old scaling option from the preferences).
- Vectorize remaining raster graphics for better HiDPI support.

#### Effects

- Add mix mode switch (Dry/Wet vs Dry+Wet) for effect units.
- Add support for LV2 effects plugins (currently no way to show plugin GUIs).
- Add preference option for selecting which effects are shown in the list of available effects in the main window (all LV2 effects are hidden by default and must be explicitly enabled by users).

## Skins

- Add 8 sampler and small sampler options to LateNight.
- Add key / BPM expansion indicators to Deere decks.
- Add skin settings menu to LateNight.

## Controllers

- Add controller mapping for Numark Mixtrack Platinum.
- Update controller mapping for Numark N4.
- Add spinback and break for Vestax VCI-400 mapping.

## Miscellaneous

- Add preference option to adjust the play position marker of scrolling waveforms.
- Add preference option to adjust opacity of beatgrid markers on scrolling waveforms.
- Support IRC/AIM/ICQ broadcast metadata.

### 16.8.9 2.1.8 (2019-04-07)

- Fix a rare chance for a corrupt track file while writing metadata in out of disk situations. [lp:1815305](#)
- Fix export of BPM track file metadata. [lp:1816490](#)
- Fix sending of broadcast metadata with TLS enabled libshout 2.4.1. [lp:1817395](#)
- Fix resdiscovering purged tracks in all cases. [lp:1821514](#)
- Fix dropping track from OSX Finder. [lp:1822424](#)

### 16.8.10 2.1.7 (2019-01-15)

- Fix syncing to doublespeed [lp:1808697](#)
- Fix issues when changing beats of a synced track [lp:1808698](#)
- Fix direction of pitch bend buttons when inverting rate slider [lp:1770745](#)
- Use first loaded deck if no playing deck is found [lp:1784185](#)
- Encode file names correctly on macOS [lp:1776949](#)

### 16.8.11 2.1.6 (2018-12-23)

- Fix crash when loading a Qt5 Soundsource / Vamp Plug-In. lp:1774639
- Validate effect parameter range. lp:1795234
- Fix crash using the bpm\_tap button without a track loaded. lp:1801844
- Fix possible crash after ejecting a track. lp:1801874
- Fix wrong bitrate reported for faulty mp3 files. lp:1782912
- Fix Echo effect syncing lp:1793232
- Fix iTunes context menu lp:1799932
- Fix loading the wrong track after delete search and scroll. lp:1803148
- Improve search bar timing. lp:1635087
- Fix quoted search sentence. lp:1784141
- Fix loading a track formerly not existing. lp:1800395
- Fix importing m3u files with blank lines. lp:1806271
- Fix position in sampler overview waveforms. lp:1744170
- Don't reset rate slider, syncing a track without a beatgrid. lp:1783020
- Clean up iTunes track context menu. lp:1800335
- Collapsed sampler are not analyzed on startup. lp:1801126
- search for decoration characters like «°». lp:1802730
- Fix cue button blinking after pressing eject on an empty deck. lp:1808222

### 16.8.12 2.1.5 (2018-10-28)

- Code signing for Windows builds. lp:1517823
- Fix crash on exit when preferences is open. lp:1793185
- Fix crash when analyzing corrupt MP3s. lp:1793387
- Fix crash when importing metadata from MusicBrainz. lp:1794993
- Library search fixes when single quotes are used. lp:1784090 lp:1789728
- Fix scrolling waveform on Windows with WDM-KS sound API. lp:1729345
- Fix right clicking on beatgrid alignment button in Tango and LateNight skins. lp:1798237
- Improve speed of importing iTunes library. lp:1785545
- Add 2 deck mapping for DJTechTools MIDI Fighter Twister.

### 16.8.13 2.1.4 (2018-08-29)

Fix track selection not getting shown in the track table on Windows. There are no changes to the source code, but the Jenkins build configuration was changed to delete the Jenkins workspace before each build. [lp:1751482](#)

### 16.8.14 2.1.3 (2018-08-20)

Fix a severe performance regression on Windows: [Mixxx 2.1.2 running much slower than 2.1.1](#)

### 16.8.15 2.1.2 (2018-08-10)

Yet another bugfix release of Mixxx 2.1. Here is a quick summary of what is new in Mixxx 2.1.2:

- Allow maximum deck speed of 4x normal.
- Don't always quantize hotcues, a 2.1.1 regression. [lp:1777429](#)
- Fix artifacts using more than 32 samplers. [lp:1779559](#)
- store No EQ and Filter persistently. [lp:1780479](#)
- Pad unreadable samples with silence on cache miss. [lp:1777480](#)
- Fixing painting of preview column for Qt5 builds. [lp:1776555](#)
- LateNight: Fix play button right click. [lp:1781829](#)
- LateNight: Added missing sort up/down buttons.
- Fix sampler play button tooltips. [lp:1779468](#)
- Shade: remove superfluid margins and padding in sampler.xml. [lp:1773588](#)
- Deere: Fix background-color code.
- iTunes: Don't stop import in case of duplicated Playlists. [lp:1783493](#)

### 16.8.16 2.1.1 (2018-06-13)

After two months it is time to do a bugfix release of Mixxx 2.1. Here is a quick summary of what is new in Mixxx 2.1.1:

- Require Soundtouch 2.0 to avoid segfault. [lp:1577042](#)
- Improved skins including library view fix. [lp:1773709](#) [lp:1772202](#) [lp:1763953](#)
- Fix crash when importing ID3v2 APIC frames. [lp:1774790](#)
- Synchronize execution of Vamp analyzers. [lp:1743256](#)
- DlgTrackInfo: Mismatching signal/slot connection.
- Detect M4A decoding errors on Windows. [lp:1766834](#)
- Fix spinback inertia effect.
- Fix decoding fixes and upgrade DB schema. [lp:1766042](#) [lp:1769717](#)
- Fix integration of external track libraries. [lp:1766360](#)
- Fix memory leak when loading cover art. [lp:1767068](#)
- Fix clearing of ReplayGain gain/ratio in file tags. [lp:1766094](#)



- Fix crash when removing a quick link. [lp:1510068](#)
- Fdlib: Thread-safe and reentrant generation of filters. [lp:1765210](#)
- Fix unresponsive scrolling through crates & playlists using encoder. [lp:1719474](#)
- Swap default values for temp/perm rate changes. [lp:1764254](#)

### 16.8.17 2.1.0 (2018-04-15)

After two years of hard work, we are pleased to announce Mixxx 2.1. We have overhauled the effects system, redesigned the skins, added and improved lots of controller mappings, rewrote the audio file decoders twice, and of course fixed a bunch of bugs. Download it!

Here is a quick summary of what is new in Mixxx 2.1.0:

- Graphical interface scales for high resolution screens
- Overhauled Deere and LateNight skins
- New Tango skin
- Effects are synchronized to the tempo
- Effects are processed post-fader and post-crossfader and can be previewed in headphones
- One metaknob per effect with customizable parameter control for intuitive use of effect chains
- Nine new effects: Autopan, Biquad Equalizer, Biquad Full Kill Equalizer, Loudness Contour, Metronome, Parametric Equalizer, Phaser, Stereo Balance, Tremolo
- Loaded effects and their parameters are saved and restored when Mixxx restarts
- More transparent sounding equalizers (Biquad Equalizer and Biquad Full Kill Equalizer)
- Improved scratching sounds with jog wheels, vinyl control, and dragging waveforms with the mouse
- Simplified looping and beatjump controls
- Configurable rows of 8 samplers with up to 8 rows available for a total of 64 samplers
- Files loaded to samplers are reloaded when Mixxx restarts
- Improved volume normalization algorithm (EBU-R 128)
- Filter library table by crates
- Sort musical keys in library table by circle of fifths
- Write metadata tags back to audio files
- New JavaScript library for controller mapping
- Configure multiple Internet broadcasting stations and use multiple stations at the same time
- Broadcast and record microphones with direct monitoring and latency compensation
- Broadcast and record from an external mixer
- Booth output with independent gain knob for using sound cards with 6 output channels without an external mixer
- Prevent screensaver from starting while Mixxx is running
- CUP (Cue And Play) cue button mode
- Time remaining and time elapsed now take into account the tempo fader
- Clicking cover art now shows it full size in a separate window

- and of course, lots and lots of bug fixes.

Here are controllers with mappings that have been added or updated since the 2.0 release. Mappings marked with an asterisk (\*) have been updated for the new effects interface:

- American Audio VMS2
- American Audio VMS4
- Allen & Heath Xone K2/K1\*
- Behringer CMD Micro
- Behringer CMD MM1\*
- Behringer CMD Studio 4a
- Denon MC4000\*
- Denon MC6000 Mk2\*
- FaderFox DJ2
- Hercules DJ Console 4-Mx\*
- Hercules DJ Control MP3 LE / Glow
- Hercules DJ Control Compact
- Hercules P32\*
- Ion Discover DJ
- Korg Nanokontrol 2
- Korg KAOSS DJ
- M-Audio Xponent
- Native Instruments Traktor Kontrol S4 Mk2\*
- Novation Launchpad Mk1 & Mk2
- Novation Twitch
- Numark Mixtrack Pro 3 & Numark Mixtrack 3\*
- Pioneer DDJ-SB2\*
- Pioneer DDJ-SX\*
- Reloop Beatmix 2
- Reloop Beatmix 4
- Reloop Digital Jockey 3 ME
- Reloop Terminal Mix 2
- Reloop Terminal Mix 4
- Vestax VCI-100 Mk2
- Vestax Typhoon

For users upgrading from older versions of Mixxx, we have a few important announcements. First, if you are using Windows, you will have to uninstall any old versions of Mixxx before you can install 2.1. How to uninstall Mixxx varies on different versions of Windows:

- Windows Vista, 7, and 8: [Start > Control Panel > Programs > Uninstall a Program](#)

- Windows 10: [Start > Control Panel > Programs > Programs And Features > look for Mixxx > Uninstall](#)

If you are upgrading from an older version of Mixxx and have MP3 files in your library, we have another important announcement. The good news is that we fixed a bug where the waveforms and audio playback of MP3 files were mis-aligned. The bad news is that we have no way of knowing which MP3 files were affected or how much the offset was. That means that waveforms, beatgrids, cues, and loops from older versions of Mixxx may be offset by an unknown amount for any MP3 file. Only MP3 files were affected by this bug; other audio file types are unaffected. You can either correct your beatgrids and cue points manually for each track, or you can clear this information for all MP3s and start fresh. Regardless, we recommend clearing the waveforms for all MP3 files. To clear these, type «location:mp3» into the library search bar, press Control + A to select all tracks, right click, and select the information you want to clear from the menu.

In the works for Mixxx 2.2, we have a big redesign of the library GUI. Along with that will come saving & restoring search queries plus nested crates. We are also planning on adding support for saving and loading custom effect chain presets with the ability to import and export them to share online.

Want to help make Mixxx even more awesome? The biggest thing we need is more people. You do not need to be a programmer to help out. Giving feedback on the design of new features as they are being made is very valuable. Refer to the Testing page on the wiki for more information on how to get involved with that. Reporting bugs and telling us your ideas on the Launchpad bug tracker is a big help too! We cannot fix problems we do not know about, so please let us know if you find any issues with Mixxx. If you would like to help translate Mixxx into another language, refer to the Internationalization wiki page. Of course, more programmers could always help. Read the Developer Documentation on the wiki for tips on getting started contributing code to Mixxx.

We hope you have as much fun with Mixxx as we do!

For a full list of new features and bugfixes, check out the [2.1.0 milestone on Launchpad](#).

### **16.8.18 2.0.0 (2015-12-31)**

- 4 Decks with Master Sync
- New Effects Framework with 4 Effect Units and 5 Built-in Effects:
  - Flanger, Bit Crusher, Reverb, Echo, Filter
  - More to come!
- Configurable, Resizeable User Interface with 3 Brand New Skins
- Cover Art Display
- Music Key Detection and Shifting
- Vinyl Audio Pass-Through
- 4 Microphone inputs and 4 Auxiliary inputs
- MIDI Mapping GUI and Improved Learning Wizard
- MusicBrainz metadata fetching
- RGB Musical Waveforms
- Hundreds of Bug Fixes and Improvements
- New Pitch-Independent Algorithm for Better-Sounding Key-lock

For a full list of new features and bugfixes, check out the [2.0.0 milestone on Launchpad](#).

#### **Vedi anche:**

For an overview of previous versions, [take a look at the timeline](#).

### 17.1 Controllers

Mixxx supports the following *controllers* out of the box. Additional third-party controller mappings that were contributed by the community (but are not yet included in Mixxx) can be found at Mixxx” [Controller Mapping Forum](#).

**Vedi anche:**

*Using MIDI/HID Controllers* describes how to configure Mixxx to use controllers.

#### 17.1.1 Akai LPD8

- [Manufacturer’s product page](#)
- [Forum thread](#)

Nuovo nella versione 1.10.1.

---

**Nota:** Unfortunately a detailed description of this controller mapping is still missing. If you own this controller, please consider [contributing one](#).

---

#### 17.1.2 Akai MPD24

- [Manufacturer’s product page](#)
- [Forum thread](#)

Nuovo nella versione 1.8.

**Nota:** Unfortunately a detailed description of this controller mapping is still missing. If you own this controller, please consider [contributing one](#).

### 17.1.3 Allen & Heath Xone:K2

The Allen & Heath Xone:K2 is a flexible controller that is mapped to control Mixxx’s decks, effects, or both. It has an integrated 4 channel audio interface with 2 RCA jacks and an 1/8» stereo headphone jack. The Xone K1 is the same as the Xone K2 but without the built in audio interface and does not come with the EVA travel case that the K2 comes with.

- [Manufacturer’s product page](#)
- [Forum thread](#)
- [Manufacturer’s User Guide](#)
- [Blank template diagrams](#)

Nuovo nella versione 1.11.

#### Audio Setup

The Xone:K2 is setup in Mixxx > Preferences > Sound Hardware > Output

| Output     | Device  | Channel       |
|------------|---------|---------------|
| Master     | XONE:K2 | Channel 3 - 4 |
| Headphones | XONE:K2 | Channel 1 - 2 |

Note: This Channel setup is the opposite of what most DJ controllers with an integrated audio interface use. The design choice to not use Channel 1 - 2 for Master Output is known to cause problems, when users want to use the Xone:K2 as default system audio output as the operating system will always use Channel 1 - 2. Thus system audio will go to the headphones.

There are no hardware controls for the volume so they are always at max volume. Adjusting the volume of master and headphone outputs is done by adjusting the gain for those outputs in Mixxx using the controller mapping.

#### Setup

**Requirement:** The Xone K2 must have Latching Layers turned off, which is the default. Refer to the [Xone K2 manual](#) page 12 for details. The K1 does not have Latching Layers.

This mapping can used with one or multiple Xone K2s/K1s. Multiple Xone K2s/K1s can be connected to each other via X-Link with one of them connected to the computer via USB. Alternatively, when using 2 K2s/K1s, they can both be connected with their own USB cable and this same mapping can be loaded for each.

The layout of the mapping depends on the configured MIDI channel of the controller. Change the MIDI channel of the controller by pressing the bottom right encoder (labeled “Power On Setup/Scroll/Set”) while plugging in the controller. Scroll with the encoder to select a MIDI channel. The letter in parentheses corresponds to the last lit button when selecting the channel:

- Channel 15 (O, default out of the box): two decks + two effect units with decks in the middle
- Channel 14 (N): two decks + two effect units with effect units in the middle
- Channel 13 (M): two decks + two effect units with decks on left

- Channel 12 (L): two decks + two effect units with decks on right
- Channel 11 (K): four decks ordered 3 1 2 4
- Channel 10 (J): four decks ordered 1 2 3 4
- Channel 9 (I): four effect units ordered 3 1 2 4
- Channel 8 (H): four effect units ordered 1 2 3 4

## Global Controls

These are available on any configuration with decks, but not the 4 effect unit layout.

- Bottom left encoder:
  - adjust tempo of all decks with sync enabled
  - press and turn: PFL/master mix in headphones
  - shift: headphone gain
  - press with shift: toggle split cue mode
- Bottom right encoder
  - scroll through tracks in library
  - press and release: load selected track into first stopped deck
  - press and hold: load selected track into a deck by pressing the play button of the deck
  - shift: master gain

## Decks

The bottom right button is the shift button. The bottom left button toggles the bottom button grid between a loop layer (amber) and a hotcue layer (red). Holding shift then holding the bottom left layer button at the same time activates supershift mode.

- Top encoder: jog
  - shift: gain
  - supershift: adjust key
- Top encoder press: reset gain
  - shift: master sync
  - supershift: reset key
- Knobs: high/mid/low equalizer knobs
- Top button 1: headphones/PFL
  - shift: reset tempo
  - supershift: set beatgrid to current position
- Top button 2: cue
  - shift: go to beginning of track and stop
  - supershift: keylock

- Top button 3: play
  - shift: reverse
  - supershift: quantize
- Fader: volume
- Bottom buttons (intro/outro cue layer, amber): Intro/outro cues from top to bottom are ordered: - Intro start - Intro end - Outro start - Outro end
  - press: jump to that cue or sets it if it is not set
  - shift: seek forward/back. The top two (intro) buttons seek quickly; the bottom two (outro) seek slowly
  - supershift: delete cue
- Bottom buttons (hotcue layer, red): Hotcues are ordered 1-4 from top to bottom
  - press: jump to that hotcue or sets it if it is not set
  - shift: seek forward/back. The top two buttons seek quickly; the bottom two seek slowly
  - supershift: delete hotcue
- Bottom buttons (loop layer, green):
- Bottom button 1 (red): reloop/disable loop
  - shift: jump to to beginning of loop, stop playback, and activate loop
  - supershift: set loop in point. Hold to move loop in point with play position.
- Bottom button 2 (green): activate loop of selected size
  - shift: activate rolling loop of selected size
  - supershift: set loop out point. Hold to move loop out point with play position.
- Bottom button 3 (amber): double loop size
  - shift: beatjump forward by selected size if no loop is enabled. If loop is enabled, move the loop forward by the beatjump size.
  - supershift: double beatjump size
- Bottom button 4 (amber): halve loop size
  - shift: beatjump backward by selected size if no loop is enabled. If loop is enabled, move the loop backward by the beatjump size.
  - supershift: halve beatjump size

## Effects

The top part of the column uses the [Standard Effects Mapping](#). Pressing the top encoder acts as the effect focus button. When no effect is focused, the buttons are red. When holding the top encoder to choose an effect to focus, the buttons are green. When an effect is focused, the buttons are amber.

The fader acts as the mix knob.

The bottom buttons assign the effect unit to different input channels and light up red. On the two deck layouts, from top to bottom, they assign the effect unit to deck 1, deck 2, master mix, and headphones. On the four effect unit layouts, they assign the effect unit to decks 1-4 going down the column. You can look down a column to see which decks an effect unit is assigned. You can look across a row to see which effect units are assigned to a deck. When shift is pressed, the bottom two buttons switch to controlling the routing buttons for the master and headphones channels and light up amber.

The bottom encoders are not mapped in the 4 effect unit layout.

## Effect unit focusing

In addition to focusing one effect in a unit at a time with the [Standard Effects Mapping](#), the Xone K2/K1 has another mode for focusing a whole effect unit. This allows for controlling the parameters of all 3 effects in the unit at a time. This mode is only available on the 4 effect unit layouts. To access it, press the Layer button in the bottom left. Press one of the top encoders to choose which effect unit to focus.

In this mode, each horizontal row of knobs and buttons controls one effect. The knobs control the parameters of the effects. Turning any of the knobs with shift loads different effects. The button in the leftmost column controls the enable button of the effect and turns amber when it is on. The rest of the buttons control the button parameters of the effect and turn green when active (not all effects have button parameters). The faders still control the dry/wet knobs and the bottom button grid still controls the routing buttons.

To get back to controlling all 4 effect units, press the Layer button again. The next time Layer is pressed, the effect unit that was focused before will be remembered (but it will not be remembered after restarting Mixxx).

## Troubleshooting

If general functionality or supershift are not working, double check that Latch Layers is turned off and MIDI CH is selected. Refer to the [Xone K2 manual](#) page 12 for details.

## Known Issues

There are a few known issues with the Xone K2/K1 firmware:

- Since there is no way for Mixxx to ask the controller about the positions of all the knobs and faders when Mixxx starts, they are out of sync with the state of Mixxx until they are first moved.
- When the USB connection is interrupted and the controller stays powered on, such as leaving the controller plugged into a powered USB hub and disconnecting the hub from the computer, the controller will not send MIDI input until it is powered down (unplugged) and plugged back in.

If you would like these issues to be fixed, please let [Allen & Heath Support](#) know.

### 17.1.4 American Audio Radius 2000

A CD and USB media player that can control Mixxx over USB with MIDI. It can also play timecode from CDs or USB drives which can control Mixxx when they are connected by a sound card.

- [Manufacturer's product page](#)

Nuovo nella versione 1.10.

---

**Nota:** Unfortunately a detailed description of this controller mapping is still missing. If you own this controller, please consider [contributing one](#).

---



### 17.1.5 American Audio VMS2

The American Audio VMS2 is a 2-deck all-in-one controller. It is a USB class compliant MIDI and audio device that works with GNU/Linux, Mac OS X, and Windows. It features a 4 channel input and 4 channel output sound card with 2 phono preamps. The main output has XLR and RCA outputs (do not use both at once). There is a separate RCA booth output. The VMS2 can also be used as a stand-alone mixer with analog sources without a computer by setting the USB/Analog switches on the front of the device to “Analog”.

- [Manufacturer’s product page](#), provides manual and drivers for download.
- [Forum thread](#), for discussion of mapping options.
- [Pull Request](#), which this wiki page describes.

Nuovo nella versione 1.11.

#### Audio Setup

No driver needs to be installed on GNU/Linux or Mac OS X. However, on Windows, it is recommended to install the driver from the manufacturer to be able to use the *ASIO sound API*.

Unlike most controllers with built in sound cards, which rely on Mixxx to do all mixing in software, the VMS2 mixes signals from the sound card in hardware. To use it with Mixxx:

- Bypass the built-in hardware equalizer of the VMS2 (i.e. use Post-EQ Mode). Hold the forward search button on the right deck as you turn the VMS2 on to switch between Post-EQ and Pre-EQ modes. See section 15 of the [manufacturer’s manual](#) for details.
- Set the USB/Analog switches on the front side of the VMS2 to “USB”
- In Mixxx’s Sound Hardware Preferences:
  - Set the sample rate to 48000 Hz
  - Select channels 1-2 for Deck 1 output
  - Select channels 3-4 for Deck 2 output

*Note:* You cannot use the preview deck to pre-listen in this setup, as Mixxx routes the preview deck to Mixxx’s headphone output, which is not mixed with the Deck 1/2 outputs. You could use a separate soundcard and route the headphone output there to also pre-listen using the preview deck. Of course, if you do so, attach the headphones to that other soundcard instead of the VMS2.

#### Input and Recording

The analog inputs are captured by the built-in soundcard as input signals. They can be used for timecode signals (e.g. time-code vinyl), as the VMS2 also features built-in phono preamps. *FIXME* I did not try that, please verify!

The microphone input is mixed directly into the master output signal of the VMS2 in hardware and cannot be captured through software. If you want to record voice over using the Mixxx software, you will need a different solution. You can use a separate microphone attached to the computer, but that signal will not be routed to the VMS2 and therefore not be on the VMS2 master output (but in the Mixxx recording from the software master/record output).

Mixxx’s Deck 1/2 outputs are affected by the Mixxx software EQs. However, the VMS2’s volume faders and crossfader (as well as the headphone buttons) control the VMS2’s hardware mixer and do not affect Mixxx’s Deck 1 and Deck 2 output signals. Therefore, a recording using the Mixxx software will sound different from what is played through the VMS2 master output, as the crossfader curve and signal mixing are not the same in hardware and software. If you require a recording that captures exactly what the audience will hear, use a separate soundcard and recording software to record from the VMS2 booth output.

## Mapping description

### Mixer section

All main functions are mapped straightforwardly:

| VMS2 Control   | Mixxx Control          |
|----------------|------------------------|
| Crossfader     | Crossfader             |
| Volume Fader   | Volume Fader           |
| Cue (PFL)      | PFL                    |
| Cue Mix        | Cue Mix (PFL / Master) |
| Headphone Gain | Headphone Gain         |
| Channel Gain   | Channel Gain           |
| Master Gain    | Master Gain            |

As noted in the *#Audio Setup* section, these control the VMS2's hardware mixer. Although the state of the controls is reflected on screen in Mixxx, the actual mixing is done by the VMS2's hardware mixer.

### Deck Control

Deck control is straightforward, too:

| VMS2 Control          | Mixxx Control                                   |
|-----------------------|---|
| Play                  | Toggle deck play/pause                          |
| Pause                 | Pause the deck                                  |
| Cue                   | Cue Point (configure behavior in software)      |
| Pitch +/-             | Temporary pitch bend +/-                        |
| Pitch Fader           | Pitch Fader                                     |
| Range (Shift+Sync)    | Cycle pitch fader range (+-8/10/30/100%)        |
| Sync                  | Sync to other deck                              |
| Search <</>>          | Search through currently loaded track           |
| Keylock (Shift+Vinyl) | Toggle pitch independent time stretch (KeyLock) |
| Vinyl                 | Toggle between Scratch mode and Pitch mode      |
| Platter               | Touch sensitive platters! Scratch or Pitchbend  |
| Shift + Platter       | Scroll through library quickly                  |

In Pitch mode, moving the platters from either the top or side will only bend the pitch of the deck. In Scratch mode, the platters act like vinyl turntables and can be used for scratching. Touching and holding them from the top stops the deck. Moving them from the edge does not stop the deck.

### Library and Track loading

Use the encoder in the center of the controller to browse through the library. Press the encoder to switch between library main window and sidebar. Unfortunately there seems to be no way to expand entries in the sidebar through the controller script.

Use the [LOAD] buttons to load the currently selected track into either the left or right deck.

The four directional buttons around the knob also control the library:

| Button | Library function       |
|--------|------------------------|
| Up     | Previous library entry |
| Down   | Next library entry     |
| Left   | Previous sidebar entry |
| Right  | Next sidebar entry     |

If you hold Shift and then rotate a platter, you can scroll through the library much faster.

## Equalizer

The per deck EQ rotaries are mapped to their software counterparts. The VMS2 has no dedicated kill switches for the EQ. However, in Mixxx, pressing the following buttons with Shift acts as EQ kill switches.

| VMS2 Control | Mixxx Control    |
|--------------|------------------|
| Shift+IN     | Kill Switch Low  |
| Shift+OUT    | Kill Switch Mid  |
| Shift+RELOOP | Kill Switch High |

## Hotcues

The VMS2 can control 6 hotcues per deck.

| VMS2 Control                                    | Mixxx Control             |
|---|---------------------------|
| 1 / 2 / 3                                       | Set/Jump HotCue 1 / 2 / 3 |
| Vinyl + 1 / 2 / 3                               | Delete HotCue 1 / 2 / 3   |
| 4 / 5 / 6 = (Shift + 1 / 2 / 3)                 | Set/Jump HotCue 4 / 5 / 6 |
| Vinyl + 4 / 5 / 6 = (Vinyl + Shift + 1 / 2 / 3) | Delete HotCue 4 / 5 / 6   |

Pressing the vinyl/keylock button will not toggle scratch mode or keylock as long as a hotcue is deleted before releasing the vinyl/keylock button.

## Loops

| VMS2 Control         | Mixxx Control                             |
|----------------------|---|
| IN                   | Mark beginning of loop                    |
| OUT                  | Mark end of loop                          |
| RELOOP               | Leave / Reenter current loop              |
| LOOP                 | Start a 4 Beat loop from current position |
| Smart (Shift + Loop) | Toggle quantize                           |
| (:2) / (*2)          | Halve or double the current loop length   |

As Mixxx currently only supports one active loop per deck, the secondary loop controls have been remapped to EQ kill switches.

## 17.1.6 American Audio VMS4/4.1

The original VMS4 has problems with sound quality. The microphone input impedance is off and the output volume is low. The VMS4.1 is the same controller, except that those hardware issues have been fixed. The Traktor edition has different labels on some buttons & knobs, but it's otherwise the same hardware as the VMS4.1.

- VMS4
- VMS4.1
- VMS4.1 Traktor edition

Nuovo nella versione 1.9.

### Setup

---

**Nota:** Mixxx expects the VMS4 to be set to “Post EQ” mode for best sound quality. Do this by holding down the Headphone Cue button on Midilog 4 while powering on the unit. You only need to do this once. (Each time you do, it changes the mode back and forth.) Consult the [user manual](#) for more information.

To check the status of this in Linux, at a console, issue the command `lsusb -v|grep 'iSerial\||iProduct'` and look at the serial number under the VMS4 device per the instructions in the user manual. As of this writing, the leading digit should be **1**.

---

1. Make sure the VMS4 is off
2. Slide the switch on the front of the VMS4 to “8 OUT”
  - If you're using vinyl control or aux devices (or Mixxx 1.11 & below) set the switch to “4 OUT” for 2-deck output and 2-deck input
3. Turn on the unit (and plug in the USB cable if you haven't yet)
4. Start Mixxx
5. Open Preferences
6. Click Sound Hardware. In the right pane:
  1. Set the sample rate to **44100Hz**
  2. Set the Master output to **None**
  3. Set the Headphone output to **None**
  4. Set the Deck 1 output to the **VMS4** device and **Channel 3-4** (may show as “USB Audio Device” on Windows)
  5. Set the Deck 2 output to the **VMS4** device and **Channel 5-6**
  6. Set the Deck 3 output to the **VMS4** device and **Channel 1-2**
  7. Set the Deck 4 output to the **VMS4** device and **Channel 7-8**
    - If you're using 4 OUT mode, (for vinyl control/aux input or Mixxx 1.11 & below):
      1. Set the Deck 1 output to the **VMS4** device and **Channel 1-2**
      2. Set the Deck 2 output to the **VMS4** device and **Channel 3-4**
      3. For vinyl control, set the Vinyl Control 1 input to the **VMS4** device and **Channel 1-2**, connect a turntable to Midilog 1, and set it to Analog.

4. For vinyl control, set the Vinyl Control 2 input to the **VMS4** device and **Channel 3-4**, connect a turntable to Midilog 4, and set it to Analog.
7. Plug your headphones into the VMS4's jack on the front. You will use the VMS4's CUE buttons and knobs for headphone control.
8. Still in the Preferences, expand "Controllers" on the left
9. Select the "VMS4 MIDI" device (may show as "USB Audio Device" on Windows)
  - Do not choose the the HID one. That's for the little mouse pad and button area.
10. Click the Enable checkbox in the right pane
11. Click the drop-down and choose the *American Audio VMS4* preset
12. Click OK and the controller should light up. (In 1.9.x, the controller will light up when you load a track to a deck.)
13. Continue reading below to know how everything is mapped

## Direct deck output implications

This setup uses direct deck outputs because mixing takes place in the VMS4 hardware. The down side to this is that you won't be able to use Mixxx features that play to Master or Cue buses like the Preview Deck or Samplers. Using these features with a hardware + MIDI mixer like the VMS4 is not really feasible unless you used a separate sound interface or controlled Mixxx's internal mixer another way.

## Control

This guide explains how the VMS4 is mapped by default in Mixxx.

**Easy customization:** We have provided the following customization variables at the top of the script you can set to your liking:

1. **RateRanges:** Set the pitch slider range each time you toggle it with Shift+Sync.

Just open the `midi/American-Audio-VMS4-scripts.js` file in your favorite text editor (Wordpad works too) and you'll see these variables right near the top. Edit & save, then restart Mixxx and enjoy.

## Deck controls

---

**Nota:** There are a number of different face plates in the wild so these images and control descriptions may not exactly match yours. The locations of the controls are the key things to pay attention to.

---

*The controls are the same on both sides of the controller. The left side controls Deck 1 and the right side controls Deck 2.*

- **Sync/Range** button - Changes the BPM of this deck to match that of the other. When shifted, toggles the pitch slider range. (See top of page to customize.)
- **Hot cue buttons** - Press to set or recall a hot cue. The buttons light up red when one is set. Hold Shift and press to access hot cues 5-8. (The buttons light up blue for these.) Hold Vinyl and press to delete the cue. (Note: there is a bug in some firmware versions that causes hot cues 5 and 6 to be deleted simultaneously.) the cue.
- **Pitch Bend +/-**
- Momentarily speeds up or slows down the deck while the button is held down.
- Hold Shift and press to adjust the key (pitch) of the song (independent of the tempo.)

- **Loop In** - Set the in point of a loop
- **Loop Out** - Set the out point of a loop
- **Reloop** - Toggle a previously-set loop. Lights red when a loop is active.
- **Loop/Smart** Start a 4-beat loop. Hold Shift and press to toggle quantization (locking to the nearest beat.)
- **Vinyl/Keylock** - (*Does nothing on its own when un-shifted at the moment.*) When shifted, toggles key lock.
- **<< Search/ /2** - Fast-rewind Hold Shift and press to halve the current loop length
- **Search >>/ \*2** - Fast-forward Hold Shift and press to double the current loop length
- **Touch strip** Scroll through the respective Library panes. (Left for the folders/crates list, right for the track list.) Hold Shift and touch: - to affect the Dry/Wet knob on the respective effect unit while the deck is playing - for Needle drop - search through the track while the deck is stopped
- **Wheel** Move the wheel while touching the top to scratch the current track like a vinyl record Move the wheel without touching the top (so on the sides) to perform a temporary pitch bend
- **CUE** - Operates according to the Cue mode set in Mixxx's preferences Hold Shift and press to play immediately from the cue point (known as Cue+Play or CUP.)
- **Play** - Press to toggle deck playback Hold Shift and press to set this deck as the master for syncing with another
- **Pause** - Stops the deck playback

## Effects section

The left side controls effect unit 1 and the right side controls effect unit 2.

- **Select knob**
  - Rotate to choose the effect chain preset
  - Press to toggle whether the effect unit is on or not
- **Control knob**
  - Adjusts the wet/dry ratio
  - When Parameter is on, this becomes the Wonder Knob, adjusting all effect parameters at once
  - **On/Off** - Toggles the effect for the deck matching the effect unit number
  - **Parameter** - Toggles what the above Control knob adjusts

## Sample section

The left side of the controller controls Sampler 1, and the right, Sampler 2.

- **Select knob** Rotate to move the highlight in the library. Press to load the currently highlighted track into the sampler. Hold Shift and press to eject the current track from the sampler (when the sampler is not playing.)
- **Volume knob** - Adjusts the volume of the sampler
- **Play** Press to play the sample from the beginning. Press while playing for a stutter-play effect (play again from the beginning.) Hold Shift and press to stop playing.
- **Rec** - *Currently does nothing*

## Mixer controls

The volume sliders don't control the ones in Mixxx because direct Deck outputs are affected by Mixxx's internal ones.

- **Midilog 1:** This strip controls Deck 3/C
- **Midilog 2:** This strip controls Deck 1/A
- **Midilog 3:** This strip controls Deck 2/B
- **Midilog 4:** This strip controls Deck 4/D

### 17.1.7 Behringer BCD2000

The Behringer B-Control DeeJay BCD2000 features a USB 4-channel audio interface plus 24-bit A/D and D/A converters.

This controller has been discontinued. The *Behringer BCD3000* is its successor.

- [Manufacturer's product page](#)
- [Forum thread](#)

Nuovo nella versione 1.11.

---

**Nota:** Unfortunately a detailed description of this controller mapping is still missing. If you own this controller, please consider [contributing one](#).

---

### 17.1.8 Behringer BCD3000

- [Manufacturer's page](#)

The B-Control DeeJay BCD3000 controller is a 4-channel audio interface. It offers a fully fitted controller console with 24-bit A/D and D/A converters, a USB audio interface with a microphone preamplifier, a 3-band kill EQ for each channel, faders, a crossfader and talkover function.

By default, the input channels 1-2 use the RCA phono inputs for the source signal. On Windows, this can be switched to the microphone in the ASIO driver control panel. On GNU/Linux and Mac OS X, [a particular MIDI message must be sent](#) to switch channels 1-2 to the microphone input.

Nuovo nella versione 1.6.

---

**Nota:** Unfortunately a detailed description of this controller mapping is still missing. If you own this controller, please consider [contributing one](#).

---

### 17.1.9 Behringer BCR2000

- [Manufacturer's product page](#)
- [Forum thread](#)

The B-CONTROL BCR2000 is a general-purpose *USB MIDI* controller containing 20 buttons, 24 rotary encoders and 8 push encoders. Every control is backed by LEDs that show the current value. As a pure MIDI controller it contains no interfaces for audio or microphones.

The controller can be configured extensively. It offers 32 presets that may be programmed by the user.

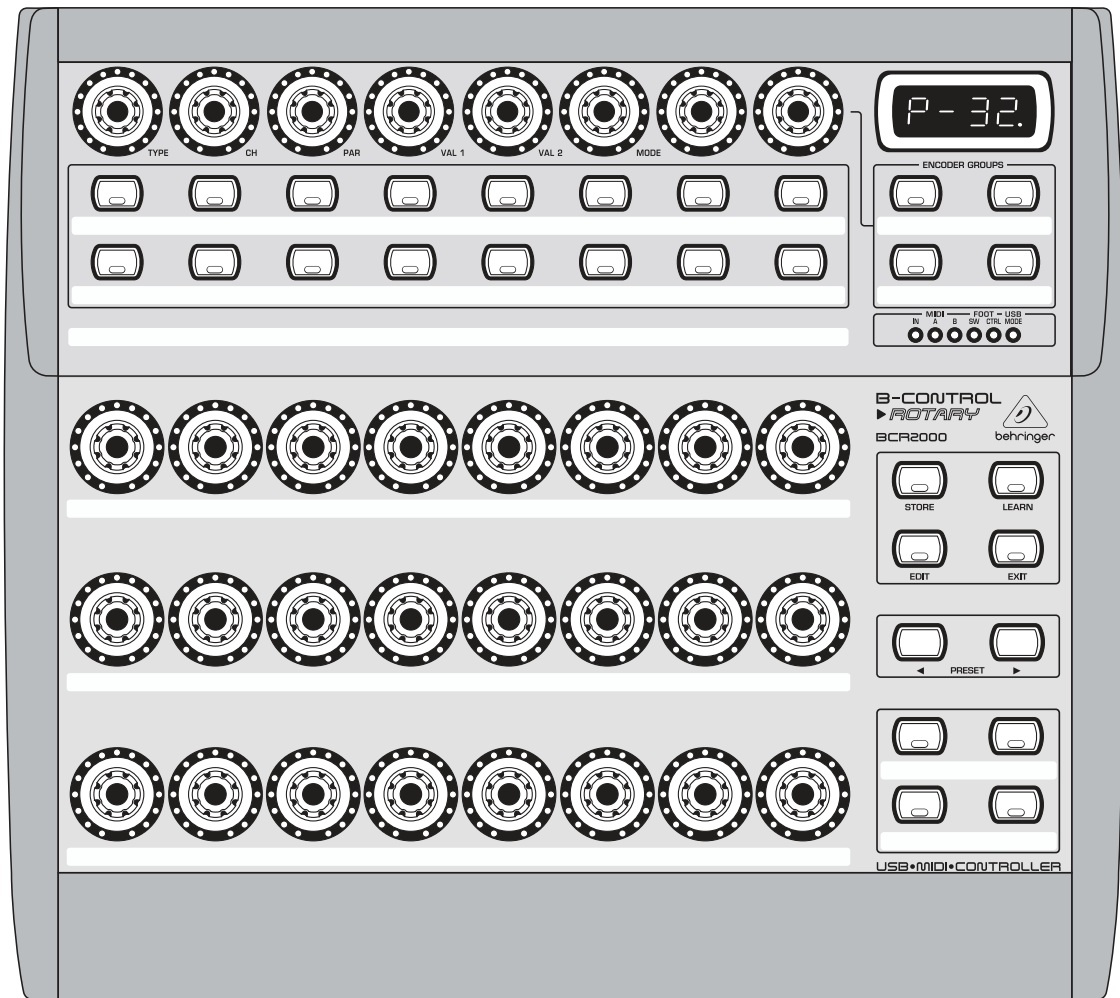

Figure1: Behringer BCR2000 (schematic view)



Nuovo nella versione 2.3.

## Compatibility

This controller is a class compliant USB MIDI and audio device, so it can be used without any special drivers on GNU/Linux, Mac OS X, and Windows.

## Setup

### Controller Preset

The default mapping works out-of-the-box for the factory settings of controller preset 1.

If you don't want to use this preset, you can choose one of the following options:

1. Load the dump file `bcr_Only_Controllers.syx` via Sysex to any other preset slot and update the preset number in the `init` function in the file `Behringer-BCR2000-scripts.js`. The dump file and instructions how to install it in the controller is available on the manufacturer's webpage.
2. Factory reset the controller.

### Button Behaviour

It is recommended, but not required, to change the button behaviour from *Toggle On* (default) to *Toggle Off*. Both behaviours send an `On` message on button press, but the action to send an `Off` message is different: *Toggle Off* responds to a button release while *Toggle On* ignores the release and requires a second press. To change the behaviour:

1. Hold EDIT, press a button, then release both
2. Turn the MODE encoder until the display shows `tOFF`
3. Press the EXIT button

To make the change persistent, press *Store* twice. See the controller manual for details.

### Mapping Description

The BCR2000 is a general purpose controller that allows different mappings.

The file `Behringer-BCR2000-scripts.js` contains a default mapping which works out-of-the-box for a factory-reset controller, but may be customized freely according to your needs.

The controls are divided into five parts:

- Top left area (4 push encoders + 4 buttons): loop, reverse & pitch controls for Deck 1
- Top right area (4 push encoders + 4 buttons): loop, reverse & pitch controls for Deck 2
- Middle left area (4 buttons + 4 encoders): controls for Effect Unit 1
- Middle right area (4 buttons + 4 encoders): controls for Effect Unit 2
- Bottom right area (4 buttons): controls for assignment of effect units to decks

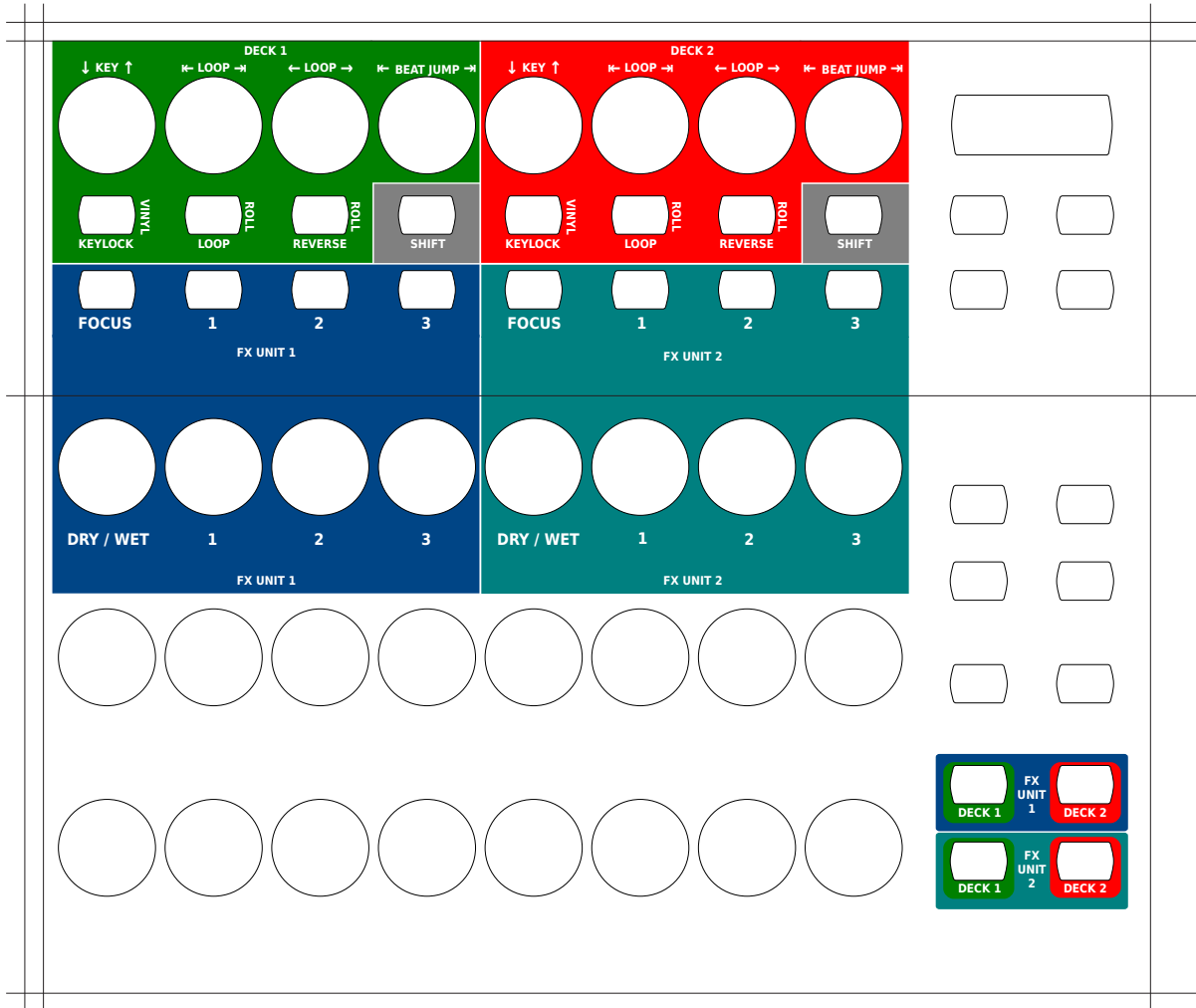

| Control          |         |                   | Description  |
|------------------|---------|-------------------|--|
| Location         | Affects | Hardware control  |  |
| Push Encoder Row | Deck 1  | Encoder 1 (TYPE)  | <ul style="list-style-type: none"> <li>• Rotate: Manipulates the key of the track in semitones.</li> <li>• Push: Resets the key to the original track key.</li> </ul>  |
|                  | Deck 2  | Encoder 5 (VAL 2) |  |
|                  | Deck 1  | Encoder 2 (CH)    | <ul style="list-style-type: none"> <li>• Rotate: Increases or decreases the size of the current loop in beats.</li> </ul>  |
|                  | Deck 2  | Encoder 6 (VAL 2) |  |
|                  | Deck 1  | Encoder 3 (PAR)   | <ul style="list-style-type: none"> <li>• Rotate: Moves the current loop left or right.</li> </ul>  |
|                  | Deck 2  | Encoder 7         |  |
|                  | Deck 1  | Encoder 4 (VAL 1) | <ul style="list-style-type: none"> <li>• Rotate: Increases or decreases the number of beats to move the loop.</li> </ul>   |
|                  | Deck 2  | Encoder 8         |  |
| Button Row 1     | Deck 1  | Button 1          | <ul style="list-style-type: none"> <li>• Press: Toggles key-lock.</li> <li>• Shift + Press: Toggles vinyl control mode.</li> </ul>   |
|                  | Deck 2  | Button 5          |  |
|                  | Deck 1  | Button 2          | <ul style="list-style-type: none"> <li>• Press: Toggles a loop that ends at the current play position.</li> <li>• Shift + Press: Toggles a rolling loop. Playback will resume where the track would have been if it had not entered the loop.</li> </ul> |
|                  | Deck 2  | Button 6          |  |
|                  | Deck 1  | Button 3          | <ul style="list-style-type: none"> <li>• Press: Toggles reverse playback.</li> <li>• Shift + Press: Toggles rolling reverse playback. Playback continues where the track would have been if it had not been temporarily reversed.</li> </ul>             |
|                  | Deck 2  | Button 7          |  |

continues on next page

Table 1 – continua dalla pagina precedente

| Control          |               |                  | Description  |
|------------------|---------------|------------------|--|
| Location         | Affects       | Hardware control |  |
|                  | All controls  | Button 4         | <ul style="list-style-type: none"> <li>Press: Toggles shift. Shift changes the behaviour of controls as described in this table, and additionally the behaviour of the effect units. See <a href="#">Standard Effects Mapping</a> for details.</li> </ul> <hr/> <p><b>Nota:</b> Both Shift buttons have the same effect, they are not deck-specific. This design decision was made to keep the layout symmetric so that you don't have to press a button on the left side when you're working on the right side.</p> <hr/> |
|                  | All controls  | Button 8         |  |
| Button Row 2     | Effect Unit 1 | Button 1         | <ul style="list-style-type: none"> <li>Press: Toggles effect focus mode.</li> <li>Shift + Press: Toggles effect unit.</li> <li>Press: Toggles parameter button 1.</li> <li>Press: Toggles parameter button 2.</li> <li>Press: Toggles parameter button 3.</li> </ul>   |
|                  | Effect Unit 2 | Button 5         |  |
|                  | Effect Unit 1 | Button 2         |  |
|                  | Effect Unit 2 | Button 6         |  |
|                  | Effect Unit 1 | Button 3         |  |
|                  | Effect Unit 2 | Button 7         |  |
|                  | Effect Unit 1 | Button 4         |  |
| Encoder Row 1    | Effect Unit 1 | Encoder 1        | <ul style="list-style-type: none"> <li>Rotate: Adjusts the mixing of the dry (input) signal with the wet (output) signal of the effect unit.</li> <li>Rotate: Controls the parameter of effect 1.</li> <li>Rotate: Controls the parameter of effect 2.</li> <li>Rotate: Controls the parameter of effect 3.</li> </ul>   |
|                  | Effect Unit 2 | Encoder 5        |  |
|                  | Effect Unit 1 | Encoder 2        |  |
|                  | Effect Unit 2 | Encoder 6        |  |
|                  | Effect Unit 1 | Encoder 3        |  |
|                  | Effect Unit 2 | Encoder 7        |  |
|                  | Effect Unit 1 | Encoder 4        |  |
| Button Box Row 1 | Deck 1        | Left Button      | <ul style="list-style-type: none"> <li>Press: Toggles assignment of Effect Unit 1.</li> </ul>  |
|                  | Deck 2        | Right Button     |  |
| Button Box Row 2 | Deck 1        | Left Button      | <ul style="list-style-type: none"> <li>Press: Toggles assignment of Effect</li> </ul>  |

continues on next page

Table 1 – continua dalla pagina precedente

| Control  |         |                  | Description |
|----------|---------|------------------|-------------|
| Location | Affects | Hardware control |             |
|          | Deck 2  | Right Button     |             |

## Overlay

Overlay to print on cardboard or paper for lamination:

- PDF, DIN A4
- PDF, DIN A3
- ODG (LibreOffice)
- SVG (without labels)

### 17.1.10 Behringer CMD Micro

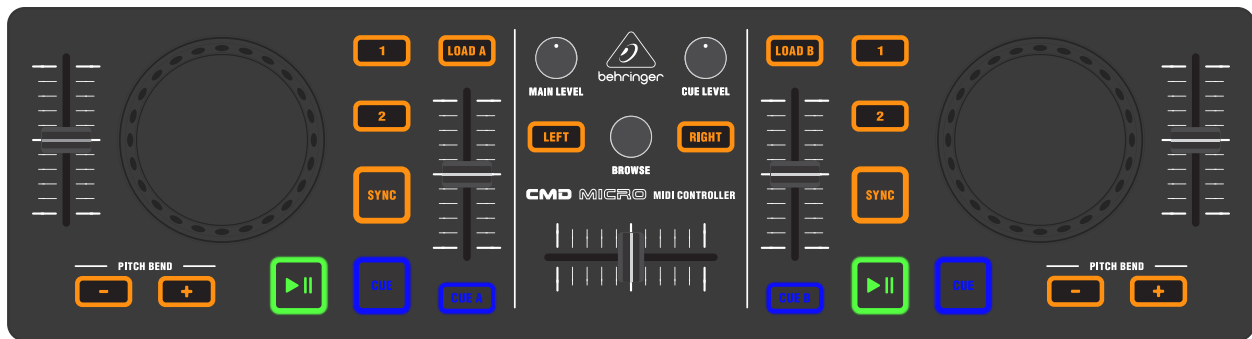

Figure2: Behringer CMD Micro (schematic view)

The *Behringer CMD Micro* is a simple controller for basic two-channel mixing. This device does not have a built in sound card, so it would require a *splitter cable* or *separate audio interface* to be able to preview tracks in headphones.

- [Manufacturer's product page](#)

Nuovo nella versione 2.1.

## Mapping description

- **Cue**, **Play/Pause**, **Sync**, **Load A**, **Load B**, the **Level / Browse** knobs, and the **crossfader** all behave as labeled.
- **Cue A** and **Cue B** send the respective track to the headphones.
- The inner vertical sliders control the track's volume.
- The outer sliders control the playback speed.
- The **1**, and **2** buttons toggle a 4 and 8 beat loop, respectively.
- The **Pitch Bend** buttons temporarily adjust the playback rate. They can be configured to change the key of the track instead by setting the `PitchBendsKey` option to true at the top of the JS file (open the JS file in a text editor such as Notepad, TextEdit, or gEdit to change this). With the `PitchBendsKey` option, when both buttons are pressed simultaneously, the key is reset to the track's default key.

## Jog Wheels

The jog wheels are touch enabled. When the top is pressed, they emulate turntable scratching. When the side is touched, they affect the playback speed (jog).

### 17.1.11 Behringer CMD MM-1

The Behringer CMD MM-1 is a flexible controller that controls 4 decks by default. The mapping can be easily configured to control any combination of decks and effect units. The Behringer CMD DC-1 and Behringer CMD DV-1 are designed to be used together with the CMD MM-1, but the CMD MM-1 can be used alone or with other controllers (especially the *Novation Launchpad*).

- [Manufacturer's product page](#)
- [Forum thread](#)

Nuovo nella versione 2.1.

## Mapping description

### Architecture

The controller has four strips of channels, each of which can be configured to control a different Deck or even an EffectUnit. These options can be changed during runtime via the Buttons in the of the **ThirdLayer**. You can find more about how to use this at the end of this document.

## Mapping options

There are a few user configurable options available for you to customize. You can change these by opening the `Behringer-CMD-MM-1-scripts.js` file with your text editor of choice (such as Notepad, TextEdit, Kate, or gEdit) and editing the lines at the very top of the file.

- `channelNumber`: change this if your *controller LEDs do not light up*.
- `invertColor`: Swaps the colors which suits certain skins more
- `defaultChannelSequence`: Defines how the channels are mapped when Mixxx starts
- `channelMode`: Defines if a channel is in Deck or FX Mode when Mixxx starts
- `faderMode`: Defines how the faders behave in FX Mode by default
- `standardKnobBehavior`: Defines the mapping of the knobs when Mixxx starts
- `navEncoderScale`: the factor of speedup when using the encoder with a modifier

## Top row



Figure3: Behringer CMD MM-1 (top row)

The top left knobs control the Master balance and Master gain. The top right knobs control the headphone gain and cue mix (PFL/master mix in Headphones output).

You can see the L/R buttons besides the encoder as `[SHIFT]` and `[CTRL]` buttons. These allow each button to have up to four functionalities. They behave like the Shift and Control keys on a computer keyboard.

## Knobs

The Knobs have three different modes which can be cycled while in operation. The knobs in each mode, from top to bottom, control:

1. Deck: High, Mid, Low, QuickEffect (filter by default)
2. Deck: Gain, High, Mid, Low
3. Effect Unit: Meta 1, Meta 2, Meta 3, Mix

The Effect Unit number is the same as the channel/deck number, so the channel that controls the knobs/buttons/faders of deck 1 also controls the knobs of EffectUnit1, Channel 2 controls EffectUnit2, and so on.

## FX Mode

The Knobs in FxMode overwrite the assigned mapping and are mapped as `[Effect 1 Meta, Effect 2 Meta, Effect 3 Meta, Super]` and the fader is also mapped to the mix of the EffectUnit. The buttons are documented in their own section.

## Middle button

- Normal: recenter Crossfader
- Shift: Cycle Knob assignment (swaps the mapping of the knobs as mentioned earlier)

## Buttons

### Deck Mode

[1]&[2] Buttons:

- Normal: Change Crossfader side (Orientation)
- Shift: Toggle Fx1&2 for desired Channel
- Ctrl: Toggle Fx3&4 for desired Channel
- Third: Change ChannelNumber/Assignment

[CUE] Buttons:

- Normal: Pre-Fader-Listening
- Shift: Load selected Track to Deck
- Ctrl: enable Sync for the Deck.
- Third: Change Channelmode

### FX Mode



Figure4: Behringer CMD MM-1 (FX mode)

[1]&[2] Buttons:

- Normal: Toggle Effect 1&2 in desired FxUnit
- Shift: Toggle Channel1&2 for desired FxUnit
- Ctrl: Toggle Channel3&4 for desired FxUnit
- Third: Change ChannelNumber/Assignment

[CUE] Buttons:

- Normal: Toggle Effect 3 for desired FxUnit
- Shift: Pre-Fader-Listening for FxUnit
- Ctrl: change mix\_mode of Unit
- Third: Change Channelmode



## Faders

DeckMode:

- Normal: Volume Fader

FxMode:

- EffectUnit Mix (dry/wet)
- Third: Reconfigure Fader to control Rate/BPM/Pitch of the Channel as if it was in Deckmode

## Reassigning channel mode and number

The channel modes and numbers can be set by changing the *#mapping options* at the top of the script. They can also be changed while using the controller when in **thirdMode**. Pressing the cue- button toggles between Deck and FX Mode. The Channel number is assigned with the [1]&[2] buttons.

They are mapped in a sort of two bit encoded system:

- & [ ] = Channel 1
- & [ ] = Channel 2
- & [x] = Channel 3
- & [x] = Channel 4

So you can change between channel 1&3 by pressing the [1] button, and channel 2&4 by pressing the [2] button.

You can change the Channel mode (Deck/Fx) via the Cue Button. (Note: there is a rare issue where you have to change the Channel mode after the assignment for it to work. So it is suggested that you always change the assignment first).

## Troubleshooting

### Controller does not light up

The issue is probably the MIDI channel of your MM-1. Behringer had a tool that can set the controller to a different MIDI channel, however this is no longer available for download from Behringer's website. So you will have to modify the controller mapping to use the MIDI channel that your controller is set to.

Once you know the MIDI channel of your controller, open the file `Behringer-CMD-MM-1-scripts.js` file with your text editor of choice (such as Notepad, TextEdit, Kate, or gEdit) and replace the number 5 in the line where it says `var CHANNELNUMBER = 5;`. Then, open the file `Behringer CMD-MM-1.midi.xml` in the same folder and replace the 4 at the end of 0x94, 0x84 and 0xB4 with your channel number - 1. Restart Mixxx, reload the mapping in Mixxx's preferences, and then it should work.

### 17.1.12 Behringer CMD STUDIO 4a

The Behringer CMD STUDIO 4a is a 2 deck controller that supports 4 virtual decks and has a built in 4 channel (one stereo master, one stereo headphones) USB sound card built in.

- [Manufacturer’s product page](#)
- [Mixxx Forum Thread](#)

Nuovo nella versione 2.1.

#### Mixxx Sound Hardware Preferences

- Master output: channels 1-2
- Headphone output: channels 3-4

#### Mapping description

Most of the buttons and knobs on the controller behave as they are labelled:

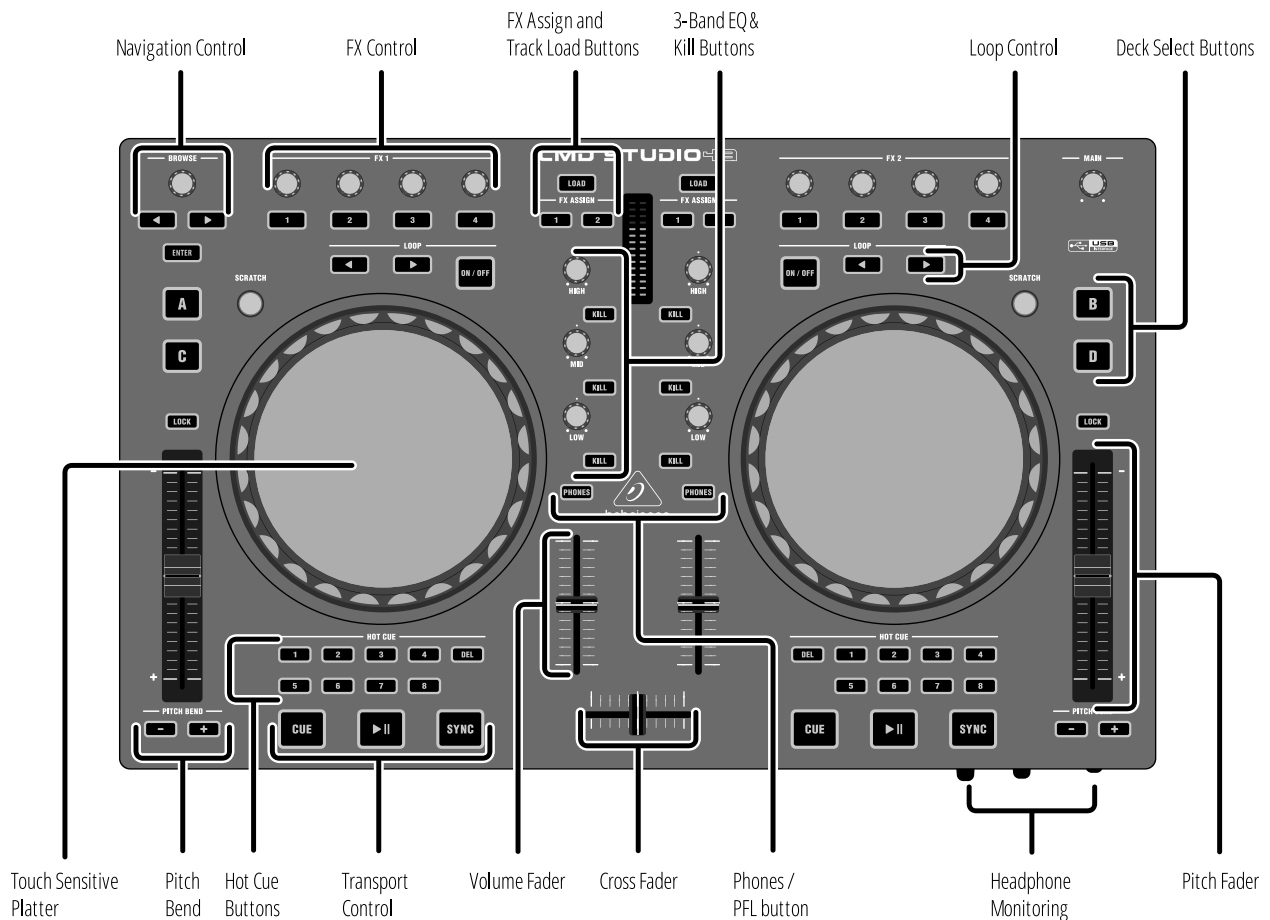

Figure5: Behringer CMD STUDIO 4a (top view)

The only major departure from the above are the 4 “FX Control” knobs and buttons at the top of each deck.

## Mixer

- The HIGH, MID, and LOW EQ knobs & kill buttons, deck faders, cross-fader, master, and headphone monitoring (mix & volume) knobs all operate as labelled.
- Each deck also has a gain knob (leftmost “FX Control” knob).

## Navigation Control

- The BROWSE knob scrolls through the track list in the library panel.
- The BROWSE LEFT/RIGHT buttons move through the library tree (and can also select effects, see later).
- The ENTER button expands/collapses library tree items.

## Deck Select Buttons

- The deck select buttons (A, B, C, D) make the respective “virtual” deck active.
- On the left deck: A = Channel 1, C = Channel 3.
- On the right deck: B = Channel 2, D = Channel 4.

## Transport Control

- The deck LOAD buttons will load the currently highlighted track in the library window into that deck.
- The deck CUE, PLAY, SYNC, and LOOP buttons work as labelled (SYNC toggles master sync for the deck).

## Wheels

- While a track is playing, spinning the wheels temporarily speeds up or slows down the track.
- When a track is stopped, spinning the wheels results in a fast search.
- When the top wheel surface is touched the wheels act as a precision jog.
- When the SCRATCH button is activated, moving the wheel while touching the top surface scratches the track.

## Hot Cue Buttons

- If not currently set, pressing a HOT CUE button sets that hot cue at the current playback position.
- If already set, pressing a HOT CUE button jumps to that hot cue position.
- If the DEL button is \*held\*, pressing an already set HOT CUE button will clear that hot cue.
- Tapping the DEL button toggles *#DEL-mode*. The button will light up blue. DEL-mode alters some of the other button functions like a shift button on other controllers.

## Playback Pitch/Rate

- The pitch sliders control the pitch.
- The PITCH BEND +/- buttons step the playback rate up or down (pressing both resets the rate back to normal).
- The LOCK buttons turn on key lock so the pitch doesn't change when the playback rate changes.
- The PITCH BEND button lights will indicate whether the current pitch is higher or lower than normal.

## FX Control Buttons

These do not control effects; they have other functions:

- FX Control button 1 toggles the deck slip-mode on/off, (button lights blue when active). Slip-mode is not available in any Mixxx skin yet so may be unfamiliar. When slip-mode is active, playback continues (muted in the background) during a loop/scratch etc. Once disabled, playback will resume where the track would have been if the loop/scratch has not taken place (thus preserving the track beat).
- FX Control button 2 toggles the deck repeat mode, (button lights blue when active).
- FX Control button 3 can be tapped to adjust the beat-grid position.
- FX Control button 4 toggles the deck quantise mode on/off, (button lights blue when active).

## FX Control knobs

- FX Control knob 1 = Deck gain.
- FX Control knob 2 = FX 1 "super" control (FX unit 1 on left deck, unit 3 on right deck).
- FX Control knob 3 = FX 2 "super" control (FX unit 2 on left deck, unit 4 on right deck).
- FX Control knob 4 = Deck "quick effect" control (by default this is a filter effect but can be changed in Mixxx's preferences).

## FX Assign Buttons

- Tapping either of the 2 FX ASSIGN buttons on each deck will toggle the deck's output to one (or both) of two effects in the (default) 4-unit effects rack. The left deck (A or C) can be assigned to effect units 1 and/or 2. The right deck (B or D) can be assigned to effect units 3 and/or 4.
- \*Holding\* an FX ASSIGN button allows the effect in that effect unit to be changed using the BROWSE LEFT/RIGHT buttons.

## DEL-mode

DEL-mode is activated by *tapping* the deck's hot cue DEL button (the button will light up blue). This is equivalent to a shift button on other controllers and so changes the behaviour of a number of the controller buttons as follows:

- The HOT CUE buttons act as auto-loop triggers (when \*held\*) in DEL-mode. The button layout follows the default "LateNight" skin (i.e. top row = [1/8] to [1], bottom row = [2] to [16] beats). Longer auto-loops can be "locked" (so the HOT CUE button doesn't have to be held) by pressing the LOOP ON/OFF button after an auto-loop is selected, (locked/playing auto-loops can also be resized by selecting a different auto-loop and then re-locking the new size with the LOOP ON/OFF button).

- The CUE button triggers reverse playback (while \*held\*).
- The PLAY button triggers reverse-slip playback (while \*held\*). NB: if you already have slip-mode activated before you trigger reverse-slip playback, (e.g. by having pressed FX-Control button 1), then slip-mode will be turned off as soon as you release the PLAY button (and you will return to the playback point where you would have been if you hadn't altered the playback).
- The PITCH BEND +/- buttons step the key up/down without altering the playback rate. If both PITCH BEND buttons are pressed together, the playback key is reset to normal.

### Auto-Loops and Slip-Mode

There are no “slip-mode aware” skins in Mixxx yet so the auto-loop behaviour of this controller (which \*is\* “slip-mode aware”) may be a little different than you might expect to take advantage of this feature.

- Auto-loop buttons are (by default) only active when held.
- In slip-mode, releasing an auto-loop button will immediately “re-sync” playback (by disabling, then immediately re-enabling slip mode), you may see the slip-mode button flash briefly when this happens. This allows for some very interesting “slip-auto-loop” effects.

### 17.1.13 Behringer DDM4000

The Digital Pro Mixer DDM4000 is a 5-Channel Digital DJ Mixer with Sampler, 4 FX Sections, BPM Counters and MIDI support. Each of the following sections can be configured separately to be used either for audio or as MIDI controller:

- Channel 1-4
- Microphone Channel
- Crossfader
- Sampler

The mixer contains no digital interfaces for audio or microphones.

- [Manufacturer's product page](#)
- [User Manual](#)
- [Forum thread](#)

Nuovo nella versione 2.3.

### Compatibility

This controller contains a *MIDI* interface with 5-pin DIN jacks In/Out/Thru. If your soundcard does not offer DIN jacks, a separate USB/MIDI interface is required to use it on GNU/Linux, Mac OS X, and Windows.

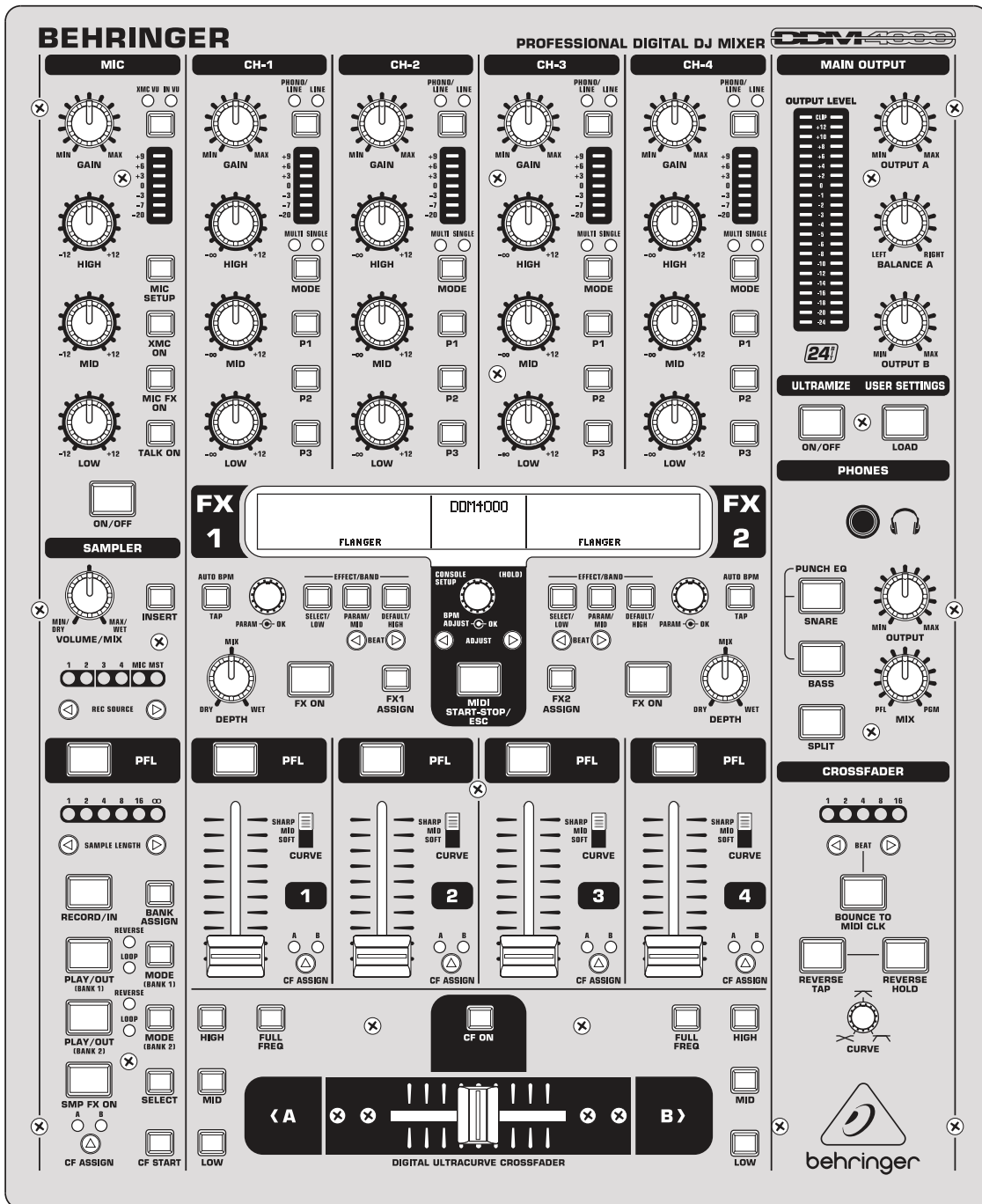

Figure6: Behringer DDM4000 (schematic view)

## Setup

Configure at least one mixer section as MIDI controller:

1. Long press the CONSOLE SETUP knob
2. Select MIDI SETTINGS by turning and pressing the CONSOLE SETUP knob
3. Select the sections that you want to use as MIDI controller
4. Press the ESC button to exit MIDI Setup
5. To make the change persistent, save the settings in a user preset. See the controller manual for details.

## Controller Mapping

A schematic drawing with the control numbers that are used here can be found on the specified page in the User Manual in the Links section.

### Stereo channels 1 – 4 (p. 6)

| No. | Control                | Function   |
|-----|------------------------|--|
| 4   | HIGH / MID / LOW knobs | Adjust high/mid/low-frequencies.                       |
| 6   | P1 / P2 / P3 buttons   | Toggle the kill function for high/mid/low-frequencies. |
| 7   | PFL button             | Toggle headphone pre-fader listening.                  |
| 8   | Channel faders         | Adjust the output volume.                              |
| 10  | CF ASSIGN button       | Assign the channel to either side of the crossfader.   |

**Nota:** On some units of this mixer, the LEDs of the buttons P1 / P2 / P3 show an unexpected behavior in MIDI mode. When such a LED is turned on via MIDI, it flashes shortly but does not stay lit. The problem occurs only when at least 1 channel is in audio (non-MIDI) mode. It does not occur when all channels are in MIDI mode. Firmware version 1.02 (Dec 14 2007) is known to show this behavior, and there's no fix available according to a reply from the technical support:

«I see the issue, but sorry, the code is 15 years old and getting the 15 year old tools (plus license, plus old windows version) needed to compile it, together with finding the bug in a very complex code base (without access to the developer) makes fixing this nearly impossible.»

---[MUSIC Tribe Care] Behringer - Technical Support (08 Sep 2021)

### Microphone (p. 6)

| No. | Control | Function                      |
|-----|---------|-------------------------------|
| 19  | TALK ON | Switch the Talkover function. |

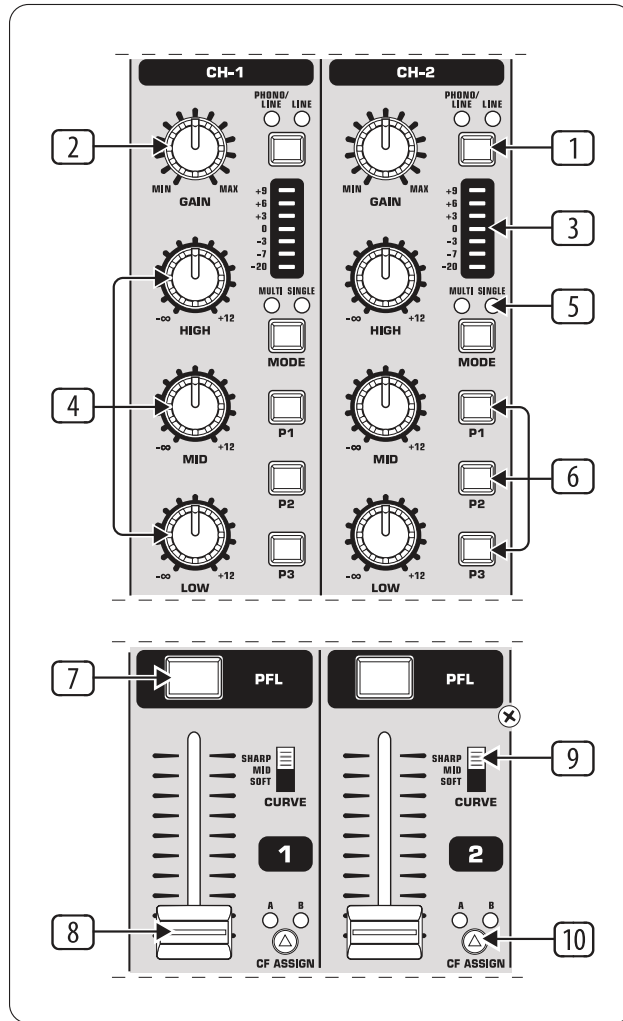

Figure7: Stereo channels strips



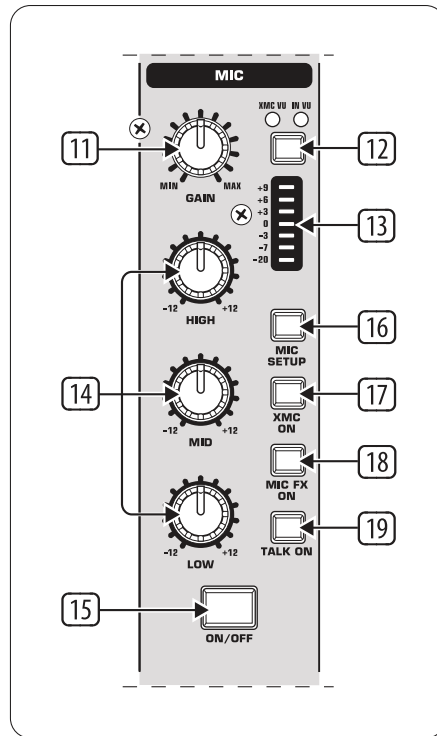

Figure8: Microphone channel

Crossfader section (p. 7)

| No. | Control             | Function  |
|-----|---------------------|---|
| 20  | Crossfader          | Fade between the signals that are assigned to its two sides A and B.  |
| 21  | CF ON button        | Toggle crossfader function. When disabled, the crossfader control in the Mixxx user interface is hidden.  |
| 24  | CURVE knob          | Adjust the response of the crossfader.  |
| 25  | REVERSE HOLD button | Toggle a permanent reverse of the crossfader sides A and B. This means that A and B are interchanged.   |
| 26  | REVERSE TAP button  | Toggle a momentary reverse of the crossfader sides A and B. This means that A and B are interchanged as long as the TAP push button is held down. |

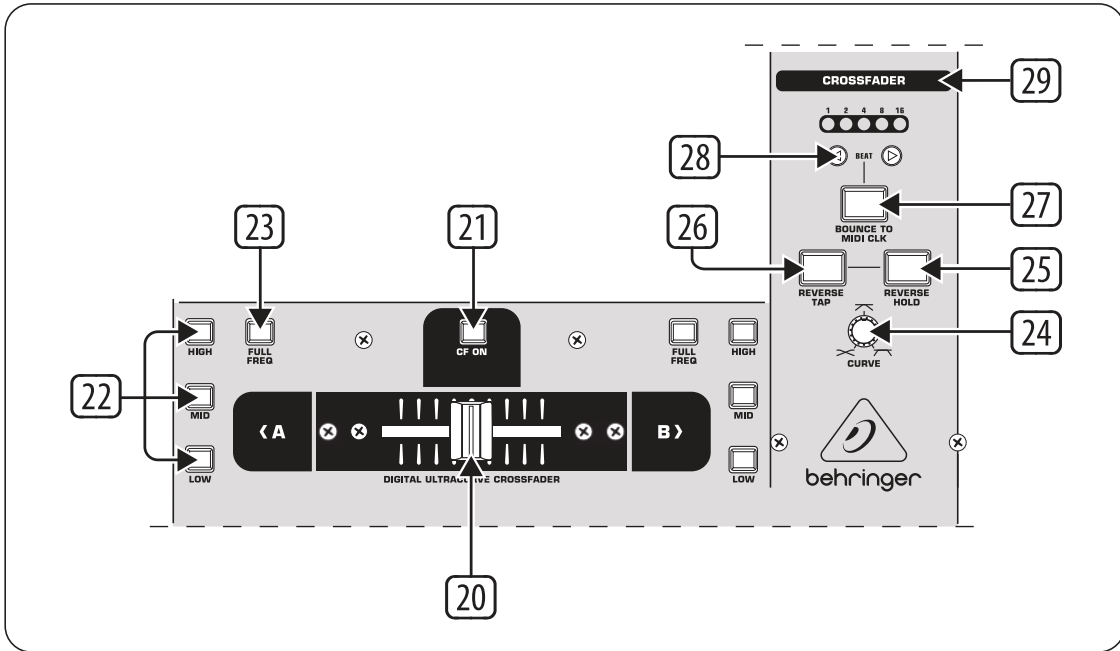

Figure9: Crossfader section

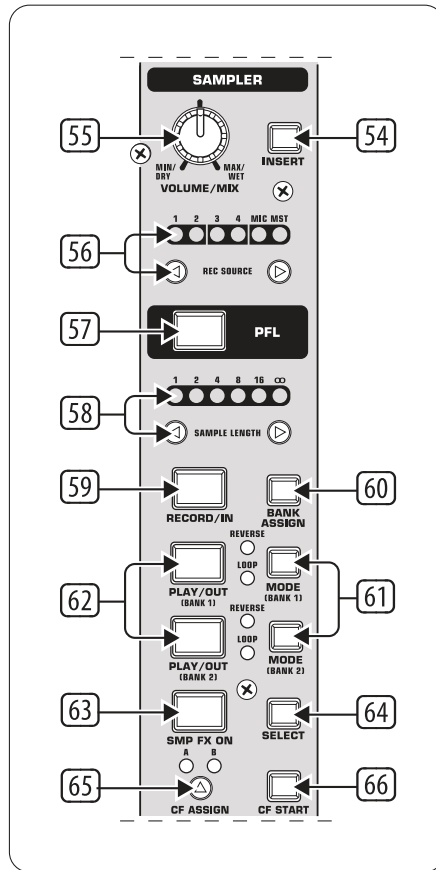

Figure10: Sampler section

## Sampler (p. 8)

| No. | Control                       | Function   |
|-----|-------------------------------|--|
| 55  | VOLUME/MIX knob               | Control the volume of sampler 1.   |
| 57  | PFL button                    | Toggle headphone pre-fader listening for sampler 1.  |
| 58  | SAMPLE LENGTH buttons         | Adjust the beatloop size of sampler 1.   |
| 61  | MODE buttons for bank 1/2     | Select the playback type for the selected sampler (Reverse or Loop). A short press toggles the Reverse function, a long press toggles the Loop function. |
| 62  | PLAY/OUT buttons for bank 1/2 | Start or stop playback for the selected sampler. When the Loop function is disabled, the sample is only played back while the button is pressed.         |
| 63  | SMP FX ON button              | Toggle effect unit 1 for sampler 1.  |
| 65  | CF ASSIGN button              | Assign sampler 1 to either side of the crossfader.   |

### 17.1.14 Denon DN-HS5500

- [Manufacturer's product page \(archived\)](#)

Nuovo nella versione 2.0.

---

**Nota:** Unfortunately a detailed description of this controller mapping is still missing. If you own this controller, please consider [contributing one](#).

---

### 17.1.15 Denon DN-SC2000

- [Forum thread](#)

Nuovo nella versione 1.8.

---

**Nota:** Unfortunately a detailed description of this controller mapping is still missing. If you own this controller, please consider [contributing one](#).

---

### 17.1.16 Denon MC3000

- [Manufacturer's product page \(archived\)](#)

Nuovo nella versione 2.0.

---

**Nota:** Unfortunately a detailed description of this controller mapping is still missing. If you own this controller, please consider [contributing one](#).

---

### 17.1.17 Denon MC4000

The MC4000 is a 2-deck DJ controller for the professional entertainer wrapping in-demand audio manipulation tools in a robust steel chassis for rugged durability. In addition to precision touch-activated jog wheels, performers get access to dedicated hot cue and sample pads for on-the-fly remixes.

- [Manufacturer’s product page](#)
- [Manual / Midi commands](#)
- [Forum thread](#)

The microphone and auxiliary inputs are mixed with the master output in hardware. They are not available to the computer through the MC4000’s sound card, so this controller’s sound card is not suitable for broadcasting or recording the inputs. You could use the controller with a separate USB sound card that has a microphone input for that purpose.

Nuovo nella versione 2.1.

#### Mapping Description

The Mixxx mapping is mostly the same as the standard Serato mapping, with a few exceptions which are highlighted below with *underlined text* where a specific functionality that exists in Serato is not (yet) implemented in the Mixxx mapping.

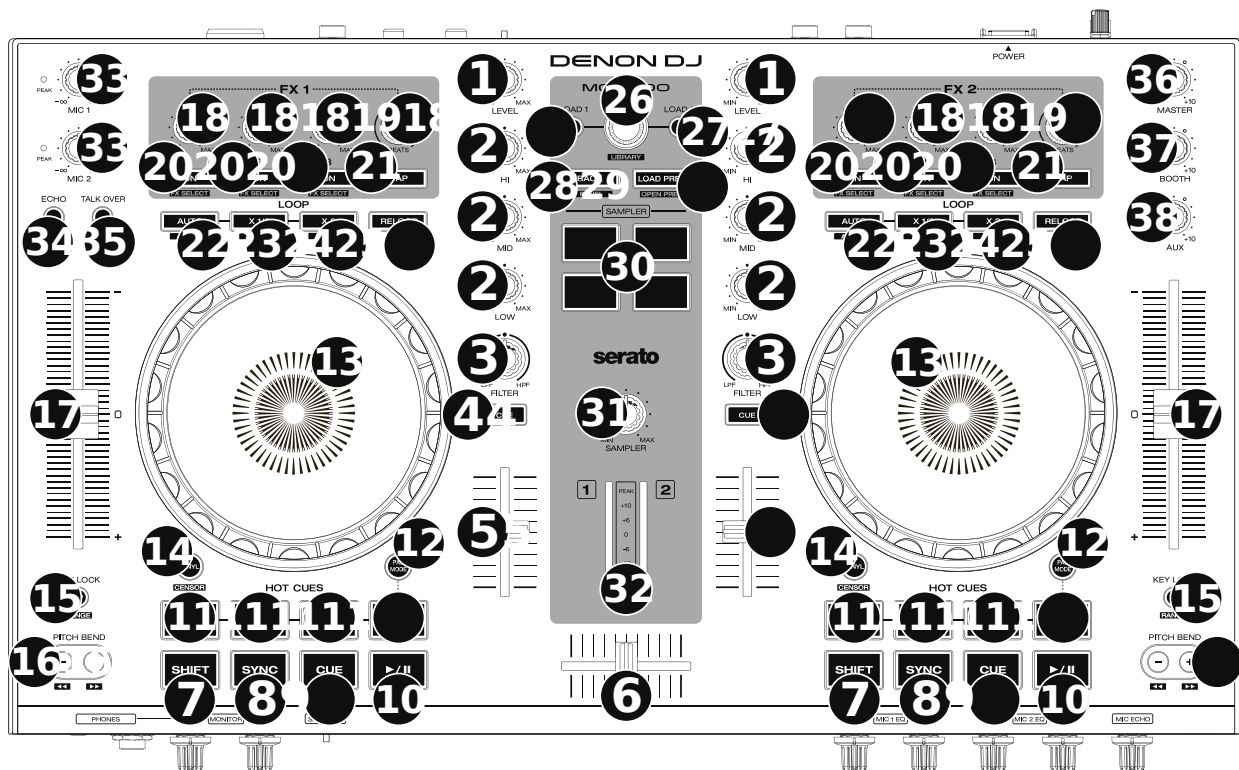

Figure 11: Denon MC4000 (layout)

1. **Channel Level:** Adjust the level of the pre-fader, pre-EQ audio signal
2. **Channel EQ:** Boost or cut the high, mid-range, and low frequencies
3. **Channel Filter:** Turn counterclockwise to apply a low-pass filter. Turn clockwise to apply a high-pass filter.
4. **Channel Cue:** Send the channel’s pre-fader signal to the headphones’ cue channel.

5. **Channel Fader:** Adjust the channel's volume level.
6. **Crossfader:** Mix between the two decks.
7. **Shift:** Press and hold this button to access secondary functions of other controls.
8. **Sync / Sync Off:** Automatically match the corresponding Deck's tempo with the opposite Deck's tempo and phase. *Unlike Serato, Shift + sync is not mapped to anything.*
9. **Cue / Track Start:** Behavior changes according to the *cue mode selected in Mixxx's preferences*. Hold Shift and press this button to return to the start of the track.
10. **Play/Pause / Stutter:** Play/pause playback. Hold Shift and press to "stutter-play" the track from the cue point.
11. **Hot Cues:** Press a pad to set or jump to a hot cue point. To set a hot cue point, press an unlit pad at the desired location in the track (the pad will then be lit). To jump to that hot cue point, press the lit pad. To delete a hot cue point, hold Shift and press a lit pad.
12. **Pad Mode:** *Currently unmapped*
13. **Platter:** This capacitive, touch-sensitive platter controls the audio playhead when the wheel is touched and moved. When the Vinyl button is on, move the platter to "scratch" the track like a vinyl record. When the Vinyl button is off (or if you are touching only the side of the platter), move the platter to temporarily adjust the track's speed.
14. **Vinyl / Censor:** Toggle "vinyl mode" for the platter. When activated, you can use the platter to scratch the track as you would with a vinyl record. Hold Shift and this button to activate the Censor feature: the playback of the track will be reversed, but when you release the button, normal playback will resume from where it would have been if you had never engaged the Censor feature (i.e., as if the track had been playing forward the whole time).
15. **Key Lock / Range:** Toggle Key Lock. When Key Lock is activated, the track's key will remain the same even if you adjust its speed. Hold Shift and press to cycle through the available ranges of the pitch fader (+/- 8%, 16%, 50%). Other ranges for the fader can be selected in Mixxx's Preferences in the Interface section, but pressing this button with Shift will only cycle through 8%, 16%, and 50%.
16. **Pitch Bend +/- :** Hold one of these buttons to momentarily reduce or increase (respectively) the speed of the track. Hold Shift and then press and hold one of these buttons to rewind or fast-forward (respectively) through the track.
17. **Pitch Fader:** Move this fader to adjust the speed (pitch) of the track. You can adjust its total range with the Key Lock / Range button.
18. **FX Level:** Turn the knobs on the left side of the controller to adjust the effect intensity (i.e. "meta" parameter) for the effects in Effect Unit 1. Turn the knobs on the right side of the controller to adjust the meta parameter for the effect in Effect Unit 2. The FX On button under the knob must be lit for the effect to be enabled.
19. **FX Beats:** Currently changes the wet/dry ratio of the effect chain. This will probably change in the future.
20. **FX On / Select:** Press to toggle the corresponding effect on or off. Hold Shift and press to assign a different effect to this slot.
21. **FX Tap:** *Currently not mapped*
22. **Auto-Loop / Auto 4:** Toggle a 4 beat loop on or off. Hold Shift and press to toggle beat quantize on or off (I.e quantization of loop start / end points to the nearest beat). *Note: this behavior is different from Serato.*
23. **X 1/2 Loop / Loop In:** Halve the length of the current loop. Hold Shift and press to create a Loop In point at the current location.
24. **X 2 Loop / Loop Out:** Double the length of the current loop. Hold Shift and press to create a Loop Out point at the current location.
25. **Reloop:** Exit the current loop if a loop is active, or skip to the last-played loop and activate it immediately if there is no loop active.

26. **Browse / Library Knob:** Turn to browse through the items in the currently focused pane (i.e. library or sidebar). Press shift and turn to scroll *quickly* through the items in the currently focused pane. Press the knob to select the current item.
27. **Load:** Load the currently selected track to the deck.
28. **Back / Panel:** Change the currently focused pane (i.e. library or sidebar) to the next or previous pane.
29. **Load Prep / Open Prep:** Load the currently selected track to the preview deck. Hold Shift and press to eject the current track from the preview deck. (*Different from Serato mapping*).
30. **Sampler Pads:** Press to play the corresponding samples in the software’s sampler (1–4). Hold Shift and press a pad to stop its sample playback.
31. **Sample Level:** Turn this knob to adjust the volume level of the software’s samplers (1–4).
32. **Level Meters:** These LEDs display the level of the audio signal depending on the state of each deck and Channel Fader. The meters are not affected by the position of the Master Knob.
33. **Mic Volume:** Adjust the input gain of the microphone. This adjusts the hardware microphone preamplifier, not Mixxx’s mic gain. The microphone input is not available to the computer through the MC4000’s sound card; it is mixed with the master output in hardware.
34. **Mic Echo:** Toggle an echo effect on the microphone input. This effect is done in hardware, not in Mixxx.
35. **Mic Talk Over / Post:** Toggle microphone talkover, which automatically reduces the volume of the music when using the microphone. Hold shift and press to toggle whether the microphone input is routed to the booth output. These controls are done by the MC4000 in hardware and do not affect Mixxx.
36. **Master:** Adjust the master output level of the sound card. This does not affect the master gain in Mixxx.
37. **Booth:** Adjust the booth output level of the sound card. This does not affect anything in Mixxx.
38. **Aux:** Adjust the auxiliary output level of the sound card. This does not affect anything in Mixxx.

### 17.1.18 Denon MC6000MK2

- [Manufacturer’s product page](#) (archived)
- [Forum thread](#)
- [Mixxx maintainer](#)

Nuovo nella versione 2.0.

The number in the first column refers to the corresponding label in the *Owner’s Manual* in the chapter *Part names and functions* starting on page 20.

| # User Manual | Control         | Modifier | Context         | Function                         |
|---------------|-----------------|----------|-----------------|----------------------------------|
| 1             | BEATS/V.FX SEL. |          | Knob is turned  | Effect unit dry/wet mix          |
|               |                 |          | Knob is pressed | Focus/unfocus effect unit        |
| 2             | TAP             | NONE     |                 | Toggle (enable/disable) EFX unit |
| 3             | EFX 1/2/3 KNOB  |          |                 | Effect meta knob                 |
| 4             | EFX 1/2/3 ON    |          |                 | Enable/disable effect            |
| 5             | EFX CH. ASSIGN  | NONE     |                 | Assign/unassign deck             |
|               |                 | SHIFT    |                 | Assign deck exclusively          |
| 6             | LOOP IN         | NONE     |                 | Set loop in point                |
|               |                 | SHIFT    |                 | Delete loop                      |
| 6             | LOOP OUT        | NONE     |                 | Set loop out point               |

Table 2 – continua dalla pagina precedente

| # User Manual | Control          | Modifier | Context           | Function   |
|---------------|------------------|----------|-------------------|--|
|               |                  | SHIFT    |                   | Delete loop out point                                  |
| 7             | AUTO LOOP        | NONE     | Loop is undefined | Activate a loop over beatloop size beats               |
|               |                  | SHIFT    | Loop is undefined | Activate a rolling loop over beatloop size beats       |
|               |                  | NONE     | Loop is defined   | Toggle reloop  |
|               |                  | SHIFT    | Loop is defined   | Delete loop  |
| 7             | LOOP +           | NONE     |                   | Double beatloop size beats                             |
|               |                  | SHIFT    |                   | Move loop forward by beatloop size beats               |
| 7             | LOOP -           | NONE     |                   | Halve beatloop size beats                              |
|               |                  | SHIFT    |                   | Move loop backward by beatloop size beats              |
| 8             | HOT CUE 1/2/3/4  | NONE     | Deck is stopped   | Jump to hot cue and start playing while pressed        |
|               |                  | NONE     | Deck is playing   | Jump to hot cue  |
|               |                  | SHIFT    |                   | Delete hot cue   |
| 8             | SAMPLE 1/2/3/4   | NONE     | Sampler is empty  | Load selected track into sampler                       |
|               |                  | NONE     | Press button      | Play track from beginning while pressed                |
|               |                  | NONE     | Release button    | Stop playback  |
|               |                  | SHIFT    | Release button    | Continue playback                                      |
|               |                  | SHIFT    | Press button      | Eject track from sampler                               |
| 9             | DECK             |          |                   | Switch active deck                                     |
| 10            | SHIFT            |          |                   | Modifier that activates a 2nd layer of functions. It o |
| 11            | KEY LOCK         |          |                   | Enable/disable key lock mode                           |
| 12            | HOT CUE / SAMPLE |          |                   | Switch between hot cues and samplers                   |
| 13            | JOG WHEEL        | NONE     |                   | Bend or scratch (vinyl mode)                           |
|               |                  | SHIFT    | Deck is stopped   | Fast track seek (wheel search)                         |
| 14            | PITCH SLIDER     |          |                   | Change playback speed                                  |
| 15            | SYNC             |          |                   | Trigger sync mode by short/long press                  |
| 16            | CUE              | NONE     |                   | Trigger cue according to configured cue mode           |
|               |                  | SHIFT    |                   | Stop playback and jump to beginning of track           |
| 17            | PLAY             | NONE     |                   | Start/stop/continue playback                           |
|               |                  | SHIFT    |                   | Reverse playback direction                             |
| 18            | SLIP/CENSOR      | NONE     |                   | Censor: Enable reverse and slip mode while presse      |
|               |                  | SHIFT    |                   | Toggle (enable/disable) slip mode permanently          |
| 19            | PITCH BEND +     |          | Deck is stopped   | Fast forward   |
|               |                  | NONE     | Deck is playing   | Pitch bend up  |
|               |                  | SHIFT    | Deck is playing   | Pitch bend up (small)                                  |
| 19            | PITCH BEND -     |          | Deck is stopped   | Fast rewind  |
|               |                  | NONE     | Deck is playing   | Pitch bend down  |
|               |                  | SHIFT    | Deck is playing   | Pitch bend down (small)                                |
| 20            | VINYL            |          |                   | Enable/disable vinyl mode (scratching)                 |
| 23            | X-F LINK         |          |                   | <i>Not yet mapped</i>                                  |
| 21            | PANEL            |          |                   | <i>Not yet mapped</i>                                  |
| 22            | VIEW             |          |                   | <i>Not yet mapped</i>                                  |
| 24            | AREA             |          |                   | <i>Not yet mapped</i>                                  |
| 25            | LIST             |          |                   | Toggle maximized library view                          |
| 26            | BACK             | NONE     |                   | Scroll up  |
|               |                  | SHIFT    |                   | Move focus backward to previous panel                  |
| 26            | FWD              | NONE     |                   | Scroll down  |
|               |                  | SHIFT    |                   | Move focus forward to next panel                       |
| 27            | SELECT KNOB      | NONE     | Knob is turned    | Move through focused panel/list                        |
|               |                  | SHIFT    |                   | Scroll through focused panel/list                      |

Table 2 – continua dalla pagina precedente

| # User Manual | Control               | Modifier | Context         | Function  |
|---------------|-----------------------|----------|-----------------|---|
|               |                       | NONE     | Knob is pressed | Go to the selected item                                   |
|               |                       | SHIFT    |                 | Move focus backward to previous panel                     |
| 28            | LOAD                  | NONE     |                 | Load selected track into active deck                      |
|               |                       | SHIFT    |                 | Eject loaded track from active deck                       |
| 29            | FILTER ON             |          |                 | Enable/disable filter effect for deck 1/3 or 2/4          |
| 30            | FILTER KNOB           |          |                 | Control filter effect (low/high pass) for deck 1/3 or 2/4 |
| 31            | MIC LEVEL 1/2         |          |                 | <i>Not yet mapped</i>                                     |
| 32            | MIC ON 1/2            |          |                 | <i>Not yet mapped</i>                                     |
| 33            | MIC DUCKING           |          |                 | <i>Not yet mapped</i>                                     |
| 34            | MIC ECHO ON 1/2       |          |                 | <i>Not yet mapped</i>                                     |
| 35            | CUE MIX               | NONE     |                 | Enable/disable cue mix                                    |
|               |                       | SHIFT    |                 | Enable solo cue mix (only this channel)                   |
| 36            | VU METER DISP. SWITCH |          |                 | Select channel(s) for display                             |
| 37            | CHANNEL FADER         |          |                 | Control channel output volume                             |
| 38            | CROSS FADER           |          |                 | Control balance between assigned channels                 |
| 39            | VU METER              |          |                 | Display channel/master output volume                      |
| 40            | BOOTH ASSIGN          |          |                 | Select source for booth output                            |
| 41            | BOOTH LEVEL           |          |                 | Control booth output volume                               |
| 42            | MASTER LEVEL          |          |                 | Control master output volume                              |
| 43            | HI KNOB               |          |                 | Control channel EQ (high freq.)                           |
| 43            | MID KNOB              |          |                 | Control channel EQ (mid. freq.)                           |
| 43            | LOW KNOB              |          |                 | Control channel EQ (low freq.)                            |
| 44            | LEVEL KNOB            |          |                 | Control channel gain                                      |
| 45            | CHANNEL INPUT SELECT  |          |                 | Select channel input source                               |

### 17.1.19 Denon MC7000

The Denon MC7000 is a professional DJ controller which has got 4-channel capability and dual USB connections. These two USB audio interfaces enable two DJs to play together. This controller includes Denon’s high build quality and superior 24-bit audio reproduction, makes this suited to both mobile and club DJs.

Nuovo nella versione 2.2.4.

Cambiato nella versione 2.3.0: Fixed a vinyl mode bug on deck 4 and added new features, like library sorting, searching through track with jog wheel, ejecting track from deck, waveform zoom, fixed loops and an experimental beat counter (slicer-like) and improved parameter and censor/reverse/spinback button mappings.

Cambiato nella versione 2.3.1: Some improvements for slip mode, sampler play and rate range toggle. Added browsing through library using jog wheel.

#### Useful links

- [Denon MC7000 Mapping thread](#)
- [Manufacturer’s product page](#)
- [User Guide](#)
- [Hardware Setting Specification](#)
- [Mixxx showcase on YouTube](#)



## Compatibility

- **Mac** users should be just fine connecting the MC7000 and go.
- **Windows** users need to install the latest Windows Driver from [Denon Download Site](#).
- **Linux** users need a minimum LTS Kernel version **4.19.105** or **5.4.21**. All Kernels **5.6.x** and following are supporting the device out-of-the-box.

## Mapping

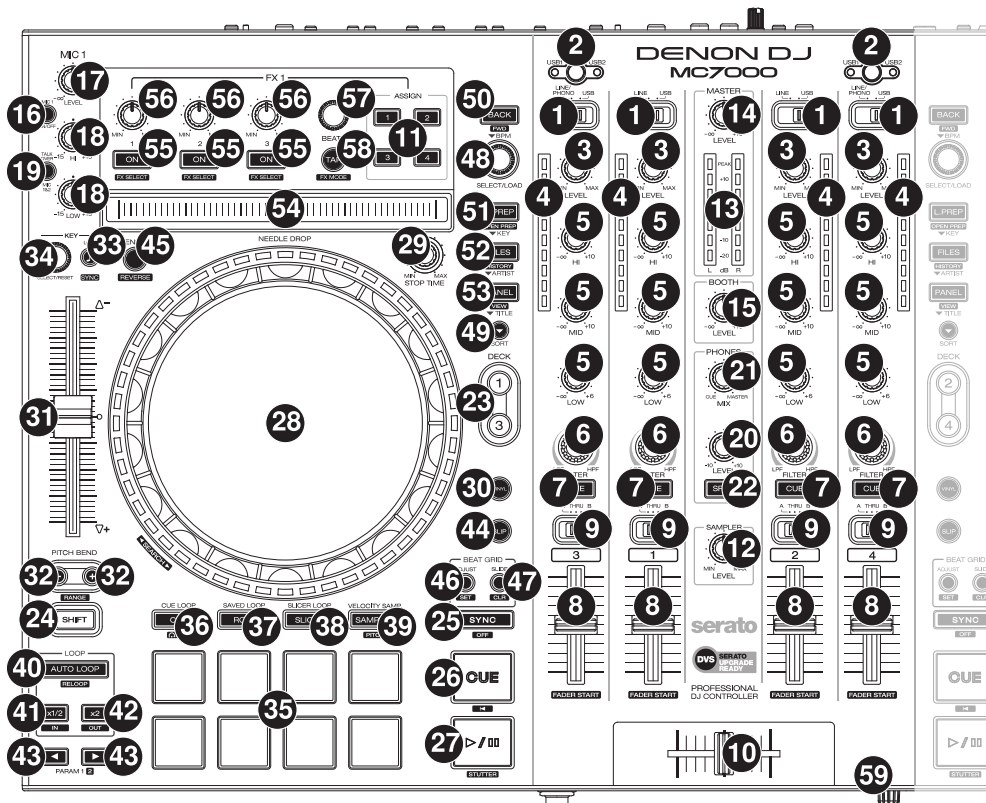

Figure12: Denon MC7000 (schematic view)

This controller is made for Serato DJ and most of the mapping is made for Mixxx accordingly. Anyhow, there are several differences for functions not matching the Serato mapping. If you have any wishes to improve the mapping, then please discuss it in the [Denon MC7000 Mapping](#) thread.

## User Variables

User variables can be set to suit individual needs inside the `Denon-MC7000-scripts.js` mapping file:

- `MC7000.experimental` activate *experimental beat count feature* (default: `false`)
- `MC7000.needleSearchPlay` activate NEEDLE DROP sensor while a track is playing (default: `false`)
- `MC7000.prevSamplerStop` set to single play samplers (default: `true`)
- `MC7000.rateRanges` set the available Pitch Fader ranges (default: 4, 6, 8, 10, 16, 24, 50, 90)
- `MC7000.modeSingleLED` set single LED on or off (default: 1). Can be toggled with SHIFT + Deck
- `MC7000.VinylModeOn` set the Vinyl Mode on or off at Mixxx start which also triggers the Platter Ring LED function (default: 1)
- `MC7000.scratchParams` set Scratch Parameters (default: 33+1/3, 1/10, 1/10/32)
- `MC7000.jogSensitivity` set the Jog Sensitivity (default: 1)

Mixer Section

| No | Control               | Function   |
|----|-----------------------|--|
| 1  | Input Selector Switch | Set to the desired audio source for this channel.<br>LINE/PHONO will disable the corresponding Deck (switches off all LEDs and the controller will not send MIDI signals to control Mixxx). This allows the mixer to use an external source.<br>USB will turn the corresponding Deck on and allows to control Mixxx via USB connection.                            |
| 2  | USB1 / USB2           | Press to select whether the deck is controlling the computer connected to USB Port 1 or USB Port 2. If only one USB Port is connected the controller activates this automatically.   |
| 3  | LEVEL                 | Turn to adjust the level of the pre-fader, pre-EQ audio signal for the channel.  |
| 4  | Channel Level Meters  | Display the audio signal level of the channel as in Mixxx GUI.   |
| 5  | Channel EQ            | Turn to boost or cut the HI, MID and LOW frequencies for the channel.  |
| 6  | FILTER                | Turn this knob to adjust the filter applied to the channel. Turn the knob counter-clockwise to apply a low-pass filter. Turn the knob clockwise to apply a high-pass Filter.   |
| 7  | CUE                   | Press to send the channel's pre-fader signal to the headphones' cue channel.   |
| 8  | Channel fader         | Use to adjust the channel's volume level.  |
| 9  | Crossfader Assign     | Routes the audio playing on the corresponding channel to either side of the crossfader (A or B), or bypasses the crossfader and sends the audio directly to the program mix (THRU).  |
| 10 | Crossfader            | Use this crossfader to mix between the left and right decks.   |
| 12 | SAMPLER LEVEL         | Turn this knob to adjust the volume level of the software's sampler. If the volume is set to 0 then the Sampler banks are hidden, otherwise shown.   |
| 13 | Master Level Meters   | These LEDs show the Master Audio signal.   |
| 14 | MASTER LEVEL          | Turn to adjust the volume level of the master outputs.   |
| 15 | BOOTH LEVEL           | Turn to adjust the volume level of the booth outputs.  |
| 20 | PHONES LEVEL          | Turn to adjust the volume level of the headphones.   |
| 21 | PHONES MIX            | Adjusts the software's audio output to the headphones, mixing between the cue output and the master mix output.  |
| 22 | SPLIT                 | Press to switch Headphone "split" mode. When this switch is lit, the headphone audio will be "split" such that all channels sent to cue channel are summed to mono and sent to the left headphone channel and the master mix is summed to mono and sent to the right channel. When the switch is unlit, the cue channel and master mix will be "blended" together. |
| 59 | X FADER CONTOUR       | Turn to adjust the slope of the crossfader curve, to the left for a smooth fade (mixing) or to the right for a sharp cut (scratching).   |

**Nota:** The Input source selection, Master Level Meters, USB1 / USB2, MASTER LEVEL, BOOTH LEVEL, PHONES LEVEL, PHONES MIX and SPLIT are handled by the controller. The status of Mixxx will not be changed.

## Microphone Section

| No. | Control                              | Function  |
|-----|--------------------------------------|---|
| 16  | MIC ON/OFF                           | Press to activate/deactivate the microphones.   |
| 17  | MIC LEVEL                            | Turn to adjust the volume levels of the corresponding microphone inputs.  |
| 18  | MIC 1 HI/MIC 1 LOW (left deck)       | Turn to boost or cut the high or low frequencies for Microphone 1.  |
| 18  | MIC 2 TONE (right deck)              | Turn to adjust the tone (high-low) for Microphone 2.  |
| 18  | ECHO MIC 1&2 (right deck)            | Turn to adjust the amount of the echo effect for both Microphones.  |
| 19  | TALKOVER MIC 1&2 (left deck)         | Press to use the “talkover” feature, which automatically reduces the volume level of the master mix when you speak into the microphones.  |
| 19  | SHIFT + TALKOVER MIC 1&2 (left deck) | Press to activate/deactivate the “Post” feature. When on, the microphones signal will be sent to the Booth Outputs. When off, the microphones signal will not be routed to the Booth Outputs. |
| 19  | ECHO MIC 1&2 (right deck)            | Press this button to activate or deactivate the echo effect on the microphones’ audio signal.   |

**Nota:** All functions are handled by the controller in hardware. The status of Mixxx will not be changed.

## FX Section

| No. | Control          | Function   |
|-----|------------------|--|
| 11  | FX ASSIGN        | Press assign FX 1 and/or FX 2 to the corresponding channel.  |
| 55  | FX ON            | Press to turn the corresponding effect on or off.  |
| 55  | SHIFT + FX ON    | Press to select an effect from the list that was enabled in the Mixxx Preferences FX section.                                |
| 56  | FX 1, FX 2, FX 3 | Turn to adjust the level of the corresponding effect. The FX ON button under the knob must be lit for this knob to function. |
| 57  | FX BEATS         | Turn to adjust the Wet/Dry rate of the effects.  |
| 58  | FX TAP           | Press to activate effects for the Master output. This can be overlapped with Channel Effects.                                |
| 58  | SHIFT + FX TAP   | Press to activate effects for headphones cue.  |

## Library Section

| NoControl              | Function   |
|------------------------|--|
| 48 SELECT/LOAD         | Turn to navigate through lists. Press the left side button to load a track into the active Deck (1 or 3), press the right side button to load a track into the active Deck (2 or 4).<br>When you keep the knob pressed down longer than 0,5 sec an actual loaded track will be ejected from the deck upon release of the knob. |
| 48 SHIFT + SELECT/LOAD | Turn to browse quickly through the tracks in the library or push the knob to open folders on the left side of the library.   |
| 49 SORT                | Press and hold to activate sort functions.   |
| 50 BACK                | Press to switch between right and left side of the library.  |
| 50 SHIFT + BACK        | Press to move through frames inside the GUI.   |
| 50 SORT + BACK         | Press to sort the tracks by Beats Per Minute.  |
| 51 L.PREP              | Press to load the currently selected track to the Preview Deck.  |
| 51 SHIFT + L.PREP      | Press to start and stop playing the track in Preview Deck.   |
| 51 SORT + L.PREP       | Press to sort the tracks by their Key.   |
| 52 FILES               | Press to maximize the library. Press this button again to exit maximized library. While the library is maximized you can use the jog wheel to navigate quickly through lists.  |
| 52 SORT + FILES        | Press to sort the tracks by Artist.  |
| 53 PANEL               | Press to open and close the FX panel inside the GUI.   |
| 53 SORT + PANEL        | Press to sort the tracks by Title.   |

## Deck Section

| NoControl               | Function  |
|-------------------------|---|
| 23 DECK                 | Selects which deck in the software is controlled by that hardware deck. The left deck can control Deck 1 or 3; the right deck can control Deck 1 or 4.  |
| 23 SHIFT + DECK         | Press to switch Platter Ring LED Mode. Refer to the <a href="#">LEDs section</a> for details.   |
| 24 SHIFT                | Press and hold this button to access secondary functions of other controls.   |
| 25 SYNC                 | Press to automatically match the corresponding deck's <i>tempo</i> with the tempo and phase of the opposite deck. Press again to deactivate Sync. Hold this button down for one sec to permanently match the tempo.   |
| 26 CUE                  | If a cue point is not set then press this button to set it at the current track position. During playback, press this button to return the track to the cue point. If the deck is paused, press and hold this button to play the track from the cue point. Release the button to return the track to the cue point and pause it. To continue playback without returning to the cue point, press and hold this button and then press the PLAY button, afterwards release cue button. |
| 26 SHIFT + CUE          | Press to return to the start of the track.  |
| 27 PLAY / PAUSE         | Press to pause or resume playback.  |
| 27 SHIFT + PLAY / PAUSE | Press to stutter play the track from the last set cue point.  |

continues on next page

Table 3 – continua dalla pagina precedente

| NoControl                   | Function  |
|-----------------------------|---|
| 28 Jog Wheel                | Controls the audio playhead when the wheel is touched and moved.<br>When the VINYL button is lit, move the platter to “scratch” the track as you would with a vinyl record.<br>When the VINYL button is unlit (or if you are touching only the side of the platter), move the platter to temporarily adjust the track’s speed.<br>If the library is maximized (use FILES button) turning the jog wheel will scroll the current table view (currently playing track is not affected). Be careful though: after exiting the maximized library view the jog wheel will immediately return to jog or scratch mode.  |
| 28 SHIFT + Jog Wheel        | Navigates quickly through the track. This only applies if touching the side of the platter or with VINYL deactivated.   |
| 29 STOP TIME                | Controls the rate at which the track slows to a complete stop (“brake time”) during backspin. This also affects how quickly the track starts after a backspin (“Soft Start”).   |
| 30 VINYL                    | Press to activate/deactivate a “vinyl mode” for the platter. When activated, you can use the platter to “scratch” the track as you would with a vinyl record.   |
| 31 Pitch Fader              | Move to adjust the speed (pitch) of the track.  |
| 32 PITCH BEND –/+           | Press to momentarily reduce or increase the speed of the track.   |
| 32 SHIFT + PITCH BEND – /+  | Press to set the Pitch Fader range. You may adjust the steps in <i>JavaScript file</i>  |
| 33 KEY LOCK                 | Press to activate/deactivate Key Lock. When Key Lock is activated, the track’s key will remain the same even if you adjust its speed.   |
| 33 SHIFT + KEY LOCK         | Press to automatically match the corresponding deck’s key with the key of the opposite deck.  |
| 34 KEY SELECT/RESET         | Turn to raise or lower the key of the track. Press to reset the track’s key to its original key.  |
| 34 SHIFT + KEY SELECT/RESET | Turn to zoom in and out the waveform or push the knob to reset the Waveform zoom to the level set in preferences.   |
| 35 Performance Pads         | refer to the <i>Performance Pads section</i> for details.   |
| 40 AUTO LOOP                | Press to create an auto-loop with the length set with loop length. You may change the length of beats by using the X1/2 or X2 buttons.  |
| 40 SHIFT + AUTO LOOP        | Press to toggle the current loop on or off. If the loop is ahead of the current play position, the track will keep playing normally until it reaches the loop.  |
| 41 X1/2                     | Press to halve the length of the current loop.  |
| 41 SHIFT + X1/2             | Press to create a loop in point at the current Location.  |
| 42 X2                       | Press to double the length of the current loop.   |
| 42 SHIFT + X2               | Press to create a loop out point at the current Location.   |
| 43 </> PARAM 1 2            | Press to add/remove rating stars to the loaded track.   |
| 43 SHIFT + </> PARAM 1 2    | Press to change the track color in the library.   |
| 44 SLIP                     | Press to enable or disable Slip Mode. In Slip Mode, you can jump to cue points, trigger loops or use the platters, while the track’s timeline continues. In other words, when you deactivate Slip Mode, the track will resume normal playback from where it would have been if you had never done anything (i.e., as if the track had been playing forward the whole time).<br>After scratch, hot cue play, reverse play and backspin the slip mode releases itself so the timeline of the track jumps back to original position after the action is done. Slip mode reactivates itself after 50ms so you can continue with more actions in slip mode almost immediately after. |

continues on next page

Table 3 – continua dalla pagina precedente

| NoControl                   | Function  |
|-----------------------------|---|
| 45 CENSOR                   | Press and hold this button to play the track in REVERSE. When releasing the button, the track immediately starts playing from it's momentary position.<br>If SLIP was active then after releasing the CENSOR button the track continues as it had been playing forward the whole time (CENSOR). Slip mode stays enabled so you can continue with more actions in slip mode. |
| 45 SHIFT + CENSOR           | Press to activate a backspin with the length set by the STOP TIME knob.<br>If SLIP was active then after releasing the CENSOR button the track continues as it had been playing forward the whole time. Slip mode stays enabled so you can continue with more actions in slip mode.   |
| 46 BEAT GRID ADJUST         | Press to adjust the Beat Grid to the current play position.   |
| 46 SHIFT + BEAT GRID ADJUST | Press to activate Quantize mode.  |
| 47 BEAT GRID SLIDE          | Press to adjust the Beat Grid to another playing track.   |
| 54 NEEDLE DROP              | Place your finger on a point along this sensor to jump to that point in the track (strip represents entire track).  |
| 54 SHIFT + NEEDLE DROP      | Press to jump to a position while a track is currently playing.   |

**Suggerimento:** The jog sensitivity and scratch parameters (28), the default vinyl mode (30), the pitch fader ranges (32) as well as the needle drop activity (54) can be set by modifying the variables inside the *JavaScript file* accordingly.

**Nota:** Use SHIFT + CENSOR for a backspin while SLIP is active. Backspin using the platter is only possible while SLIP is disabled.

## Performance Pads

### Mode Selection

| NoControl           | Function   |
|---------------------|--|
| 35 Performance Pads | Press to perform action with one of those buttons.               |
| 36 CUE              | Press to switch to “ <b>Hot Cue</b> ” mode.                      |
| 37 ROLL             | Press to switch to “ <b>Roll</b> ” mode.                         |
| 37 SAVED LOOP       | Press ROLL one more time to get into “ <b>Fixed Loop</b> ” mode. |
| 38 SLICER           | Press to switch to “ <b>Beatjump</b> ” mode.                     |
| 39 SAMPLER          | Press to switch to “ <b>Sampler</b> ” mode.                      |

### Hot Cue Mode (blue LED)

8 Hot Cue positions can be defined in this mode.

Press one of the pad buttons to set or play a Hot Cue.

Use SHIFT + pad button to delete an existing Hot Cue.

If SLIP is active then press and hold a pad button to play from the Hot Cue position. After releasing the Hot Cue button the track continues as it had been playing forward the whole time. Slip mode stays enabled so you can continue with more actions in slip mode.

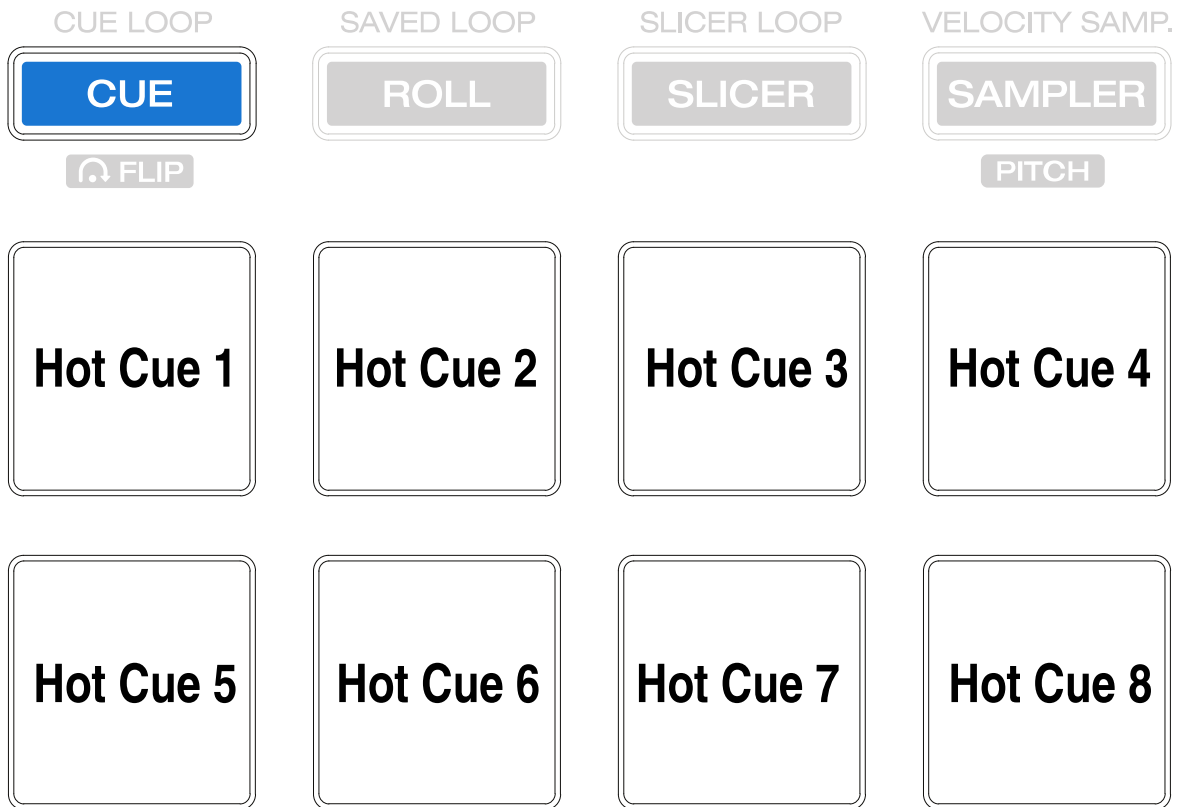

### Roll Mode (turquoise LED)

This mode lets you repeat a number of beats while keep pushing a pad button down.

The SLIP function remains active so that the track continues at the position where it had been playing forward the whole time.

### Fixed Loop Mode (yellow LED)

This mode lets you set a dedicated loop from current position.

Another push on the pad button will turn the loop off.



| CUE LOOP                       | SAVED LOOP                    | SLICER LOOP                   | VELOCITY SAMP.                |
|--------------------------------|-------------------------------|-------------------------------|-------------------------------|
| <b>CUE</b><br>FLIP             | <b>ROLL</b>                   | <b>SLICER</b>                 | <b>SAMPLER</b><br>PITCH       |
| <b>1/16 beat<br/>Loop Roll</b> | <b>1/8 beat<br/>Loop Roll</b> | <b>1/4 beat<br/>Loop Roll</b> | <b>1/2 beat<br/>Loop Roll</b> |
| <b>1 beat<br/>Loop Roll</b>    | <b>2 beat<br/>Loop Roll</b>   | <b>4 beat<br/>Loop Roll</b>   | <b>8 beat<br/>Loop Roll</b>   |

| CUE LOOP            | SAVED LOOP          | SLICER LOOP         | VELOCITY SAMP.          |
|---------------------|---------------------|---------------------|-------------------------|
| <b>CUE</b><br>FLIP  | <b>ROLL</b>         | <b>SLICER</b>       | <b>SAMPLER</b><br>PITCH |
| <b>1 beat Loop</b>  | <b>2 beat Loop</b>  | <b>4 beat Loop</b>  | <b>8 beat Loop</b>      |
| <b>16 beat Loop</b> | <b>32 beat Loop</b> | <b>64 beat Loop</b> | <b>128 beat Loop</b>    |

### Beatjump Mode (red LED)

This mode lets you jump a number of beats while pushing a pad button once.

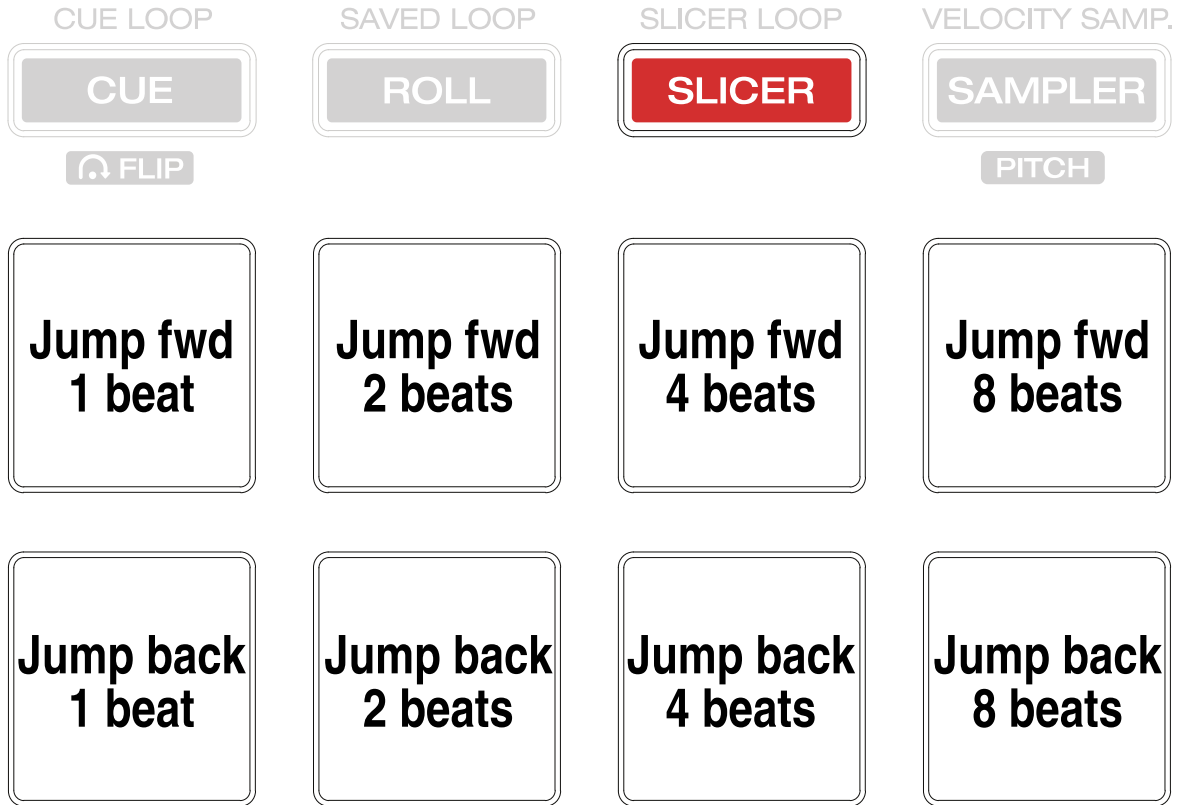

Press and hold «SHIFT» and then push a pad button to jump even more beats. 16, 32, 64 and 128 forward on the upper row and backwards on the lower row.

---

**Suggerimento:** If experimental features were set to *true* in the *JavaScript file* then the pad LEDs counting the beat **after** the main CUE point.

---

### Sampler Mode (pink LED)

8 samplers can be triggered from either Deck.

Add samplers to the sampler bank pushing a pad button.

If a sampler is loaded, then another push on the pad button will play the sampler from its Cue point.

Push the pad button again while playing will replay the sampler from Cue point.

When a sampler is started while another one is still playing, then the initial sampler stops and only the newly triggered sampler plays (single play).

Use SHIFT + pad button to stop a sampler while playing or eject a sampler when stopped.

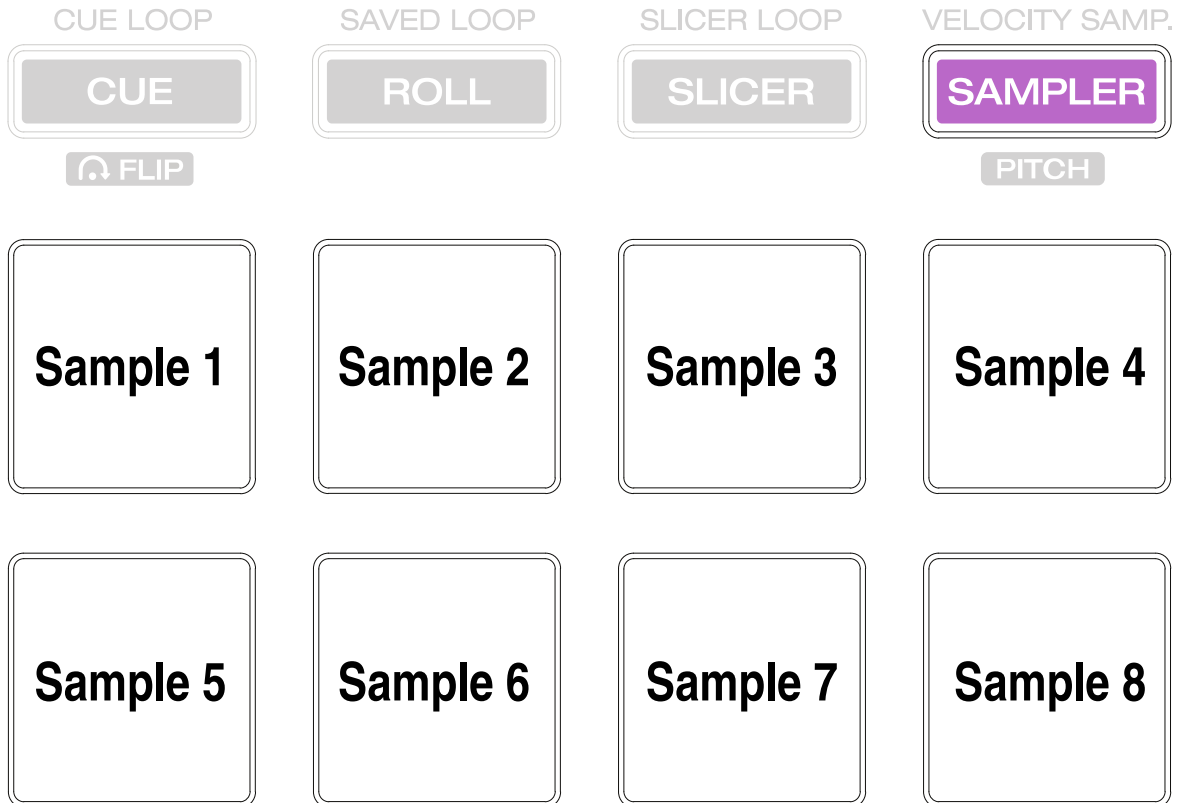

---

**Suggerimento:** To use default Mixxx behaviour and allow playing multiple samplers at the same time you can set the user variable `MC7000.prevSamplerStop` inside the *JavaScript file* to `false`.

---

## LEDs

The Channel Volume Meters matches to the ones shown in Mixxx GUI. Only when clipping the red LED illuminates.

The Master Volume Meter is not correlated to Mixxx GUI as the controller handles that in Hardware.

Button LEDs are fully mapped for the first function. As you press and hold SHIFT then the secondary functions have only got some flashing LEDs mapped, e.g. TAP and KEY SYNC, when activated.

Press SHIFT + Deck to switch Platter Ring LED Mode.

- Mode 0 - Single “off” LED chase (all other LEDs are “on”)
- Mode 1 - Single “on” LED chase (all other LEDs are “off”)

---

**Suggerimento:** The default mode can be set to 0 or 1 inside the *JavaScript file*.

---

Platter Ring LEDs are correlated with the VINYL button.

- If vinyl mode is enabled, the LED imitates a turntable platter spinning at 33.3 rpm.
- If vinyl mode is disabled, the current track position is indicated by the Platter LEDs starting at the top.

---

**Nota:** The Platter Ring LEDs are not moving while the track position is “negative”. That means if the position is before the track starts then the position LED keeps staying at most up position.

---

### Known Issues

- Some Performance Pad modes are not available (Cue Loop, Flip, Slicer Loop, Velocity Sampler, Pitch).
- The Effect Units don't use Mixxx" Standard Effects Mapping

### 17.1.20 DJ Tech CDJ 101

DJ Tech is not to be confused with DJ TechTools, the makers of the MIDI Fighter series, Chroma Cables, and Chroma Caps. There is no (longer) a product page for this discontinued device.

- [Forum thread](#)

Nuovo nella versione 1.11.

### Mapping description

Needs the CDJ 101 to be on midi channel 1 for deck 1 and on channel 2 for deck 2.

- Pitch slider works as you'd expect
- Holding down the push button works as a “shift” to activate secondary functions
- Rotate push button: navigate tracks
- Shift + rotate push button: switch between playlists
- Cue button: default cue behaviour
- Play: toggle play
- Shift + play: sync

### While track is playing

- Surface of jog wheel: scratch
- Edge of jog wheel: tempo bend
- Shift + edge of jog wheel: fine tempo bend

### While deck is paused

- Press push button: load a track
- Surface of jog wheel: scratch thru track
- Shift + surface of jog wheel: scan through track quickly
- Edge of jog wheel: jog though track slowly
- Shift + Cue: move beatgrid

#### 17.1.21 DJ Tech DJM 101

DJ Tech is not to be confused with DJ TechTools, the makers of the MIDI Fighter series, Chroma Cables, and Chroma Caps. There is no (longer) a product page for this discontinued device.

- [Forum thread](#)

Nuovo nella versione 1.11.

---

**Nota:** Unfortunately a detailed description of this controller mapping is still missing. If you own this controller, please consider [contributing one](#).

---

#### 17.1.22 DJ Tech iMix Reload

DJ Tech is not to be confused with DJ TechTools, the makers of the MIDI Fighter series, Chroma Cables, and Chroma Caps. There is no (longer) a product page for this discontinued device.

- [Forum thread](#)

Nuovo nella versione 1.10.

---

**Nota:** Unfortunately a detailed description of this controller mapping is still missing. If you own this controller, please consider [contributing one](#).

---

### 17.1.23 DJ Tech Kontrol One

DJ Tech is not to be confused with DJ TechTools, the makers of the MIDI Fighter series, Chroma Cables, and Chroma Caps. There is no (longer) a product page for this discontinued device.

- [Forum thread](#)

Nuovo nella versione 1.11.

---

**Nota:** Unfortunately a detailed description of this controller mapping is still missing. If you own this controller, please consider [contributing one](#).

---

### 17.1.24 DJ-Tech MIX-101

Nuovo nella versione 2.0.

---

**Nota:** Unfortunately a detailed description of this controller mapping is still missing. If you own this controller, please consider [contributing one](#).

---

### 17.1.25 DJ Tech Mixer One

DJ Tech is not to be confused with DJ TechTools, the makers of the MIDI Fighter series, Chroma Cables, and Chroma Caps.

- [Manufacturer's product page](#)

Nuovo nella versione 1.10.1.

---

**Nota:** Unfortunately a detailed description of this controller mapping is still missing. If you own this controller, please consider [contributing one](#).

---

### 17.1.26 DJ TechTools MIDI Fighter Classic

A simple 16 button controller that has been discontinued.

The default Mixxx mapping has the buttons mapped to hotcues 1-8 for decks 1 & 2.

Nuovo nella versione 1.8.

---

**Nota:** Unfortunately a detailed description of this controller mapping is still missing. If you own this controller, please consider [contributing one](#).

---

---

### 17.1.27 DJ TechTools MIDI Fighter Twister

- [Manufacturer's product page](#)

Nuovo nella versione 2.1.5.

---

**Nota:** Unfortunately a detailed description of this controller mapping is still missing. If you own this controller, please consider [contributing one](#).

---

### 17.1.28 EKS Otus

This controller has been discontinued as EKS is went out of business.

Nuovo nella versione 1.11.

---

**Nota:** Unfortunately a detailed description of this controller mapping is still missing. If you own this controller, please consider [contributing one](#).

---

### 17.1.29 Electrix Tweaker

The Electrix Tweaker is an unconventional MIDI controller that can control most aspects of Mixxx. Instead of jog wheels, it fits an 8x4 grid of multicolor backlit buttons, 8 velocity-sensitive buttons, and 6 push encoders with LED rings into a relatively small package. It does not have a built in sound card, so it requires a separate sound card or splitter cable (although it does include 5-pin MIDI in and out ports).

- [Manufacturer's website](#)
- [Forum topic](#)
- [Manufacturer's manual](#)

Nuovo nella versione 2.0.

#### Compatibility and setup

The Tweaker is a USB MIDI class compliant device, so it does not require any special drivers on any operating system. Just plug it in and load the Mixxx mapping on any OS that Mixxx runs on.

Use it with the Tweaker MIDI 1 port (Tweaker MIDI 2 is the 5-pin MIDI I/O on the Tweaker).

#### Mapping description

##### Global controls

1. Scroll through library. Press to toggle big library view
2. Scroll up left panel of library
3. Scroll down left panel of library
4. Samplers
  - Off when empty, red when loaded



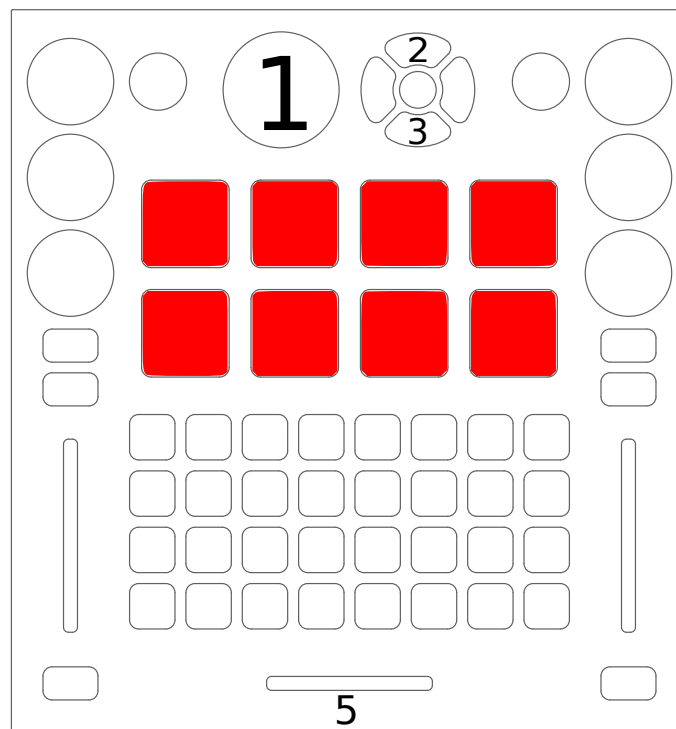

Figure13: Electrix Tweaker (global controls)

- Press a button to load the selected sample into a sampler and play it
- Press a button to play a sample. When the button is released, the sample will stop playing.
- Press [[#top-shift-layer/top shift]] and a sampler button to eject a sample from a sampler
- Samples will play with their volume proportional to how much force was used to strike the button. You can adjust the sensitivity or disable the velocity sensitivity (and make them work as on/off switches) by adjusting options at the top of the JavaScript file in a text editor.

5. Crossfader

**Top shift layer**

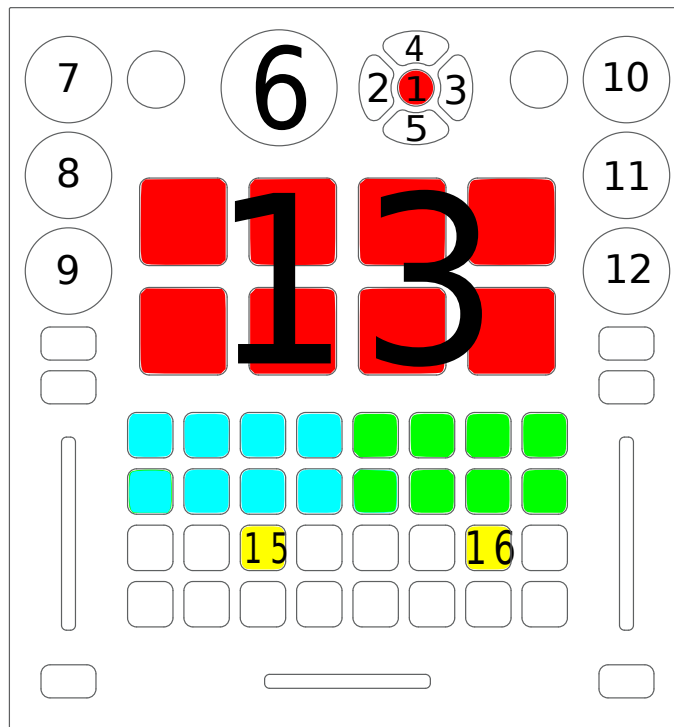

Figure14: Electrix Tweaker (top shift layer controls)

This layer is active while the top shift button (#1 in the diagram) is held down.

With the exception of the headphone mix encoder (#8 in the diagram), pressing the encoders 7-12 resets them to center.

1. Top shift button
2. Eject left deck
3. Eject right deck

4. Expand/collapse selected item in left library pane
5. Expand/collapse selected item in left library pane
6. Scroll through library quickly. Push to load selected track into first stopped deck.
7. Headphone gain
8. Headphone cue/master mix in headphones. Press to toggle split cue mode. The blue LED below encoder is lit when split cue mode is enabled.
9. Channel gain for active deck on left side
10. Master output gain
11. Master output balance
12. Channel gain for active deck on right side
13. Eject sampler
14. Delete hotcue
15. Deck shift button. Press to enable [[#vinyl timecode mode]] on the deck that is active on the left side (press top shift button first, then this button while holding down top shift)
16. Deck shift button. Press to enable [[#vinyl timecode mode]] on the deck that is active on the right side (press top shift button first, then this button while holding down top shift)

## Deck controls

The deck controls are the same on each half of the controller. Which deck each side controls can be switched with the deck toggle button, labeled #11 in the diagram. When controlling deck 1 or 2, the switches on that side (9, 11, 13, 14, and 15 in the diagram) are blue when enabled, as shown on the left side of the diagram. When controlling deck 3 or 4, the switches on that side are magenta when enabled, as shown on the right side of the diagram.

1. Filter (low pass filter left of center; high pass filter right of center)
2. Load track selected in library into deck
3. Toggle encoders between EQ and loop mode (see [[#channel-encoder-layers|below]])
4. Headphone cueing
5. Volume
6. Play/pause
7. Hotcues. Press an unlit button to set a hotcue. When slip mode is disabled (see #9 below), pressing a hotcue simply jumps to that hotcue. When slip mode is on, hotcues can be previewed on a stopped deck. While previewing a hotcue, press the play button to let the track keep playing after the hotcue is released. Pressing a hotcue while a deck is playing and slip mode is on will jump to the hotcue then jump back to where the track would have been once the last hotcue button is released.
8. Jump 4 beats forward (with quantize enabled)
9. Slip mode. When active, loops and hotcues will only play as long as they are held down. When they are released, the track will jump to where it would have been if the loop or hotcue was not pressed.
10. [[#deck-shift-layer|Deck shift]]
11. Deck toggle between decks 1 & 3 on the left and decks 2 & 4 on the right.
12. Jump 4 beats backward (with quantize enabled)

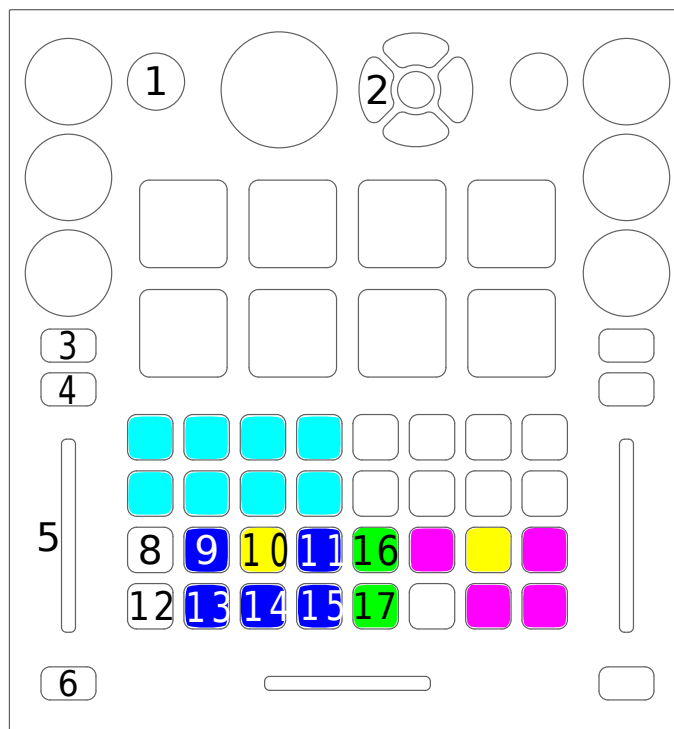

Figure15: Electrix Tweaker (deck controls)

13. Quantize. In addition to snapping cues, loops, and play button presses to the nearest beat, this changes the behavior of the controller's navigation buttons. When enabled, the navigation buttons are white as shown by 8 & 11 in the diagram. With quantize enabled, the navigation buttons jump by 4 beats or 1 beat with [#deck-shift-layer|deck shift (#10)] pressed. When disabled, the navigation buttons are green as shown by 15 & 16 in the diagram. With quantize disabled, the navigation buttons fast forward and rewind the track. When quantize is disabled and deck shift is pressed, the navigation buttons are temporary pitch bend buttons.
14. Key lock
15. Sync lock
16. Fast forward (with quantize disabled)
17. Rewind (with quantize disabled)

### Deck Shift layer

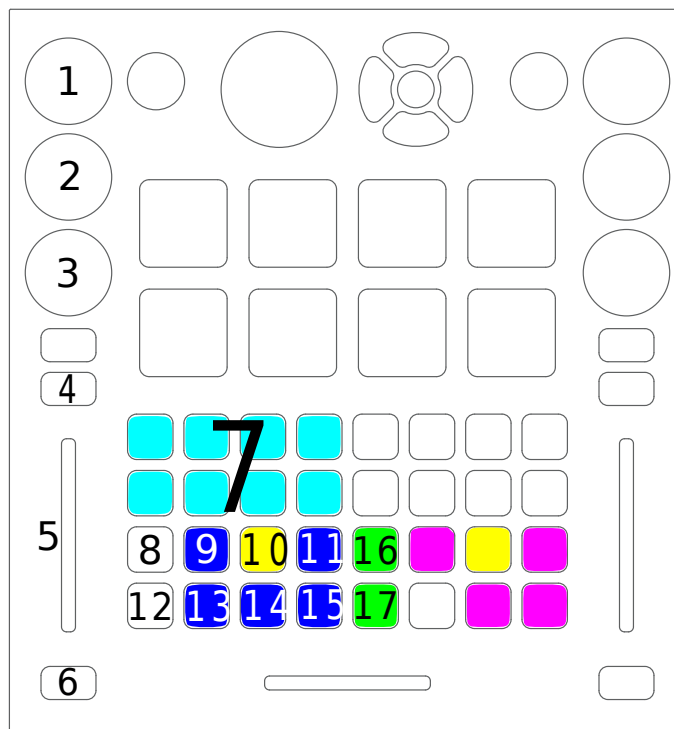

Figure 16: Electrix Tweaker (deck shift layer)

This layer is active while the yellow deck shift button on that side of the controller is held down.

1. Pitch (only adjusts tempo with keylock on)
2. Jump 32 beats forward or backward

3. Scroll through hotcue pages. The pages are color coded, in order, cyan, green, red, and white. The LED around the encoder indicates the hotcue page number. The active page on a deck is remembered when toggling between decks (see [[#deck-controls|deck controls (#11)]] above).
4. Exit loop
5. Volume
6. Cue. When previewing from the cue point on a stopped deck, release this cue button to stop playing and jump back to the cue point. Release deck shift to continue playing.
7. Move hotcue to current position
8. Jump forward 1 beat (with quantize enabled, see [[#deck-controls|deck controls #13]])
9. Manually place loop start point
10. Deck shift button
11. Manually place loop end point
12. Jump back 1 beat (with quantize enabled, see [[#deck-controls|deck controls #13]])
13. Align beatgrid with current position
14. Sync key. If key has been changed from track's original key, reset the key.
15. Reset tempo
16. Temporarily raise pitch while pressed (with quantize disabled, see [[#deck-controls|deck controls #13]])
17. Temporarily lower pitch while pressed (with quantize disabled, see [[#deck-controls|deck controls #13]])

### Channel encoder layers

The encoder layer buttons (#4 and #8 in the diagram) toggle the encoders between EQ and loop layers.

The left side of the diagram shows EQ mode. In EQ mode, pressing encoders toggles that EQ's kill switch. The blue LED below the encoder is lit while the kill switch is on. Pressing the encoder while holding deck shift (see *deck controls #10*) resets the EQ to center.

Tip: You can go to Options > Preferences > Equalizers and check "Reset equalizers on track load". On most controllers, this would be an issue because the physical knobs would be misaligned with the values in software when the EQs were reset, but because the Tweaker has LED rings around encoders instead of knobs, this is not an issue.

The right side of the diagram shows loop mode. The LEDs on the loop move length and loop length encoders represent numbers of beats. Center means 1 beat. Each step to the right doubles the beats and each step to the left halves the beats. For example, the default loop length is 4 beats, so the center LED and 2 LEDs to the right are lit ( $2 \times 2 = 4$ ).

1. High EQ
2. Mid EQ
3. Low EQ
4. Encoder mode button. Press to switch to loop mode.
5. Loop move length
6. Move loop
7. Loop length. Press to toggle loop. When in slip mode (see [[#deck-controls|deck control button #9]]), the loop is only active while this is held down. The blue LED below the encoder is lit while
  8. a loop is active.

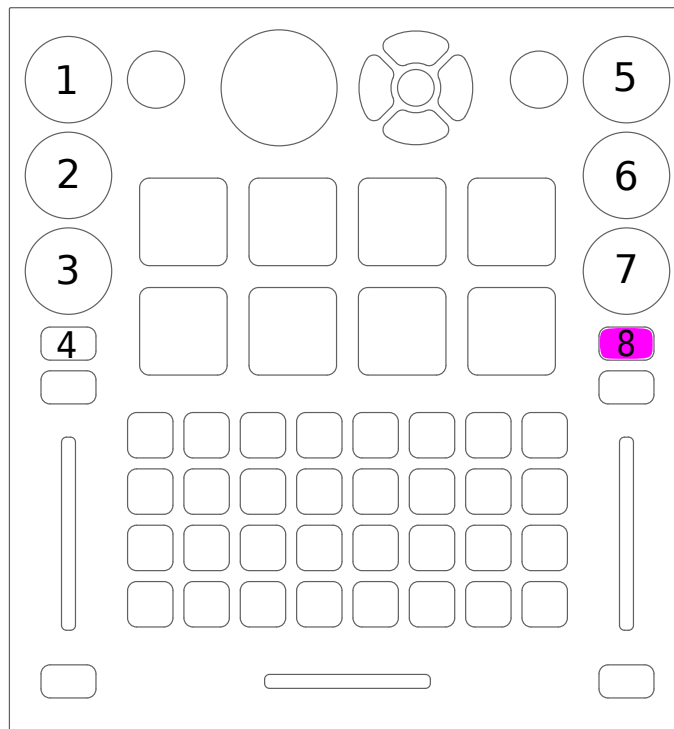

Figure17: Electrix Tweaker (channel encoder layers)

- Encoder mode button. Press to switch to EQ mode.

## Vinyl Timecode Mode

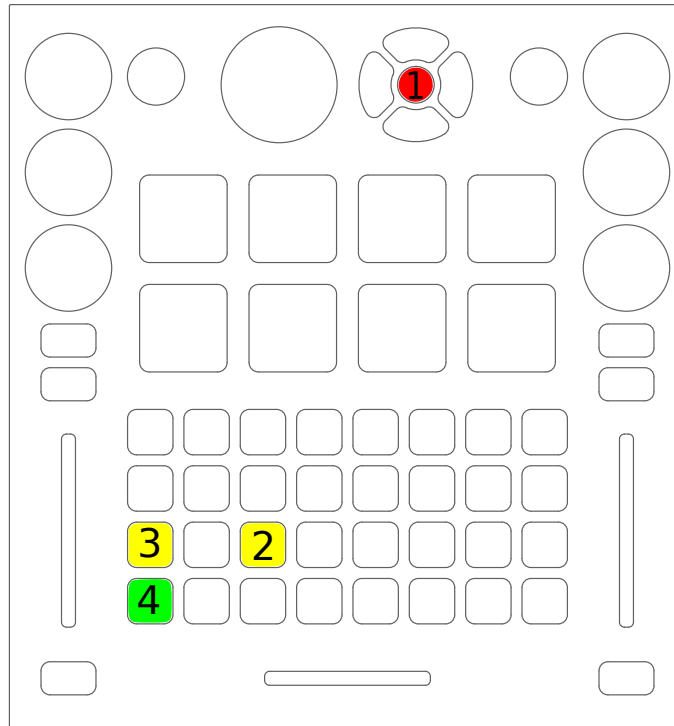

Figure18: Electrix Tweaker (vinyl timecode mode)

- Top Shift
- Toggle vinyl timecode mode by pressing deck shift (#2 in the diagram) while holding top shift (#1 in the the diagram). This replaces the navigation buttons for that deck with buttons that toggle options for timecode control.
- Cycle through vinyl control modes: absolute (LED off), relative (LED indicates cue mode), and constant (LED red). If the deck is in relative mode and playing, pressing the button cycles through cue modes: off (white), cue (yellow), hotcue (green). When the deck is playing in relative mode, pressing the button with deck shift (#2) switches to constant mode.
- toggle vinyl control. Turns green when vinyl control is enabled. With deck shift (#2) pressed, it toggles passthrough mode and turns white. Pressing the button while passthrough mode is enabled turns passthrough mode off (without toggling whether vinyl control is enabled).



### 17.1.30 Evolution X-Session

This product has been discontinued.

Nuovo nella versione 1.6.

---

**Nota:** Unfortunately a detailed description of this controller mapping is still missing. If you own this controller, please consider [contributing one](#).

---

### 17.1.31 FaderFox DJ2

- [Manufacturer's product page](#)

Nuovo nella versione 1.6.

#### Setting up the controller

In order for this mapping to work, you will need to use these settings. First, enter *System Mode* by pressing the two black buttons in the top right encoder section. There is a vertical *System* label next to these two buttons. The orange *Sys/Mon* LED in the center bottom should be on and not blinking.

You can now modify various settings by pressing each of the 4 black buttons of the encoder section. There are two possible settings for each function, *On* or *Off*, depending which of the corresponding LED is lit. There is also a brief explanation of these settings on a gray sticker in the back of the controller.

- The top left button controls the *Auto Switch* function. If the *Seek/Scratch* green LED, is on, the function is off. If the *List/load* red LED is on, the function is on. If the *Auto Switch* function is on, the encoder will switch to *Seek/Scratch* after pressing the encoder to load a track. This function is up to the user's preference and will not affect the mapping.
- **The bottom left button must be set to the Gain green LED for this mapping to work.** If set to the red *Pitch* LED, the transport buttons will have different CC numbers. This is useful if you own a second controller which already has transport functions.
- **The top right button must be set to the Seek/Scratch green LED.** If set to the *List/Load* red LED, the *Auto Play* function will be on, meaning that loading a track from the *List/load* encoder will trigger playback. You don't want this function on since it will conflict with the play button of the transport section which would have the same CC number.
- **The bottom right button must be set to the Gain green LED.** If set to the red LED, the joystick will have different CC numbers, and its mapping won't work properly.
- If the green *FX1* LED is on, the controller's will use MIDI channel 1, and channel 16 if the *FX2* LED is on. This is useful if you want to control four decks using two FaderFox DJ2 controllers. If you use only one controller, leave this setting to *FX1*. To change the setting, press the *Shift* button and the lower left black button of the encoder section for channel 1, or the lower right black button of the encoder section for channel 16.

*Important* : changes to your settings won't be saved if you just turn off the controller on *System Mode*. To save the settings, exit *System Mode* by pressing again the two black buttons of the left encoder section.

## Encoders Section

The two encoders on top of the controller control various parameters. They can of course be turned but also act as push buttons. You can select which function is used for each of the encoders by pushing the black buttons of the encoders section. LEDs indicate which function is currently selected.

- *List/Load* (top red LED is on) lets you browse your playlist. Push the left encoder to load the highlighted track into Deck A or the right encoder for Deck B.
- *Seek/Scratch* (top green LED is on) acts as a jogwheel. Turn the left encoder for Deck A or the right encoder for Deck B. Pushing the encoder on that setting will activate *Sync* on that deck.
- *Gain* (bottom green LED is on) controls the gain of the channel. Pushing the encoder on that setting will mute the track.
- *Pitch* (bottom red LED is on) controls the tempo of the deck. Unfortunately there is no MIDI CC number emitted when pushing the encoder on that position.

## Joystick

The joystick can be set to control either the first or the second unit of the effect rack. To control the first effect unit, press *Shift* + the lower black button of the left encoder section (*FX1* green LED is on). To control the second effect unit, press *Shift* + the lower black button of the right encoder section (*FX2* green LED is on).

The horizontal axis of the joystick controls the *Mix* knob of the effect unit. The vertical axis control the *Super Knob* of the unit.

## Mixer Section

- Using the knobs and faders should be straightforward as the controls follow the labels printed on the controller.
- The *Cue Mix* knob controls the headphone mix. The *Cue A* and *Cue B* are used to pre-listen the selected deck.
- The green *FX ctrl* buttons are used to activate a desired effect unit on the selected deck.
- the left green button enables effect unit 1 on that deck
- the right green button enables effect unit 2 on that deck
- *Shift* + left green button enables effect unit 3 on that deck
- *Shift* + right green button enables fx unit 4 on that deck
- The *Kill* button controls Low Kill and *Shift* + *Kill* controls High Kill. To use Mid Kill, press *Shift* + *Cue A* (Deck A) or *Shift* + *Cue B* (Deck B)

## Transport Section

The left transport section controls Deck A transport functions, and the right transport section those of Deck B.

- The top left gray button (labeled with a pause symbol) of each section controls the *Align beatgrid to current play-position* function. *Shift* + this button controls the *Quantize* function.
- The top right gray button (without any label) controls the *Keylock*. *Shift* + this button controls the *Reverse* function.
- The bottom left gray button (Play/pause label) controls *Play*. *Shift* + this button will make the playback jump one beat backward on this deck.
- The bottom right gray button (play label) controls *Cue* (depending on the settings in Mixxx's preferences). *Shift* + this button will make the playback jump one beat forward on this deck.

- The top blue button holds down the speed (temporary pitch bend) and the bottom blue button holds the speed up according to the labels on the controller. Pressing *Shift* + these blue buttons will act similarly but with a smaller pitch bending.

### 17.1.32 Gemini CDMP-7000

- [Manufacturer's product page](#)

Nuovo nella versione 2.0.

---

**Nota:** Unfortunately a detailed description of this controller mapping is still missing. If you own this controller, please consider [contributing one](#).

---

### 17.1.33 Gemini FirstMix

- [Manufacturer's product page](#) (archived)
- [Forum thread](#)

Nuovo nella versione 1.11.

---

**Nota:** Unfortunately a detailed description of this controller mapping is still missing. If you own this controller, please consider [contributing one](#).

---

### 17.1.34 Hercules DJ Console 4-Mx

The Hercules DJ Console 4-Mx is a USB controller with a built in sound card. It is very similar to the [[Hercules DJ Console RMX]], but with switches for 4 decks.

- [Manufacturer's product page](#)

Nuovo nella versione 1.11.

#### Audio

The DJ Console 4-Mx is not a USB class compliant MIDI device, although it is a USB Audio device. Drivers for Mac OS X and Windows can be found on the [Hercules support page](#).

**Avvertimento:** The controller will not work on Linux out of the box. You will need to use the [Linux usermode driver](#). The device will only produce audio if the device hasn't been configured for ASIO under windows previously. Also, check the volumes in alsamixer.

The sound card has 4 inputs and 4 outputs (2 stereo in/out). The inputs are switchable between line-in and phono, and also is possible to select different line levels (consumer -10dBV, Pro +4dBu and boost +8dBu ), so you can connect both CD players and turntables on the inputs. \* Inputs are RCA. \* Outputs are RCA or 1/4» TRS balanced. \* Microphone input is 1/4» TS \* Headphone jack is 1/4» (6.35 mm) TRS stereo

## Hercules Tray Icon configuration

The drivers for Windows and OS X install an application that can be used to configure the audio and controller settings. Most of the settings work well on the default setting.

- **Volume/Pan/Mute:** Sets the volume output for channels 1-2 and channels 3-4. Note that the volume of the channels 3-4 refers to the line output from behind. In other words. It does not affect the volume of the headphones.
- **Line in mode:** Sets the line level of the inputs. In case of line 1-2, it also allows to redirect the microphone to the line 1-2. Else, it is mixed in hardware to the master out.
- **Talkover attenuation:** Sets how much to attenuate the master output when activating the hardware mixed microphone.
- **Enable/Disable jog wheels:** Allows to disable the jog wheels, in case the user desires not to use them.
- **Sensitivity:** Alters the sensitivity of the jog wheels. If you change this, change also the sensitivity option in the script, as described below.
- **Audio Mode:** Enables the WDM drivers (non-asio) or the specific ASIO-only driver.
- **MIDI pitch resolution:** Sets the resolution of the pitch sliders. Mixxx will work with any of the two settings, but it is recommended to set it to 14bit (8bit used) which doubles the precision versus 7bit.
- **ASIO:** You can configure the samplerate, bit depth and latency for the ASIO driver.
- **MIDI channel for controls:** *Keep these at 1-2 (Default) when you use it with Mixxx.*
- **Crossfader settings:** Allows to configure how does the crossfader react. Mixxx also offers an alternate invert option in the crossfader settings.
- **Headphone channels:** Allows to setup which input channels are sent to the headphone output.
- **Channels 1-2 hardware mix:** Allows mixing the line in or the microphone directly in hardware to the speaker output.
- **Deck mode:** *Leave this at 4 Decks (Default) if you want to use four decks with Mixxx. Else, you will only be able to use two decks.*

## Options

There are several options that can be configured for this mapping. You can edit these by opening the JavaScript file in a text editor like Notepad, TextEdit, or gEdit and editing the values at the top of the file.

- **autoHeadMix:** Indicates if the Headphone/Master mix should automatically be set to master when none of the headphone cue buttons are activated.
- **autoHeadcueOnLoad:** Automatically enable the headphone cue select (PFL) of the deck when a song is loaded. (Like in virtual-dj)
- **beatFlashLed:** set which LED, if any, blinks with the beat
- **useVuMeters:** Simulate vuMeters using the kill and source buttons' LEDs. If enabled, shows master VUs, or deck VU depending if prefader listen button is enabled or not.
- **naviScrollSpeed:** KeyRepeat speed for navigating up/down, in milliseconds. 100 is a good value. Lower values make it scroll faster.
- **crossfaderScratchCurve:** The controller has two modes to report the crossfader position. The default/beatmix curve, and the scratch curve. The default curve reports the real position of the control. The scratch curve just crossfades on the edges. Setting this setting to true, the curve will change to scratch curve when the scratch mode is on (scratch button). Setting it to false will not change it, so it will use the setting configured in the DJHercules Tray-icon configuration.

- **vinylSpeed:** Playback speed of the virtual vinyl that is being scratched. 45.00 and 33.33 are the common speeds. (Lower number equals faster scratch)
- **sensitivity:** Jog wheel sensitivity. You should configure this setting to the same value than in the DJHercules tray icon configuration. (Normal means 1/1). If crossfaderScratchCurve is true, or the setting is changed while Mixxx is active, this value will be detected automatically.
- **alpha:** alpha value for the scratch filter (start with 1/8 (0.125) and tune from there)
- **beta:** beta value for the scratch filter (start with alpha/32 and tune from there)
- **FXbuttonsSetup:** This indicates which mapping for the FX buttons should Mixxx use. The possible values are: mixxx21, mixxx20, and original (Hercules Manual and the default setup in Virtual DJ 7 LE)

### Master / Global controls

| Control         | Mode      | Function   |
|-----------------|-----------|--|
| Cross-Fader     |           | Fades between left and right decks   |
| Vol. Main       |           | Controls the Master volume knob of Mixxx.  |
| Scratch         |           | Toggles scratch mode. When scratch mode is enabled, pressing a jog wheel controls scratching   |
| Auto            |           | Enable AutoDJ. Stop decks 1 and 2 to disable it using the controller.  |
| Auto            | AutoDJ on | Fade to next song.   |
| Folders / Files |           | Switches between browsing the sidebar in the library, or the list. If Folders is pressed twice, opens/closes the tree branch   |
| Files           | AutoDJ on | The next song in the Auto DJ cue is skipped  |
| Up / Down       |           | Moves up and down in the library track list. If held down and any of the jog wheels is moved, then the jog wheel takes over the cursor movement until the up/down button is released   |
| Cue/Mix         |           | Control mix of master and PFL (cue) output in headphones   |
| Mic On/Off      |           | Enables or disables the microphone. The microphone is always mixed in hardware. The trayicon driver configuration allows to choose between direct mixing, or mix it only when enabled with the button. It no longer tries to activate Mixxx microphone talkover. |

Note: The Microphone volume and the Headphone volume controls are hardware controls (i.e. they don't control Mixxx's interface)

### Deck / Channel specific controls

| Control    | Mode  | Function  |
|------------|-------|---|
| Shift key  |       | When this button is pressed and released, it toggles between keypad functions   |
| Shift key  |       | When this button is pressed and released, it toggles between keypad functions   |
| Play/Pause |       | Play track if it is not playing; pause it if track is playing                   |
| Play/Pause | Shift | Play backwards. If slip mode is enabled (triangle image in Deere skin), it will |
| Stop       |       | Moves the cursor to the beginning, or to the cue point if it is set, and stops  |

| Control                     | Mode                       | Function  |
|-----------------------------|----------------------------|---|
| Stop                        | Shift                      | Brake (Slow it down progressively). Releasing it will continue playing, except    |
| Cue                         |                            | Depends on the cue mode set in Mixxx preferences                                  |
| Jog wheel                   |                            | Seeks forwards and backwards in a stopped track Temporarily changes the           |
| Jog wheel                   | Scratch on and jog pressed | If Scratch is on and the jog is pressed, moving it will do a scratch effect       |
| Jog wheel                   | Up/Down pressed            | Moves up / down in the tracklist if either Up or Down are held down               |
| Jog wheel                   | LED                        | If the beatflash led has been set to jogwheel in the JavaScript file, the light   |
| Forward / Backward          |                            | Seeks at high speed.  |
| Forward / Backward          |                            | Seeks forward or backward in the track in steps of 4 beats (when the beatgr       |
| Forward / Backward          | Pressed for 500ms          | seeks at high speed.  |
| Forward / Backward          | Shift                      | Seeks forward or backward in the track in steps of 1 beats                        |
| Sync                        |                            | Automatically sets the pitch fader speed to match the BPM of the other de         |
| Sync                        | LED                        | If the beatflash led has been set to Sync in the JavaScript file, the light of th |
| Sync                        | Pressed for 500ms          | Activates master sync for this deck.  |
| Sync                        | Shift                      | Activates the beatgrid edit mode  |
| Sync                        | Beatgrid edit mode         | When the track is stopped, aligns the beatgrid with the current playback po       |
| Pitch fader                 |                            | Adjusts playback speed (range and direction can be adjusted in Mixxx prefer       |
| Pitch bend +/-              |                            | Adjusts playback speed temporarily (range can be adjusted in Mixxx prefer         |
| Pitch bend +/-              | Beatgrid edit mode         | Increases or decreases the BPM of the track (the detected one).                   |
| Pitch bend +/-              | Shift                      | Adjust playback speed permanently (range can be adjusted in Mixxx prefer          |
| Pitch Scale +/-             |                            | These controls have a different meaning in Mixxx: They have been mapped           |
| Pitch Scale +/-             | Beatgrid edit mode         | Move the beatgrid to the left or to the right                                     |
| Pitch Scale -               | Shift                      | Activates or deactivates the (musical) keylock mode                               |
| Pitch Scale +               | Shift                      | Activates or deactivates the quantize (to beat) mode                              |
| Pitch Reset                 |                            | This is triggered when both pitch scale buttons are pressed at the same time      |
| Pitch Reset                 | LED                        | This led has a different meaning in Mixxx: If the beatflash led has been set      |
| Deck A/C, B/D               |                            | Switches the deck to control between Deck A/C or between Deck B/D. Lig            |
| Vol. Deck                   |                            | Controls a deck's output volume   |
| Cue Select Deck             |                            | Toggles on and off this deck's output to the monitor/prefader listen (headph      |
| Cue Select Deck             | Shift                      | Set this deck to control the "Preview Deck". Press it again to leave this mo      |
| Cue Select Deck             | LED                        | The led is active when the monitoring with headphones is active. The butto        |
|                             | Load On Left/Right Deck    |   |
| Bass knob                   |                            | EQ low frequencies  |
| Medium knob                 |                            | EQ mid frequencies  |
| Treble knob                 |                            | EQ high frequencies   |
| Gain                        |                            | Controls a deck's gain before the volume fader                                    |
| Kill (Bass/ Medium/ Treble) |                            | Toggles that frequency band completely off  |
| Kill (Bass/ Medium/ Treble) | LED                        | If the useVuMeters option is activated in the JavaScript file, these LEDs wi      |
| Source 1/2                  |                            | Toggles the deck to use the input channel 1/2 as its audio source instead of      |
| Source 1/2                  | LED                        | If the vumeter is activated in the JavaScript file, they will show a vumeter o    |
| Keypad 1 to 4               |                            | Set/Unset a beatloop of 0.5, 1, 2 or 4 beats. They act like the corresponding     |
| Keypad 1 to 4               | Shift                      | Set/Unset a beatloop. buttons 1 and 2 use a beatloop size of 0.125 and 0.25       |
| Keypad 5 to 6               |                            | Reveses playback direction when held down. keypad 6 does it with audio r          |
| Keypad 7 to 10              |                            | Set/Unset the hotcues 1 to 4  |
| Keypad 7 to 10              | Shift                      | The corresponding hotcue is cleared   |
| Keypad 11 to 12             |                            | Enables the effect rack 1 and 2 for this specific deck                            |
| Keypad 1                    |                            | Sets the loop begin and Activates the loop edit mode                              |
| Keypad 1                    | Shift                      | Same as click, but it will be a rolling loop (slip mode)                          |
| Keypad 1                    | Loop edit mode             | Exits the loop edit mode  |
| Keypad 1                    | Loop active                | Disable the loop  |

| Control         | Mode                    | Function  |
|-----------------|-------------------------|---|
| Keypad 1        | LED                     | The led is on if the loop is active   |
| Keypad 2        |                         | Reloop (Enable or disable the previously existing loop)                         |
| Keypad 2        | Loop edit mode          | Sets the loopend and exits the loop edit mode                                   |
| Keypad 2        | LED                     | The led is on if a loop exists  |
| Keypad 3 to 4   |                         | Sets a loop of 4 or 16 beats.   |
| Keypad 3 to 4   | Shift                   | Same as click, but it will be a rolling loop (slip mode)                        |
| Keypad 3 to 4   | LED                     | If a beatloop of 1 or 4 beats is enabled.                                       |
| Keypad 5 to 6   |                         | starts or stops a sampler 1 or 2 (buttons on the left deck), or the sampler 3   |
| Keypad 3 to 6   | Loop edit mode          | Sets a beatloop of 2, 8, 16 or 32 beats   |
| Keypad 7 to 10  |                         | Set/Unset the hotcues 1 to 4  |
| Keypad 7 to 10  | Shift                   | The corresponding hotcue is cleared   |
| Keypad 11 to 12 |                         | Enables the effect rack 1 or 2 for this specific deck                           |
| Fx knob         |                         | Filter knob (the Quick Effect set in the equalizer preferences)                 |
| Fx knob         | Shift                   | Move the filter knob slowly (the Quick Effect set in the equalizer preferences) |
| Fx knob         | Beatgrid edit mode      | Move the beatgrid position  |
| Fx knob         | Loop edit mode          | Increase or decrease the loop size  |
| Fx knob         | audio effect pressed    | If a keypad number is mapped to an audio effect, holding such button and m      |
| Fx knob         | pitch Scale +/- pressed | Increases or decreases the musical key (it doesn't matter which of the pitch    |
| Fx knob         | Loop edit mode          | Move the loop forward or backward in steps of one beat                          |
| Fx knob         | keypad 1 held down      | Increase or decrease the loop size  |

Note: The actions of the Keypad buttons can be changed from the JavaScript. There are three preconfigured presets corresponding to Manual/Virtual DJ LE, Mixxx 2.0 and Mixxx 2.1.

### 17.1.35 Hercules DJ Console (Mac Edition)

Nuovo nella versione 1.7.

**Nota:** Unfortunately a detailed description of this controller mapping is still missing. If you own this controller, please consider [contributing one](#).

### 17.1.36 Hercules DJ Console MK1

Nuovo nella versione 1.11.

**Nota:** Unfortunately a detailed description of this controller mapping is still missing. If you own this controller, please consider [contributing one](#).

### 17.1.37 Hercules DJ Console MK2

Nuovo nella versione 1.11.

---

**Nota:** Unfortunately a detailed description of this controller mapping is still missing. If you own this controller, please consider [contributing one](#).

---

### 17.1.38 Hercules DJ Console MK4

Nuovo nella versione 1.8.

---

**Nota:** Unfortunately a detailed description of this controller mapping is still missing. If you own this controller, please consider [contributing one](#).

---

### 17.1.39 Hercules DJ Console RMX

- [Manufacturer's product page](#)

The Hercules DJ Console RMX is a USB controller with a built in sound card. It is a class compliant USB Audio and HID device. Older versions of Mixxx that did not support HID required using Hercules' MIDI driver, but it is now recommend to not use the Hercules driver on GNU/Linux. If you have it installed, it is recommended to uninstall the driver and upgrade to the [latest version of Mixxx](#) if you have not already. On Windows (and Mac OS X?) the driver is still recommended.

Nuovo nella versione 1.11.

#### Audio

The sound card has 4 inputs and 4 outputs (2 stereo in/out). The inputs are switchable between line-in and phono, so you can connect both CD players and turntables on the inputs. The inputs require a high input signal (~10mV+) for turntables if you want to record audio or mix it to the output. Time-coded vinyls, for Vinyl Control, should work okay with lower input signal.

#### MIDI Mappings

##### Regular mapping



## Global controls

| Control      | Function  |
|--------------|---|
| Cross-Fader  | Fades between left and right deck   |
| Vol. Main    | Controls output volume of your mix  |
| Balance      | Controls balance between left and right audio channel of your mix   |
| Scratch      | Toggles scratch on and off which changes the function of the deck jog wheels <b>Effect Shift</b> when held down shifts function of each decks Bass, Medium, Treble to control effect parameters |
| Up / Down    | Moves up and down in the library track list When held down changes the jog wheels behaviour to scroll the library list  |
| Left / Right | Moves up and down between the library sections  |
| Monitor      | Fades monitor output (headphones) between cue selected tracks output and the main mix   |

## Deck / Channel specific controls

| Control                       | Function   |
|-------------------------------|--|
| Play/Pause                    | Starts playing a loaded track if stopped. If track is currently playing it stops the track   |
| Stop                          | Stops a currently playing track and moves to the beginning.  |
| Cue                           | Sets the cue point if a track is stopped and not at the current cue point Stops track and returns to the current cue point if a track is playing. Plays preview if a track is stopped at the cue point for as long as it's held down           |
| Jog wheel                     | Seeks forwards and backwards in a stopped track Temporarily changes the playback speed for playing tracks Scratches both stopped and playing tracks when scratch mode is on Moves up / down in the tracklist if either Up or Down is held down |
| Forward / Backward            | Seeks at high speed in a track   |
| Load Deck A/B                 | Loads the currently selected track in the track list to the related deck   |
| Cue Select                    | Toggles this decks output to the monitor (headphones) on and off   |
| Pitch                         | Adjusts playback speed +/-10% (can be adjusted in the preferences)   |
| Sync                          | Automatically sets pitch so the BPM of the other deck is matched   |
| Pitch Reset                   | Resets the pitch to the tracks normal playback speed   |
| Bass                          | Adjusts the volume of a channels low frequency content (ex. bass drum) Adjusts flanger period when Effect Shift is held down   |
| Medium                        | Adjusts the volume of a channels mid frequency content (ex. vocals) Adjusts flanger delay when Effect Shift is held down   |
| Treble                        | Adjusts the volume of a channels high frequency content (ex. hi-hats) Adjusts flanger depth when Effect Shift is held down   |
| Kill (Bass / Medium / Treble) | Toggles output of a frequency band on and off  |
| Gain                          | Controls a decks input volume  |
| Vol. Deck A/B                 | Controls a decks output volume   |
| Keypad 1                      | Toggles a channels flanger effect on and off   |
| Keypad 4                      | Reverses playback direction when held down   |

## Advanced mapping

The advanced mapping works similar to the normal RMX mapping, but also supports loops and hot cues. This mapping was added to not brake the previous (Mixxx -1.7.2) behaviour. Controls that differ between the normal and advanced mappings are described here.

## Global controls

| Control | Function  |
|---------|---|
| Scratch | Toggles scratch on and off which changes the function of the deck jog wheels <b>Effect Shift</b> when held down:<br>- Shifts function of each decks Bass, Medium, Treble to control effect parameters - Shifts the Keypad (1-6) functions to effects. Currently flanger and reverse |

## Deck / Channel specific controls

| Control            | Function  |
|--------------------|---|
| Stop               | <b>Deck shift</b> changes behaviour of other controls related to this deck when held down   |
| Forward / Backward | Adjusts position of loop in/out and hot cues when a loop / hot cue button is held down  |
| Bass               | Adjusts the volume of a channels low frequency content (ex. bass drum) Soft takeover when Deck Shift is held down, lets you move knob in position before adjusting Adjusts flanger period when Scratch is held down |
| Medium             | Adjusts the volume of a channels mid frequency content (ex. vocals) Soft takeover when Deck Shift is held down, lets you move knob in position before adjusting Adjusts flanger delay when Scratch is held down     |
| Treble             | Adjusts the volume of a channels high frequency content (ex. hi-hats) Soft takeover when Deck Shift is held down, lets you move knob in position before adjusting Adjusts flanger depth when Scratch is held down   |
| Keypad 1           | Go to hotcue 1 Set hotcue 1 when Deck Shift is held down Toggles a channels flanger effect on and off when Effect Shift is held down  |
| Keypad 2           | Go to hotcue 2 Set hotcue 2 when Deck Shift is held down  |
| Keypad 3           | Go to hotcue 3 Set hotcue 3 when Deck Shift is held down  |
| Keypad 4           | Hold down to adjust loop in position with Forward / Backward Set loop in when Deck Shift is held down Reverses playback direction when held down if Effect Shift is held down                                       |
| Keypad 5           | Hold down to adjust loop out position with Forward / Backward Set loop out when Deck Shift is held down   |
| Keypad 6           | Re-loop / exit turns looping on and off Half loop when Deck Shift is held down  |

### 17.1.40 Hercules DJ Console RMX2

- [Manufacturer's product page](#)
- [Forum thread](#)
- [Previous forum thread](#)

This all-in-one DJ controller features a built in 4 channel sound card with balanced XLR master outputs and a balanced microphone input. It is a USB class compliant MIDI and audio device (unlike older Hercules controllers).

Nuovo nella versione 1.11.

#### User Options

To change the mapping's user options, you have to open the script file (`.js`). *At the top of the file under **\*\*USER OPTIONS\*\**** the following settings can be made:

- **DJCRMx2.jogwheelSensitivity**: Sets the jogwheel sensitivity. 1 = default, 2 is twice as sensitive, 0.5 is half as sensitive.
- **DJCRMx2.jogwheelShiftMultiplier**: Sets how much more sensitive the jogwheels get when holding [**SHIFT**]. Set it to 1 to disable jogwheel sensitivity increase when holding [**SHIFT**].
- **DJCRMx2.twinkleVumeterAutoDJOn**: If true, level-meter twinkles if *AutoDJ* is enabled.
- **DJCRMx2.autoPFL**: If true, PFL / Cue (headphone) is being activated by loading a track into certain deck.

- **DJCRMX2.vuMeterOutputMaster:** If true, deck vu meters show master output (L = Deck A, R = Deck B). If false, deck vu meter shows deck output (mono).
- **DJCRMX2.showHideSamplersEffectsOnPadMode:** If true, *Samplers* and *EffectRack* get shown or hidden depending on the Pad-Mode.

## General Functions

### Managed by Mixxx

| Figure     | [SHIFT]? | Long-press? | Control Name   | Description  |
|------------|----------|-------------|----------------|--|
| 11         | ✗        | ✗           | [MAIN VOL-UME] | Controls <i>Master</i> volume                            |
| 13         | ✗        | ✗           | [VINYL]        | Split headcue  |
| 13         | ✓        | ✗           | [VINYL]        | Maximize library   |
| 20         | ✗        | ✗           | [CROSS FADER]  | Controls crossfader                                      |
| 21         | ✗        | ✗           | [CUE TO MIX]   | Controls mix in headphones between PFL and master signal |
| 7          | ✗        | ✗           | [MIC ON/OFF]   | Toggle microphone on/off and talkover on/off             |
| 15 (Right) | ✗        | ✗           | [FILES]        | Go To Item in Library                                    |
| 15 (Right) | ✓        | ✗           | [FILES]        | Add to bottom of Auto DJ playlist                        |
| 15 (Left)  | ✗        | ✗           | [FOLDERS]      | Move focus backward in Library                           |
| 15 (Left)  | ✓        | ✗           | [FOLDERS]      | Toggle Auto DJ   |
| 15 (Up)    | ✗        | ✗           | [UP]           | Move vertically up in Library                            |
| 15 (Up)    | ✗        | ✓           | [UP]           | Scroll vertically up in Library                          |
| 15 (Down)  | ✗        | ✗           | [DOWN]         | Move vertically down in Library                          |
| 15 (Down)  | ✗        | ✓           | [DOWN]         | Scroll vertically down in Library                        |

### Managed by the controller

The following functions directly affect the controller's sound card, so adjusting these will not change anything on screen in Mixxx:

| Figure | [SHIFT]? | Long-press? | Control Name        | Description                           |
|--------|----------|-------------|---------------------|---------------------------------------|
| 22     | ✗        | ✗           | [HEADPHONES VOLUME] | Controls the headphones output volume |
| 6      | ✗        | ✗           | [MIC VOLUME]        | Controls the microphone volume (gain) |

Deck Functions

| Figure    | [SHIFT]? | Long-press? | Control Name          | Description   |
|-----------|----------|-------------|-----------------------|---|
| 3 (-)     | ✗        | ✗           | [PITCH BEND MINUS]    | Pitch bend down   |
| 3 (-)     | ✓        | ✗           | [PITCH BEND MINUS]    | Decrement (halve) pitch range   |
| 3 (+)     | ✗        | ✗           | [PITCH BEND PLUS]     | Pitch bend up   |
| 3 (+)     | ✓        | ✗           | [PITCH BEND PLUS]     | Increment (double) pitch range  |
| 2 (Left)  | ✗        | ✗           | [REWIND]              | Fast backward in loaded track   |
| 2 (Left)  | ✓        | ✗           | [REWIND]              | <i>Spinback</i> effect  |
| 2 (Right) | ✗        | ✗           | [REWIND]              | Fast forward in loaded track  |
| 2 (Right) | ✓        | ✗           | [REWIND]              | <i>Brake</i> effect   |
| 9         | ✗        | ✗           | [SOURCE]              | Toggle pass thru  |
| 17        | ✗        | ✗           | [PREVIEW]             | Toggle pfl  |
| 17        | ✓        | ✗           | [PREVIEW]             | Toggle keylock  |
| 30        | ✗        | ✗           | [PLAY]                | Play Button   |
| 30        | ✓        | ✗           | [PLAY]                | Play Button   |
| 29        | ✗        | ✗           | [CUE]                 | Cue Button  |
| 29        | ✓        | ✗           | [CUE]                 | Cue Button  |
| 28        | ✗        | ✗           | [SYNC]                | Sync Button   |
| 28        | ✓        | ✗           | [SYNC]                | Sync Button   |
| 16        | ✗        | ✗           | [LOAD]                | Load selected track   |
| 16        | ✓        | ✗           | [LOAD]                | Eject track   |
| 8         | ✗        | ✗           | [LOOP MODE] encoder   | Adjust beatloop size  |
| 8         | ✓        | ✗           | [LOOP MODE] encoder   | Move loop forward/backward  |
| 8         | ✗        | ✗           | [FX MODE] encoder     | EffectUnit's mix knob, in <i>EffectFocusMode</i> in combination w       |
| 8         | ✓        | ✗           | [FX MODE] encoder     | EffectUnit's super knob   |
| 8         | ✗        | ✗           | [SAMPLE MODE] encoder | Switch between 4 sampler banks (each of 4 samplers)                     |
| 8         | ✗        | ✗           | [CUE MODE] encoder    | Adjust key of loaded track  |
| 24-1      | ✗        | ✗           | [LOOP PAD 1]          | Toggles beatloop over beatloop size                                     |
| 24-2      | ✗        | ✗           | [LOOP PAD 2]          | Toggles beatloop over 2 beats   |
| 24-3      | ✗        | ✗           | [LOOP PAD 3]          | Toggles beatloop over 4 beats   |
| 24-4      | ✗        | ✗           | [LOOP PAD 4]          | Toggles beatloop over 8 beats   |
| 24-1      | ✓        | ✗           | [LOOP PAD 1]          | Toggles beatlooproll over 1/16 beats                                    |
| 24-2      | ✓        | ✗           | [LOOP PAD 2]          | Toggles beatlooproll over 1/8 beats                                     |
| 24-3      | ✓        | ✗           | [LOOP PAD 3]          | Toggles beatlooproll over 1/4 beats                                     |
| 24-4      | ✓        | ✗           | [LOOP PAD 4]          | Toggles beatlooproll over 1/2 beats                                     |
| 24-1      | ✗        | ✗           | [FX PAD 1]            | Enables effect 1, in <i>EffectFocusMode</i> toggles effect button par   |
| 24-2      | ✗        | ✗           | [FX PAD 2]            | Enables effect 2, in <i>EffectFocusMode</i> toggles effect button par   |
| 24-3      | ✗        | ✗           | [FX PAD 3]            | Enables effect 3, in <i>EffectFocusMode</i> toggles effect button par   |
| 24-4      | ✗        | ✗           | [FX PAD 4]            | Shows/hides focus of EffectUnit   |
| 24-1      | ✗        | ✓           | [FX PAD 1]            | In <i>EffectFocusMode</i> enables <i>ParameterEditMode</i> and gives en |
| 24-2      | ✗        | ✓           | [FX PAD 2]            | In <i>EffectFocusMode</i> enables <i>ParameterEditMode</i> and gives en |
| 24-3      | ✗        | ✓           | [FX PAD 3]            | In <i>EffectFocusMode</i> enables <i>ParameterEditMode</i> and gives en |
| 24-4      | ✗        | ✓           | [FX PAD 4]            | Enables <i>EffectFocusMode</i> (+ press [FX PAD 1..3] to focus an       |
| 24-1      | ✓        | ✗           | [FX PAD 1]            | Enables effect 1 of EffectUnit and controls meta its meta kno           |
| 24-2      | ✓        | ✗           | [FX PAD 2]            | Enables effect 2 of EffectUnit and controls meta its meta kno           |
| 24-3      | ✓        | ✗           | [FX PAD 3]            | Enables effect 3 of EffectUnit and controls meta its meta kno           |
| 24-4      | ✓        | ✗           | [FX PAD 4]            | Cycle through <i>effectUnit</i> numbers array                           |
| 24-1      | ✗        | ✗           | [SAMPLE PAD 1]        | Load selected track into Sampler (Index 1) if empty, else go            |
| 24-2      | ✗        | ✗           | [SAMPLE PAD 2]        | Load selected track into Sampler (Index 2) if empty, else go            |

Table 5 – continua dalla pagina precedente

| Figure | [SHIFT]? | Long-press? | Control Name   | Description   |
|--------|----------|-------------|----------------|---|
| 24-3   | ✗        | ✗           | [SAMPLE PAD 3] | Load selected track into Sampler (Index 3) if empty, else go    |
| 24-4   | ✗        | ✗           | [SAMPLE PAD 4] | Load selected track into Sampler (Index 4) if empty, else go    |
| 24-1   | ✓        | ✗           | [SAMPLE PAD 1] | Stop Sampler (Index 1) if playing, else eject loaded track      |
| 24-2   | ✓        | ✗           | [SAMPLE PAD 2] | Stop Sampler (Index 2) if playing, else eject loaded track      |
| 24-3   | ✓        | ✗           | [SAMPLE PAD 3] | Stop Sampler (Index 3) if playing, else eject loaded track      |
| 24-4   | ✓        | ✗           | [SAMPLE PAD 4] | Stop Sampler (Index 4) if playing, else eject loaded track      |
| 24-1   | ✗        | ✗           | [CUE PAD 1]    | Hotcue 1 Button   |
| 24-2   | ✗        | ✗           | [CUE PAD 2]    | Hotcue 2 Button   |
| 24-3   | ✗        | ✗           | [CUE PAD 3]    | Hotcue 3 Button   |
| 24-4   | ✗        | ✗           | [CUE PAD 4]    | Hotcue 4 Button   |
| 24-1   | ✓        | ✗           | [CUE PAD 1]    | Hotcue 1 Button   |
| 24-2   | ✓        | ✗           | [CUE PAD 2]    | Hotcue 2 Button   |
| 24-3   | ✓        | ✗           | [CUE PAD 3]    | Hotcue 3 Button   |
| 24-4   | ✓        | ✗           | [CUE PAD 4]    | Hotcue 4 Button   |
| 1      | ✗        | ✗           | [JOG WHEEL]    | Jog/Scratch loaded track  |
| 1      | ✓        | ✗           | [JOG WHEEL]    | Jog/Scratch loaded track using <i>DJCRM2.jogwheelShiftMulti</i> |
| 10     | ✗        | ✗           | [GAIN]         | Controls pregain  |
| 18/19  | ✗        | ✗           | [VOLUME FADER] | Controls volume   |
| 4      | ✗        | ✗           | [PITCH FADER]  | Controls rate (speed control)                                   |
| 12     | ✗        | ✗           | [KILL TREBLE]  | High frequencies kill   |
| 12     | ✗        | ✗           | [KILL MEDIUM]  | Middle frequencies kill   |
| 12     | ✗        | ✗           | [KILL BASS]    | Low frequencies kill  |
| 14     | ✗        | ✗           | [TREBLE]       | High frequencies control  |
| 14     | ✗        | ✗           | [MEDIUM]       | Middle frequencies control                                      |
| 14     | ✗        | ✗           | [BASS]         | Low frequencies control   |
| 14     | ✓        | ✗           | [BASS]         | Filter (QuickEffectRack) control                                |

### 17.1.41 Hercules DJControl AIR

This is one of the cheapest Hercules DJ controller from Hercules leisure DJ controllers brand. There are actually many versions of it:

- DJControl AIR (The one shown in picture above)
- DJControl AIR Street Edition (Limited Edition)
- DJControl AIR S Series
- DJControl AIR for iPad

This controller have built-in soundcard with mixer output (3.5mm jack) and headphones output (6.35mm jack).

The main fun and uncommon feature of this controller is its proximity sensor (IR) located above EQ potentiometers and between top horizontal vu-meter.

- [Manufacturer's product page](#)
- [Forum Thread](#)

Nuovo nella versione 1.11.

## Sound Hardware settings

- Sample rate: 44100 Hz
- Master Output: Channels 1 - 2
- Headphones Output: Channels 3 - 4

## Mapping Description

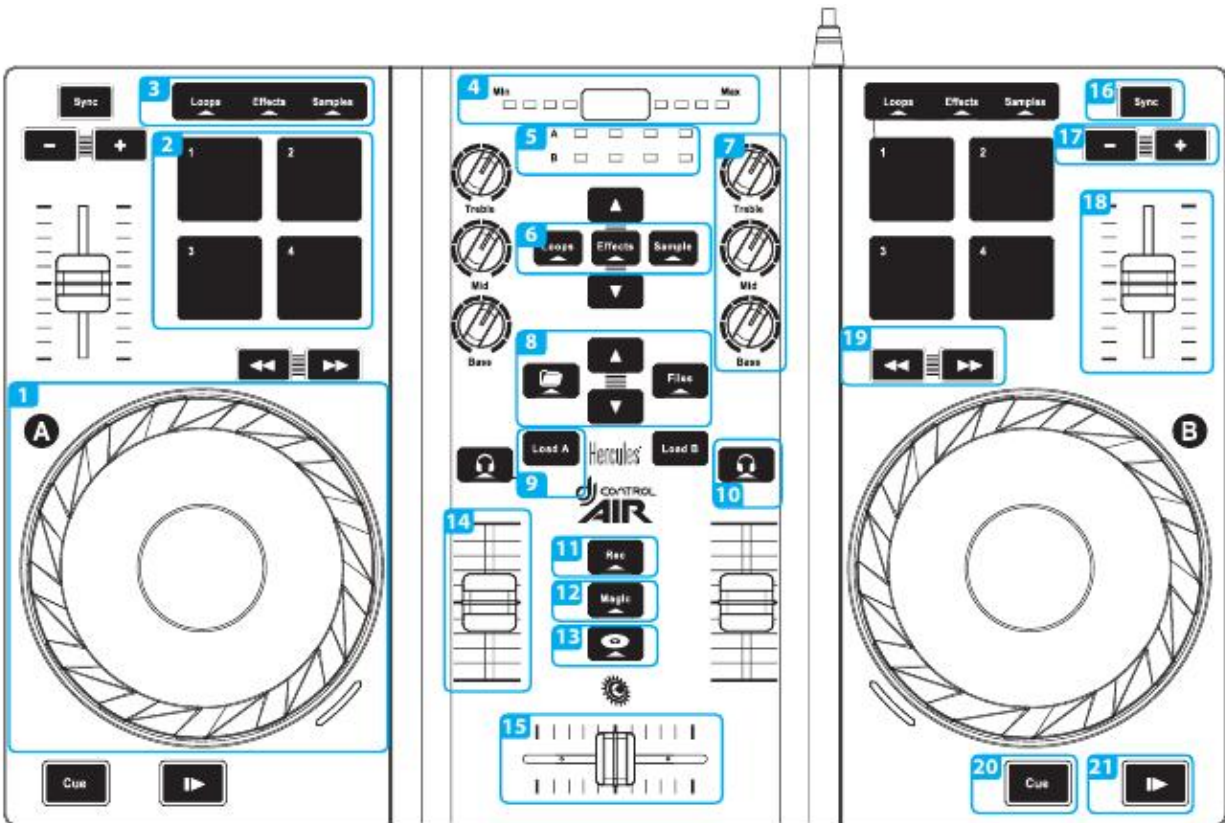

Figure19: Hercules DJControl AIR (schematic view). This picture is taken from the Getting Started Tutorial (courtesy of Guillemot Corporation S.A.).

We assume from the annotated picture above that each decks have same controls.

## Jogs / Jogs Wheels (1)

Pressing Jogs enable the scratch mode.

## PADs (2)

|   | Loops       | Effects                             | Samples  |
|---|-------------|-------------------------------------|----------|
| 1 | Loop In     | Flanger (Mixxx 1.10)                | Sample 1 |
| 2 | Loop Out    | Align Beat Grid to current position | Sample 2 |
| 3 | Loop Double | Toggle Quantitize                   | Sample 3 |
| 4 | Reloop/Exit | Toggle KeyLock                      | Sample 4 |

## Proximity Sensor (4)

*Currently not mapped*

## Library Navigation (8)

- **Folder** : Switch to previous view (library, playlist...)
- **Files** : Switch to next view (library, playlist...)
- **Up** : Scroll to previous track in library/playlist
- **Down** : Scroll to next track in library/playlist

## Load track to Deck (9)

This button load track to the selected deck (A => Deck 1, B => Deck 2)

## Headphone listen (PFL) (10)

This toggle the Pre Fader Listen for the selected Deck(s)

## Rec (11)

*Currently not mapped*

## Load selected track to sample (12)

This is done by pressing and holding the **Magic** button while pressing on the desired sample PAD.



## SpinBack(13)

*Currently not mapped*

## Sync (16)

Synchronize the tempo to the other deck one (One-time beat sync, tempo/phase).

## Speed Adjustment (17)

Adjust speed slower [ - ] or faster [ + ] in Coarse mode.

### 17.1.42 Hercules DJControl Compact

- [Manufacturer's product page](#)
- [MIDI mapping manual](#)

The Hercules DJControl Compact is a simple controller for basic two-channel mixing. This device does not have a built in sound card, so it would require a *splitter cable* or *separate audio interface* to be able to preview tracks in headphones. It also does not have buttons for routing decks to headphones.

Thanks to Hercules for supporting the development of this mapping by providing a controller.

Nuovo nella versione 2.1.

#### Mapping description

Much of the Compact's behavior is hard-coded into its firmware, including shift button messages and button mode selections.

Shift + Play jumps to the beginning of the track and stops playback.

The cue button behaves differently depending on the *cue mode set in Mixxx's Preferences*.

The sync button synchronizes the tempo to the other deck. Press and hold sync to engage *Sync Lock*.

There is only one each of the Mode, Shift, and Scratch buttons, so they affect both decks.

Shift + Scratch (Automix) toggles AutoDJ on/off.

#### Jog Wheels

When Scratch is off, turning a jog wheel bends the pitch of the track. When Scratch is on, turning a jog wheel scratches that deck. Holding Shift and turning a jog wheel adjusts the playback rate (tempo). Enable keylock on a deck by clicking the music note button on screen if you do not want the pitch to change when adjusting the tempo.

## Pad Grid

Press the MODE button to cycle through each pad mode.

### Loop mode

In loop mode, the buttons are mapped in a way that's more artistically expressive:

- Button 1 enables and disables the loop
- Button 2 enables an 8 beat loop
- Button 3 divides the current loop in half
- Button 4 doubles the length of the current loop
- Shift + Button 1 performs an 1/8th beat roll
- Shift + Button 2 performs an 1/4th beat roll
- Shift + Button 3 performs an 1/2th beat roll
- Shift + Button 4 performs an 1 beat roll

### FX mode

- Button 1 enables and disables the first FX chain for Channel 1
- Button 2 enables and disables the second FX chain for Channel 1
- Button 1 enables and disables the first FX chain for Channel 2
- Button 2 enables and disables the second FX chain for Channel 2

Shift-FX buttons are not mapped.

### Sampler mode

- Left side buttons play Sample Decks 1 through 4
- Right side buttons play Sample Decks 5 through 8
- Shift + Buttons stops Sample Deck and puts the playhead at the cue point

### Cue mode

- Each button activates the hotcue with that number
- Shift + button clears the hotcue with that number

### 17.1.43 Hercules DJControl Inpulse 200

- [Manufacturer's product page](#)
- [Manufacturer's support and downloads page](#)
- [Forum thread](#)

Nuovo nella versione 2.3.0.

#### Compatibility

This controller is a class compliant USB MIDI and audio device, so it can be used without any special drivers on GNU/Linux, Mac OS X, and Windows. However, if you wish to use the [ASIO sound API](#) under Windows, please install the latest driver package available from the [Support page](#).

#### Sound Card Setup

This controller has built-in 4 channel output sound card, with MASTER output (RCA) and HEADPHONE output (3.5mm jack).

1. Open *Preferences > Sound Hardware*
2. Select the *Output* tab
3. From the *Main* drop-down menu, select the audio interface, then *Channels 1 - 2*
4. From the *Headphones* drop-down menu, select the audio interface, then *Channels 3 - 4*
5. Click *Apply* to save the changes.

#### Vedi anche:

The [example setups section](#) provides more details about the audio configuration in Mixxx.

---

**Nota:** The MASTER and HEADPHONE knobs, as well as the MASTER button are hardware controls and interact directly with the integrated sound card's output. Although they also send MIDI messages, they have NOT been mapped in Mixxx, so do not expect an on-screen reaction when using them. This was done to prevent the knobs to adjust both the gain on the controller's sound card and in Mixxx.

---

#### Mapping description

All controls not mentioned behave as labeled.

## Decks

| Control                 | Function   |
|-------------------------|--|
| SYNC button             | Toggle <i>Sync Lock</i> .  |
| SHIFT + SYNC button     | Set deck as Sync leader.   |
| CUE button              | Specifies, plays or recalls temporary cue point.                     |
| SHIFT + CUE button      | Return to the beginning of the track.                                |
| Play button             | Play/Pause the current track.  |
| SHIFT + Play button     | Cue Stutter.   |
| VINYL button            | Toggle scratch mode (default: on)                                    |
| Loop IN button          | Enable Beatloop.   |
| SHIFT + Loop IN button  | Halve the current loop size.   |
| Loop OUT button         | Disable Beatloop.  |
| SHIFT + Loop OUT button | Double the current loop size.  |
| Beat Align LED          | Track end warning (make sure BEATMATCH GUIDE is on for this to work) |

## Browser

| Control                 | Function   |
|-------------------------|--|
| BROWSER encoder (turn)  | Move up/down list.   |
| BROWSER encoder (press) | Switch focus between list and file view.   |
| SHIFT + Encoder (press) | Maximize/Minimize library view.  |
| ASSISTANT button        | Toggle AutoDJ (be sure a playlist was created for AutoDJ before activating this function). |

## Performance Pads

### Hot Cue Mode

| Control           | Function                            |
|-------------------|-------------------------------------|
| Pad 1 - 4         | Set and trigger <i>hotcue</i> 1 - 4 |
| SHIFT + Pad 1 - 4 | Delete <i>hotcue</i> 1 - 4.         |

### Roll Mode

| Control | Function                     |
|---------|------------------------------|
| Pad 1   | Set Beatloop of 1 beat size. |
| Pad 2   | Set Beatloop of 2 beat size. |
| Pad 3   | Set Beatloop of 4 beat size. |
| Pad 4   | Set Beatloop of 8 beat size. |

## FX Mode

When using **Firmware v1.68 and earlier**, each FX pad will send multiple and different Note and CC messages. As these could not all be used properly with Mixxx current effect framework, a simplified configuration was assigned using the pad in SHIFT mode for convenience.

| Control                | Function              |
|------------------------|-----------------------|
| SHIFT + Pad 1 - 3      | Toggle Effect 1 - 3.  |
| SHIFT + Pad 4 (deck A) | Toggle Effect Rack 1. |
| SHIFT + Pad 4 (deck B) | Toggle Effect Rack 2. |

However, after applying **Firmware v1.72**, each FX pad now sends a simple Note On/Note Off (as is the case in every other Pad mode). This makes it easier to use the pads to control effect and the latest mapping take advantage of this possibility by removing the use of the SHIFT button.

| Control        | Function              |
|----------------|-----------------------|
| Pad 1 - 3      | Toggle Effect 1 - 3.  |
| Pad 4 (deck A) | Toggle Effect Rack 1. |
| Pad 4 (deck B) | Toggle Effect Rack 2. |

### Vedi anche:

Read the update guide for more details about [updating the firmware](#).

## Sampler Mode

| Control            | Function               |
|--------------------|------------------------|
| Pad 1 - 4 (deck A) | Trigger Sampler 1 - 4. |
| Pad 1 - 4 (deck B) | Trigger Sampler 5 - 8. |

## Unmapped Controls

The following controls are not mapped because they are controlled by the hardware.

- MASTER knob
- HEADPHONE knob
- MASTER buttons
- BEATMATCH guide

### 17.1.44 Hercules DJControl Inpulse 300

- [Manufacturer's product page](#)
- [Manufacturer's support and downloads page](#)
- [Forum thread](#)

Nuovo nella versione 2.2.4.

#### Compatibility

This controller is a class compliant USB MIDI and audio device, so it can be used without any special drivers on GNU/Linux, Mac OS X, and Windows. However, if you wish to use the *ASIO sound API* under Windows, please install the latest driver package available from the [Support page](#).

---

**Nota:** Firmware upgrade (v1.72) is required for pads to work correctly in **FX Mode**.

When using **Firmware v1.68** and earlier, pads in FX Mode will not work as expected.

For more details about [upgrading the Firmware](#).

---

#### Sound card setup

This controller has built-in 4 channel output sound card, with MASTER output (RCA) and HEADPHONE output (3.5mm jack).

- Open **Preferences > Sound Hardware**
- Select the **Output** tab
- From the **Master** drop-down menu, select the audio interface, then **Channels 1-2**
- From the **Headphones** drop-down menu, select the audio interface, then **Channels 3-4**
- Click **Apply** to save the changes.

#### Vedi anche:

The [example setups section](#) provides more details about the audio configuration in Mixxx.

---

**Nota:** The **Master** and **Headphone** knobs, as well as the **Master** button are hardware controls and interact directly with the integrated sound card's output. Although they also send MIDI messages, they have NOT been mapped in Mixxx, so do not expect an on-screen reaction when using them. This was done to prevent the knobs to adjust both the gain on the controller's sound card and in Mixxx.

---

## Mapping description

### Decks

| Control                 | Function   |
|-------------------------|--|
| SYNC button             | Toggle <i>Sync Lock</i> .  |
| SHIFT + SYNC button     | Set deck as Sync leader.   |
| CUE button              | Specifies, plays or recalls temporary cue point.                           |
| SHIFT + CUE button      | Return to the beginning of the track.                                      |
| Play button             | Play/Pause the current track.  |
| SHIFT + Play button     | Cue Stutter.   |
| VINYL button            | Toggle scratch mode (default: on)  |
| Loop IN button          | Enable Beatloop 4 beats.   |
| SHIFT + Loop IN button  | Halve the current loop size.   |
| Loop OUT button         | Disable Beatloop.  |
| SHIFT + Loop OUT button | Double the current loop size.  |
| Beat Align LED          | Track end warning (make sure BEATMATCH GUIDE is on for this to work).      |
| SLIP                    | Toggles slip mode.   |
| Q                       | Toggles quantize.  |
| SHIFT + Q               | Adjusts beatgrid so closest beat is aligned with the current playposition. |

### Browser

| Control                        | Function   |
|--------------------------------|--|
| BROWSER encoder (turn)         | Move up/down list.   |
| SHIFT + BROWSER encoder (turn) | Move left/right (fold/unfold) list.  |
| BROWSER encoder (press)        | Switch focus between list and file view.   |
| SHIFT + Encoder (press)        | Maximize/Minimize library view.  |
| ASSISTANT button               | Toggle AutoDJ (be sure a playlist was created for AutoDJ before activating this function). |

### FX

| Control                 | Function  |
|-------------------------|---|
| ON pad                  | Toggle FX 3 on/off.   |
| SHIFT + ON pad (select) | Cycle to the next effect after the currently loaded effect. |

## Performance Pads

### Hot Cue Mode

| Control           | Function                            |
|-------------------|-------------------------------------|
| Pad 1 - 8         | Set and trigger <i>hotcue</i> 1 - 8 |
| SHIFT + Pad 1 - 8 | Delete <i>hotcue</i> 1 - 8.         |

### Roll Mode

| Control | Function                            |
|---------|-------------------------------------|
| Pad 1   | Activate Beatloop of 1/8 beat size. |
| Pad 2   | Activate Beatloop of 1/4 beat size. |
| Pad 3   | Activate Beatloop of 1/2 beat size. |
| Pad 4   | Activate Beatloop of 1 beat size.   |
| Pad 5   | Activate Beatloop of 2 beat size.   |
| Pad 6   | Activate Beatloop of 4 beat size.   |
| Pad 7   | Activate Beatloop of 8 beat size.   |
| Pad 8   | Activate Beatloop of 16 beat size.  |

### FX Mode

| Control           | Function  |
|-------------------|---|
| Pad 1 - 3         | Toggle Effect 1 - 3.  |
| Pad 5 - 7         | Cycle to the next effect for Effect 1 - 3.                                    |
| Pad 4             | Toggle Effect Unit 1.   |
| Pad 8             | Toggle Effect Unit 2.   |
| Shift + Pad 1 - 3 | Toggle Effect 1 - 3. (Effect Unit 3 / 4 for deck A / B)                       |
| Shift + Pad 5 - 7 | Cycle to the next effect for Effect 1 - 3 (Effect Unit 3 / 4 for deck A / B). |
| Shift + Pad 4     | Toggle Effect Unit 3.   |
| Shift + Pad 8     | Toggle Effect Unit 4.   |

### Sampler Mode

| Control            | Function                |
|--------------------|-------------------------|
| Pad 1 - 8 (deck A) | Trigger Sampler 1 - 8.  |
| Pad 1 - 8 (deck B) | Trigger Sampler 9 - 16. |



## Beatjump Mode

| Control   | Function                          |
|-----------|-----------------------------------|
| Pad 1 - 2 | Jump backward/forward by 1 beat.  |
| Pad 3 - 4 | Jump backward/forward by 2 beats. |
| Pad 5 - 6 | Jump backward/forward by 4 beats. |
| Pad 7 - 8 | Jump backward/forward by 8 beats. |

## Known issues

### Controls not included in this mapping

- Master knob (Hardware control)
- Headphone knob (Hardware control)
- Master buttons (Hardware control)
- Beatmatch guide (Hardware control)
- PADS: Slicer/Slicer Loop
- PADS: Toneplay

### 17.1.45 Hercules DJControl Instinct (S)

This is the cheapest all-in-one controller with an integrated sound card. The DJControl Instinct S is functionally identical to the DJ Control Instinct, but has a brushed stainless finish.

- [Manufacturer's product page](#)
- [Forum thread](#)

Nuovo nella versione 1.10.1.

### Setup

The controller is a class compliant MIDI controller, so you should be able to just plug it in and it should be recognized in Mixxx. No need for drivers.

Make sure to select the correct mapping for the controller and enable it.

### Audio Channels

There are two outputs on the controller itself: the headphones output with builtin volume control on the side facing you and the speakers output.

In Mixxx the headphones output is on channels 3 and 4, so select the "Channels 3-4" item to get stereo output. The speakers output is on channels 1 and 2, so to get stereo output you want to select the "Channels 1-2" item.

Controls

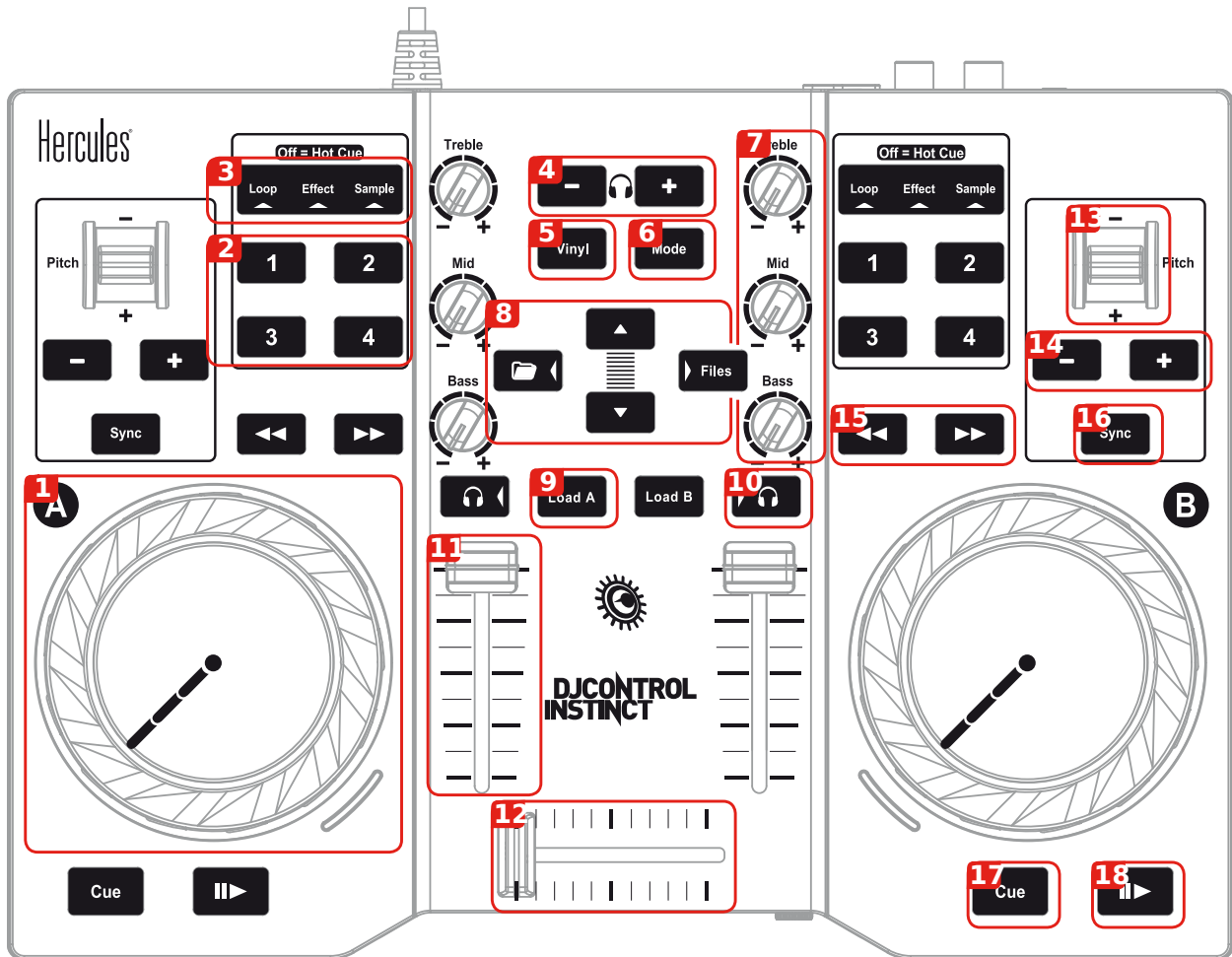

Figure20: Hercules DJControl Instinct (schematic view). This picture is taken from [product poster](#) (courtesy of Guillemot Corporation S.A.).

1. Jog Wheel for the deck on the side of the wheel
2. Action buttons for the deck on the side of the controls, depending on the mode they do the following:
  - Hot Cue:
    - 1: Set and play (by holding it) from Hot Cue 1
    - 2: Set and play (by holding it) from Hot Cue 2
    - 3: Reset Hot Cue 1
    - 4: Reset Hot Cue 2
  - Loop
    - 1: Set Loop start
    - 2: Set loop end
    - 3: Shrink loop (halves it)
    - 4: Exit loop

- Effect
    - **1:** Toggle Effect 1
    - **2:** Toggle Effect 2
    - **3:** Toggle Effect 3
    - **4:** Toggle Effect 4
  - Sample
    - **1:** Play Sample 1
    - **2:** Play Sample 2
    - **3:** Play Sample 3
    - **4:** Play Sample 4
3. Mode status display. The current mode is glowing or if none is on, Hot Cues are enabled.
  4. Headphone volume controls
  5. No direct use, used as a button to add a second layer of controls
  6. Switch the current mode for both decks
  7. Knobs to adjust the EQ of the deck they are on. Top knob adjusts highs, middle knob the mids and bottom knob the lows.
  8. Buttons to browse your library. The up and down button go up and down in the current playlist, The folder/left button goes up in the playlist list and the Files/right button goes down in the playlist list.
  9. Load the currently selected track to the respective deck (A is the left deck, B is the right deck)
  10. Listen to this deck unmixed on the headphones
  11. Deck volume adjusts the output volume of the respective deck
  12. Crossfader
  13. Temporary pitch shift. Pressing the Vinyl button increases the shift.
  14. Adjust tempo. Pressing both buttons together resets to the original tempo. Pressing the Vinyl button takes the steps bigger.
  15. Fast forward and backward buttons for the respective decks
  16. Sync tempo of this deck to the tempo of the other deck
  17. If pressed while paused sets the cue and when held plays from the cue, when pressed during playback jumps to the cue.
  18. Play and pause playback of the respective decks

## 17.1.46 Hercules DJControl Jogvision

- [Manufacturer’s product page](#)
- [Manufacturer’s support and downloads page](#)
- [Forum thread](#)

Whether you’re just getting started DJing or you’ve already refined your skills, you can let your creativity run wild. Enjoy excellent precision and comfort to create your mixes using the circular displays on the jog wheels to guide your movements and perfect your scratches, and have fun with the amazing contactless AIR Control sensor. Your adventure starts right here and now. It’s your turn!

### Compatibility

This controller is a class compliant USB MIDI and audio device, so it can be used without any special drivers on GNU/Linux, Mac OS X, and Windows. For Windows, please install the latest driver package available from the manufacturer’s product page.

### Sound card setup

This controller has built-in 4 channel output sound card, with:

| Channel          | Port                  |
|------------------|-----------------------|
| Master Output    | RCA and 3.5mm jack    |
| Booth Output     | RCA and 3.5mm jack    |
| Headphone Output | 6.35mm and 3.5mm jack |
| Microphone Input | 6.35mm jack           |
| Auxiliary Input  | 3.5mm jack            |

- Open *Preferences* ▶ *Sound Hardware*
- Select the *Output* tab
- From the *Master* drop-down menu, select the audio interface, then *Channels 1-2*
- From the *Headphones* drop-down menu, select the audio interface, then *Channels 3-4*
- Click *Apply* to save the changes.

Please refer to the user manual for more details about the audio configuration in Mixxx.

---

**Nota:** The MASTER and HEADPHONE knobs, as well as the MASTER button are hardware controls and interact directly with the integrated sound card’s output.

---

## Mapping configuration

Edit the `Hercules_DJControl_Jogvision-scripts.js`, and change the `CFG.(user|fine)` variables to fit your needs:

---

**Suggerimento:** This controller mapping can be customized by editing the corresponding Javascript file and editing the configuration options at the top of the file.

---

All controls act as labeled, but there are some additional functionalities that have been added:

| Control                          | Description  |
|----------------------------------|--|
| MODE + LOOP ON                   | Set a loop_in mark (with currently defined loop_size), activate it, and enable slip mode |
| MODE + LOOP X½ / LOOP X2         | Do a beatjump backward/forward   |
| MODE + LOOP SIZE knob            | Decrease/Increase pitch (only key, not tempo!)   |
| MODE + Jog Wheel plate (playing) | Scratch with “Slip” on (deactivate “Slip” when plate is released)                        |
| MODE + Jog Wheel plate (stopped) | Move song position backward/forward faster   |
| MODE + BROWSER knob turn         | Move library’s selected position multiple elements forward/backward                      |
| MODE + LOAD buttons              | Toggle “quantize” for deck where MODE button is pressed                                  |
| SHIFT + LOAD buttons             | Eject track from deck where SHIFT key is pressed   |
| SHIFT + BROWSER knob press       | Activate (double-click) currently selected item in browser                               |
| SHIFT + LOOP SIZE knob           | Move existing loop forward/backward  |
| SHIFT + Jog Wheel touch          | Do a backspin  |
| SHIFT + MULTI FX                 | Set beatgrid to current position   |
| SHIFT + AIR CONTROL Filter       | Do the reverse than standard, that is, high-pass filter                                  |

### 17.1.47 Hercules DJControl MP3

Nuovo nella versione 1.11.

---

**Nota:** Unfortunately a detailed description of this controller mapping is still missing. If you own this controller, please consider [contributing one](#).

---

### 17.1.48 Hercules DJControl MP3 e2 / MP3 LE / Glow

The Hercules DJ Control MP3 e2, MP3 LE, and Glow are USB controllers that have identical controls and share the same mapping. These controllers do not have a built in sound card, so a *splitter cable* or *separate audio interface* is recommended for use with it.

Nuovo nella versione 1.11.

Cambiato nella versione 2.3.0.

This new version is intended to work in a more intuitive way. Once you click on a button, it does its original function.

**Nota:** These controllers are not class compliant *MIDI* devices. On Linux, older versions of Mixxx required using a custom Hercules kernel module. This is neither necessary nor recommended anymore.

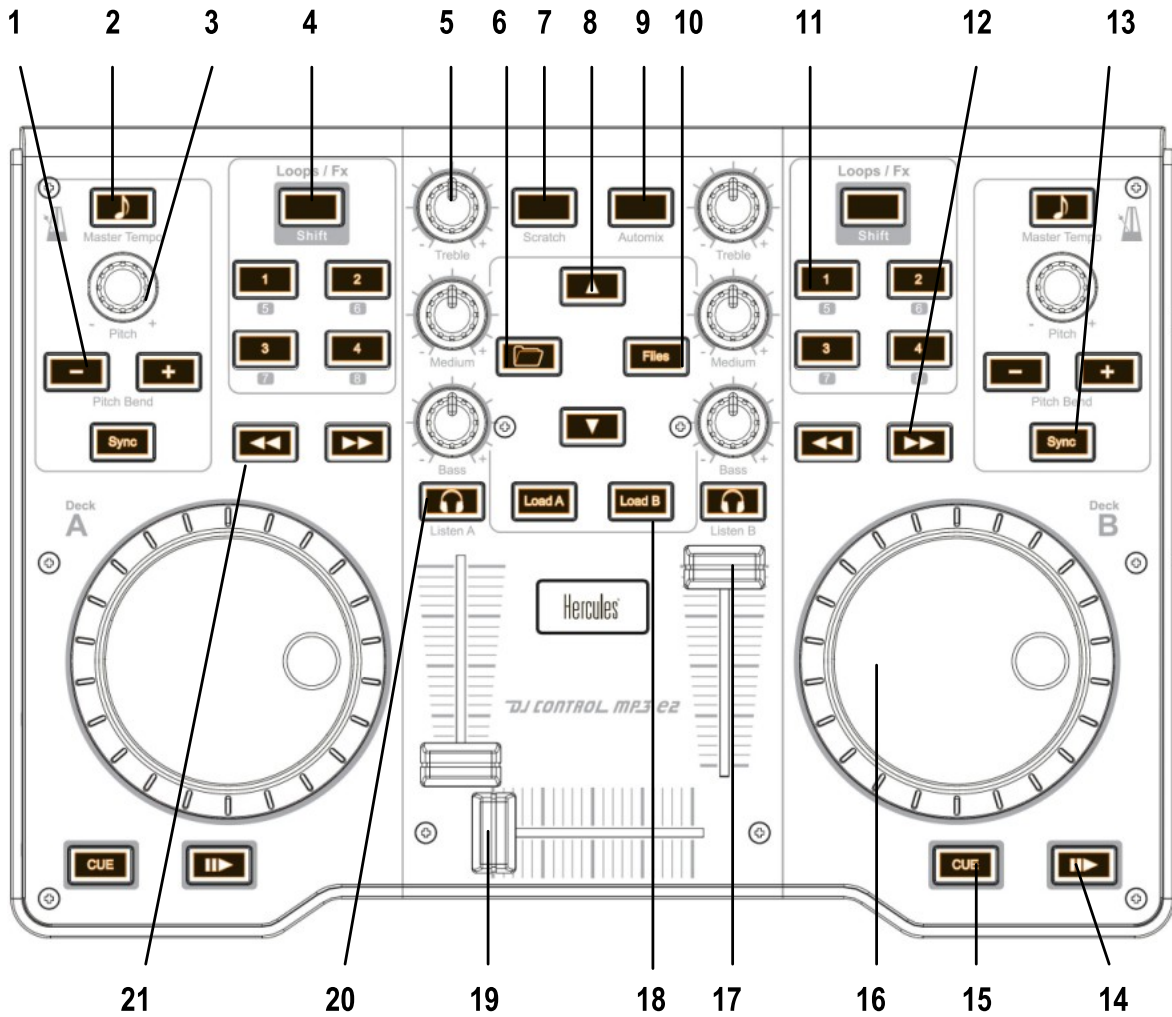

Figure21: Hercules DJControl MP3 e2 (schematic view)

## Mapping description (by function)

### Library

| Number | Control       | Function   |
|--------|---------------|--|
| 6      | Folder        | Toggle playlist selection  |
| 10     | Files         | Toggle track selection   |
| 8      | Up arrow      | Go one playlist/track up   |
| 8      | Down arrow    | Go one playlist/track down   |
| 18     | Load A/Load B | Loads the currently highlighted track into the corresponding deck (A or B) |

### Master/Headphones

| Number | Control           | Function  |
|--------|-------------------|---|
| 19     | Crossfader        | Fades between left (channel 1) and right (channel 2) deck |
| 20     | Headphone monitor | Toggles deck output to the headphones monitor on/off      |

### Decks / Channels

#### Playing

| Number | Control            | Function  |
|--------|--------------------|---|
| 18     | Load A/Load B      | Loads the currently highlighted track into the corresponding deck (A or B)  |
| 14     | Play               | Starts or stop a loaded track   |
| 15     | Cue                | Sets the cue point if a track is stopped and not at the current cue point. Stops track and returns to the current cue point if a track is playing. Plays preview if a track is stopped at the cue point for as long as it's held down |
| 12     | Forward / Backward | Move Forward/Backward in track  |
| 7      | Scratch            | Enable or disable the scratch mode on all two decks   |
| 16     | Jog wheel          | Seeks forwards and backwards in a stopped track. Temporarily changes the playback speed for playing tracks. Absolute sync of the track speed to the jog wheel if scratch mode enabled   |

### Volume / Equalizer / Effects

| Number | Control            | Function  |
|--------|--------------------|---|
| 17     | Deck volume slider | Controls the deck output volume, with soft takeover on deck switch.         |
| 5      | Equalizer knobs    | Adjusts the gain of the low/medium/high equalizer filter. No soft takeover. |
| 4      | Shift              | Toggle Effects Selection  |
| 11     | Button 1/2/3       | Toggle Effect 1/2/3 for corresponding deck (with shift activated)           |

## Loops

| Number | Control  | Function |
|--------|----------|----------|
| 11     | Button 1 | Loop 1   |
| 11     | Button 2 | Loop 2   |
| 11     | Button 3 | Loop 4   |
| 11     | Button 4 | Loop 8   |

## Pitch / Syncing

| Number | Control       | Function   |
|--------|---------------|--|
| 1      | Pitchbend +/- | Temporary Holds the pitch 4% lower or higher while pressed       |
| 3      | Pitch knobs   | Adjust playback pitch / speed                                    |
| 13     | Sync          | Automatically sets pitch so the BPM of the other deck is matched |
| 2      | Master Tempo  | Enable and lock Sync Mode  |

## Troubleshooting

### Jog wheels not working or controller not responding

If your jog wheels doesn't work, or nothing works on the controller even when you have carefully read all other resources, you should be aware that this controller stores at least two configuration options in the controller:

- Enable/disable Jog Wheels
- MIDI channel to use

and maybe a third one: Jog wheel sensitivity

With factory default settings, the jog wheels are enabled and the MIDI channel used is channel 1. The mapping is made for channel 1 only. If your controller is configured for another channel, nothing will work and if you launch Mixxx with `-`-controllerDebug`` parameter, you will have lines like this one showing in the logs when you press a button on the controller :

```
Debug [Controller]: "DJ Control MP3 e2 : 3 bytes: B3 38 38 "
```

note the B3 here. it's B<MIDI Channel # - 1>. So this controller is configured on channel 4. controller configured on channel 1 will show B0, which is correct.

To change these parameters, you have to use the configuration tool that comes with the Hercules driver on on [the Hercules support page](#). Unfortunately, the configuration tool is only available for Windows and Mac OS X. We are not aware of any solution for Linux. So if you normally use Linux, you will have to find a computer with Windows or Mac OS X, install the Hercules driver, plug-in the controller and change configuration. You will only need to do this once, then the controller should work with Linux.



## Controller not recognized as bulk controller

It has been reported that when the Hercules drivers are installed on a Windows, the driver takes over the bulk communication with the controller so it cannot be recognized by Mixxx as a bulk controller. Uninstall the Hercules driver and use it as a USB bulk controller.

### 17.1.49 Hercules DJControl Starlight

Ultra-compact, ultra-light, ultra-practical and ultra-unique with its lights, the DJControl Starlight packs all the features needed to mix and scratch. With its built-in audio interface, the DJControl Starlight offers pre-listening in the headphones so you can then play your mix on speakers, which is perfect for learning or creating new mixes. The system is so comprehensive for its size that it boasts all the essential features such as bass equalization/filter knobs for smooth transitions or touch-sensitive jog wheels for easy scratching. The added bonus: the bright and powerful RGB backlighting.

- [Manufacturer's product page](#)
- [Manufacturer's support and downloads page](#)
- [Forum thread](#)

Nuovo nella versione 2.3.

## Compatibility

This controller is a class compliant USB *MIDI* and audio device, so it can be used without any special drivers on GNU/Linux, macOS, and Windows. However, if you wish to use the ASIO sound *API* under Windows, please install the latest driver package available from the [Support page](#).

## Sound card setup

This controller has built-in 4 channel output sound card, with master and headphone output (both 3.5mm jack).

- Open **Preferences > Sound Hardware**
- Select the **Output** tab
- From the **Master** drop-down menu, select the audio interface, then **Channels 1-2**
- From the **Headphones** drop-down menu, select the audio interface, then **Channels 3-4**
- Click **Apply** to save the changes.

### Vedi anche:

More details about audio configuration can be found in the [here](#).

---

**Nota:** The **Master** and **Headphone** knobs are hardware controls and interact directly with the integrated sound card's output. Although they also send *MIDI* messages, they have NOT been mapped in Mixxx, so do not expect an on-screen reaction when using them. This was done to prevent the knobs to adjust both the gain on the controller's sound card and in Mixxx.

The *gain staging section of this manual* explains how to set your levels properly when using Mixxx.

---

## Mapping description

The base LED is linked to the VU Meter for light show effect on each deck respectively.

All controls not listed here work as labeled.

## Decks

| Button       | Description                        |
|--------------|------------------------------------|
| SYNC         | Sync lock                          |
| SHIFT + SYNC | Set deck as sync leader            |
| CUE          | Cue point                          |
| SHIFT + CUE  | Return to beginning of loaded song |
| PLAY         | Play/Pause                         |
| SHIFT + PLAY | Cue Stutter                        |
| VINYL        | Scratch On/Off (Default: on)       |

When Vinyl is on, turning a jog wheel scratches that deck. When Vinyl is off, turning a jog wheel bends the pitch of the track.

## Pads

| Pad Mode | Button            | Description                                |
|----------|-------------------|--|
| Hot Cue  | Pads 1-4          | Set and trigger Hot Cue 1-4                |
| Hot Cue  | SHIFT + Pads 1-4  | Pad = Delete Hot Cue 1-4.                  |
| Loop     | Pad 1             | Beatloop 1/2 beat                          |
| Loop     | Pad 2             | Beatloop 1 beat                            |
| Loop     | Pad 3             | Beatloop 2 beats                           |
| Loop     | Pad 4             | Beatloop 4 beats                           |
| FX       | Pads 1-3          | FX 1-3 on/off                              |
| FX       | SHIFT + Pads 1-3  | FX 1-3 select                              |
| FX       | Pad 4             | FX Rack 1/2 On/Off (Deck A/B respectively) |
| Sampler  | Pads 1-4 (Deck A) | Sampler 1-4                                |
| Sampler  | Pads 1-4 (Deck B) | Sampler 5-8                                |

### 17.1.50 Hercules P32 DJ

- [Manufacturer's product page](#)
- [Manufacturer's technical support page](#)
- [Forum thread](#)

The Hercules P32 DJ is a relatively compact DJ controller with a built-in sound card. Rather than jog wheels, it has a 4 x 4 multicolor (red/blue/purple) pad grid for each deck. The pad grids can be switched between 4 different layers to perform a variety of functions.

Thanks to Hercules for supporting the development of this mapping by providing a controller.

Nuovo nella versione 2.1.

Cambiato nella versione 2.3.0: Add pitch controls in loop mode and increased head mix knob precision.



Figure22: [https://www.hercules.com/wp-content/uploads/2018/05/HerculesDJ\\_HerculesP32DJ\\_top-1400x747.jpg](https://www.hercules.com/wp-content/uploads/2018/05/HerculesDJ_HerculesP32DJ_top-1400x747.jpg)

## Compatibility

This controller is a class compliant USB MIDI and audio device, so it can be used without any special drivers on GNU/Linux, Mac OS X, and Windows. However, it is recommended to install [the driver](#) on Windows to be able to use the *ASIO sound API*.

## Sound card setup

This device has a built-in 4 channel output sound card. There are 2 RCA outputs for the main output and a 1/4" TRS stereo headphone jack. There are buttons in the center of the controller that adjust the sound card's headphone output volume in hardware. These do not adjust the headphone gain in Mixxx.

**Avvertimento:** There is no master output volume control on the device, but the master output volume of the sound card can be controlled from the OS mixer. The device comes with the main output set to 45%. So, for the best *gain staging*, turn the volume of the main output all the way up in your operating system mixer.

## Mapping description

### User configurable options

There are a few user configurable options available for you to customize. You can change these by opening the `Hercules-P32-scripts.js` file with your text editor of choice (such as Notepad, TextEdit, Kate, or gEdit) and editing the lines at the very top of the file.

- **loopEnabledDot:** whether to use the dot on the loop size LED display to indicate that a loop is active. This restricts loop sizes to 2-32 beats and may be helpful if you never use loops less than 2 beats long. Otherwise the dot indicates a loop size equal to 1/(# on the LED display).

- **samplerCrossfaderAssign**: whether to assign the samplers to the crossfader. If true, the samplers controlled by the left pad grid are assigned to the left of the crossfader and the samplers controlled by the right pad grid are assigned to the right of the crossfader.
- **toggleEffectUnitsWithDecks\***: whether to automatically toggle the effect unit controls between units 1 & 3 on the left and units 2 & 4 on the right when toggling decks between decks 1 & 3 and 2 & 4

## Encoders

The encoders do not behave exactly as labeled.

- **Browse encoder**: scrolls through library. Pushing toggles big library view. Turning with shift controls the cue/main mix going to the headphone output. Pushing with shift toggles split cue mode (left ear of headphone output plays cue signal, right ear plays main signal).

The mapping of the encoders does not match their labels. They are labeled on the controller symmetrically, but they are mapped asymmetrically like the rest of the deck controls:

- **Left encoder**: Turning halves/doubles the loop size. Turning with shift beatjumps by 1 beat forward/backward, or if a loop is enabled, moves the loop 1 beat forward/backward. Pushing (de)activates a loop. Pushing with shift reactivates a disabled loop, or if a loop is enabled, jumps to the loop in point and stops the deck.
- **Right encoder**: Turning adjusts the pitch, or with keylock on, just the tempo. Pushing resets the pitch to the track's default. Turning with shift jumps forward/backwards by the beatjump size. If a loop is enabled, turning with shift moves the loop by the beatjump size. Hold shift, push, and turn to adjust the beatjump size, shown on the LED display on the controller. When the encoder is released, the LED display goes back to showing the loop size.

## Effects

Refer to the [Standard Effects Mapping](#) page for details on how to use the effects sections.

When the pad grid is in Slicer mode, the pads in the top left of the grid assign the deck to Effect Units 1-4.

Pressing the headphone button with shift assigns the effect unit on that side to the headphone channel. This is useful for previewing an effect on a playing deck before using it. The headphone (PFL) button must also be pressed on the deck to hear the effect on it in headphones.

## Other controls

- **Record button**: toggles recording on and off.
- **Slip button**: toggles slip mode on and off for all decks. With shift, toggles between decks 1 & 3 on the left and decks 2 & 4 on the right.
- **Pad grid**: Press the Hotcue/Loop/Slicer/Sampler buttons to activate different modes
- **Hotcue mode**: Press an unlit pad to set a hotcue. Press a red pad to activate a hotcue. Press a red pad with shift to delete a hotcue.
- **Loop mode**: Control manual loops and other miscellaneous functions. On the top row, from left to right, the pads set the loop in point, loop out point, and toggle the loop (without changing its size). Hold the loop in or loop out button while moving the waveform with the mouse to adjust the loop in/out point (new in Mixxx 2.1). On the bottom row, the two purple buttons temporarily decrease/increase the playback speed while they are held down for beatmatching. The button to the right of those shifts the beat grid to the current position. The right column is for pitch management, from top to bottom: match the key with the other track, pitch up, pitch down, and reset to the default key of the track.

- **Slicer mode:** refer to Effects section above
- **Sampler mode:** Press an unlit pad to load the track selected in the library to that sampler. Pads are blue when the sampler is loaded but not playing and red when playing. Press a blue pad to play the sample from its cue point. Press a red pad to jump back to the sample’s cue point. Press a red pad with shift to stop a playing sample. Press a blue pad with shift to eject a sample. Note that samplers are independent from decks; the left grid controls samplers 1-16 and the right grid controls samplers 17-32.
- **Sync:** Short press to sync to other deck. Press and hold to enable master sync.
- **Shift + sync:** toggle quantize
- **Shift + cue:** jump to beginning of track and stop
- **Shift + play:** toggle reverse playback
- **Shift + load:** ejects a track from the deck
- **EQ knobs, volume faders, crossfader, headphone button, play, cue, sync, and load** all behave as labeled.

### 17.1.51 ION Discover DJ

The ION Discover DJ is a cheap budget MIDI controller meant to “discover DJ-ing” for people with a potential interest. It does not have a built in sound card, so a *splitter cable* or *separate audio interface* is required to use headphones with it.

- [Manufacturer’s product page](#)
- [Forum thread](#)

Nuovo nella versione 1.8.

#### Compatibility

This controller is USB MIDI class compliant, so it is plug-and-play on all platforms without having to install any special drivers. The manufacturer’s page only mentions Windows and Mac but it’s confirmed working on Linux as well.

#### Library browsing

The controls for library browsing are in the center of the controller.

| Control                | Function  |
|------------------------|---|
| Rotary encoder         | Track selection   |
| Load buttons           | Loads currently highlighted track to the corresponding deck (only if no audio is playing) |
| Pushing rotary encoder | Maximizes/minimizes the library   |

#### Jog wheels

The button in the center can be used to switch the jog wheels between search and scratch mode. In search mode, the jog wheels can be used to seek to different parts of a song when paused. When that deck is playing, the jog wheels can be pushed/pulled to speed up/slow down the playback. This is useful for beatmatching.

Pressing the center button will put the jog wheels in scratch mode, which means that the deck in Mixxx will follow the absolute movement of the jog wheels. In this mode the Scratch button is lit.

## Equalizers

This controller only has a 2-band equalizer but Mixxx uses a 3-band EQ. Therefore, the volume knob has been mapped to the low EQ, the bass knob has been mapped to the mid EQ, and the treble knob has been mapped to the high EQ. For controlling the volume of the decks, use the crossfader.

## Other buttons

The pitch buttons will control the tempo which also controls the pitch, except when keylock is on (padlock icon on screen).

| Button     | Function   | Light                            |
|------------|--|----------------------------------|
| Sync       | Matches the BPM of that deck to the song playing in the other deck | Blinks according to the beatgrid |
| Rev        | While held the deck plays in reverse                               | only lights when pressed         |
| CUE        | Attached to the cue control in mixxx                               | follows cue button on screen     |
| play/pause | Play/pause the deck  | follows play button on screen    |

The behavior of the cue and play buttons can be configured in *Mixxx's preferences <interface-cue-modes>*.

### 17.1.52 ION Discover DJ Pro

Ion Discover DJ Pro is a 2-deck controller with integrated audio interface and iPhone dock.

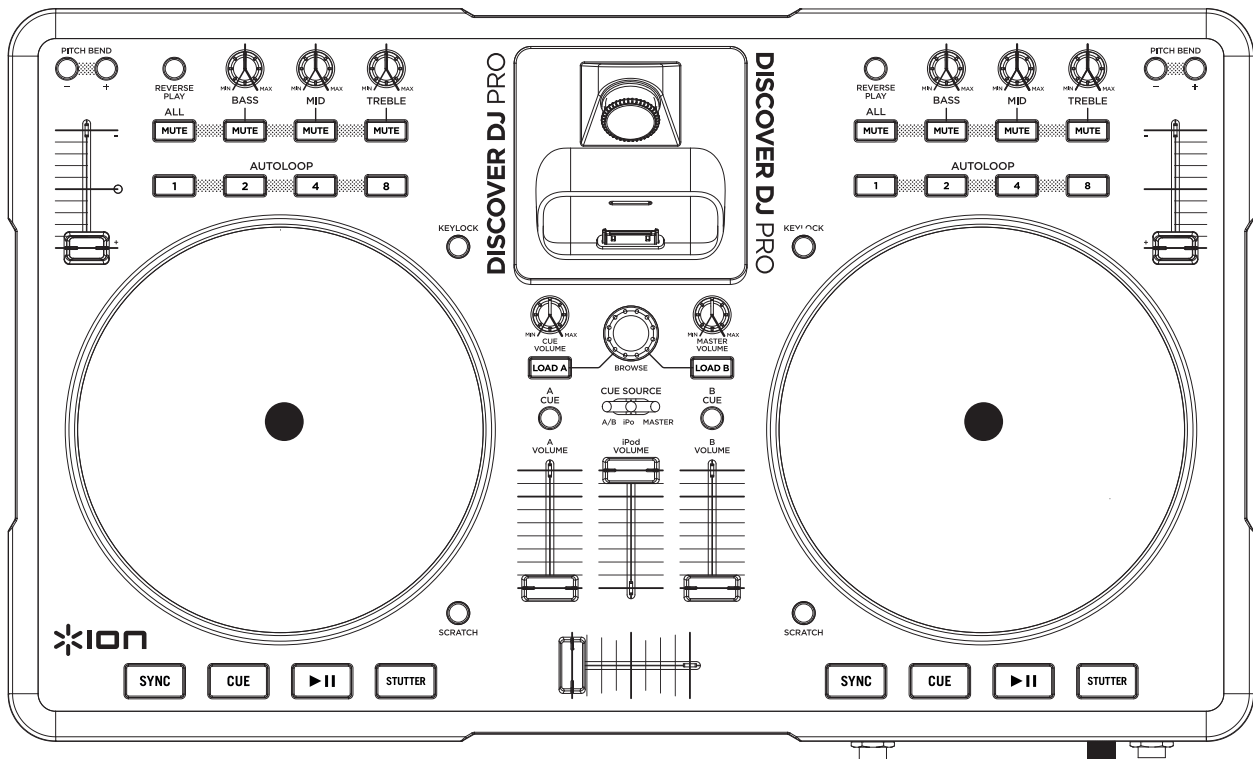

Figure23: ION Discover DJ Pro (schematic view)

- [Mixxx User Forum](#)

Nuovo nella versione 2.2.5.

## Compatibility

This controller is USB MIDI class compliant, so it is plug-and-play on all platforms without having to install any special drivers. The manufacturer's page only mentions Windows and Mac but it's confirmed working on Linux as well.

## Controller Mapping

### Deck section

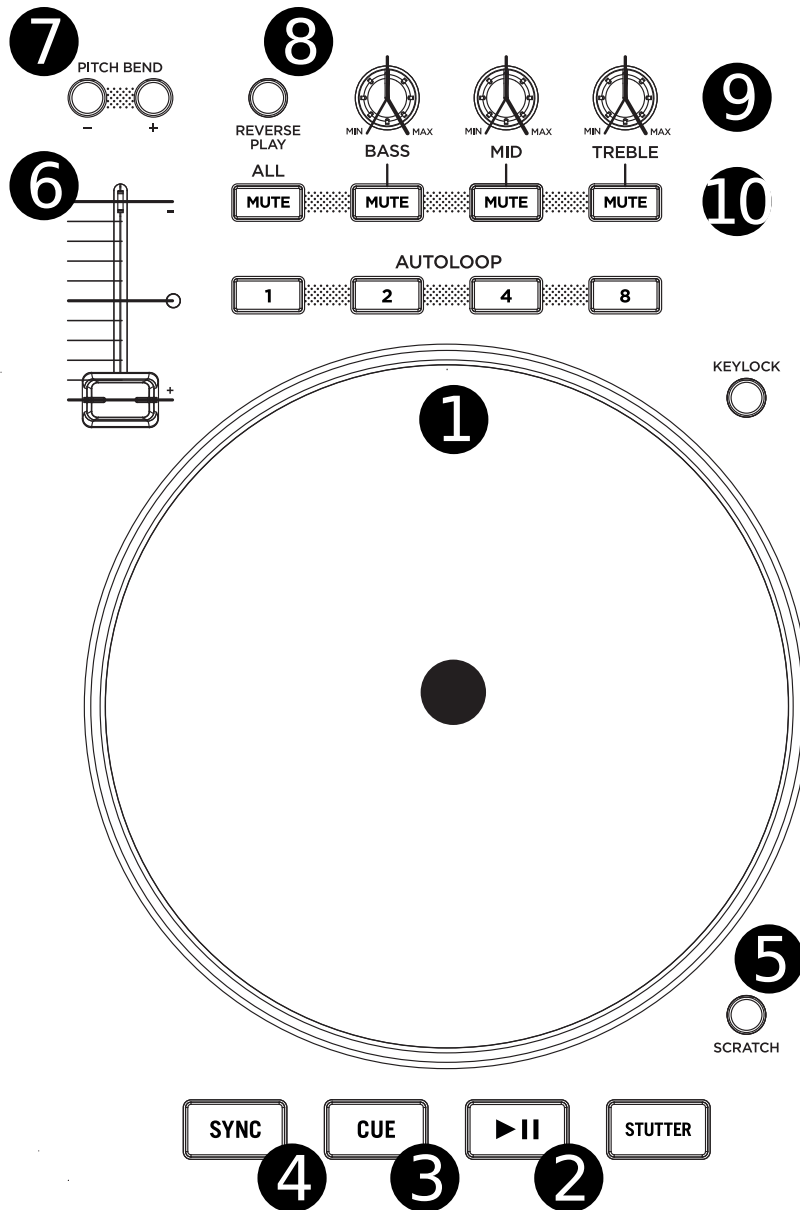

Figure24: ION Discover DJ Pro (deck section)

| No. | Control                | Function   |
|-----|------------------------|--|
| 1   | JOG WHEEL              | Scratches the track  |
| 2   | PLAY/PAUSE button      | Plays/pauses a track in the respective Deck                  |
| 3   | CUE button             | While playing: go to cue point, while stopped: set cue point |
| 4   | SYNC button            | Sync the tempo to other playing track                        |
| 5   | SCRATCH button         | Toggle the scratch mode                                      |
| 6   | TEMPO slider           | Adjust the track playing speed                               |
| 7   | PITCH BEND buttons +/- | Lower (-) or Raise (+) the pitch temporarily                 |
| 8   | REVERSE PLAY button    | Hold for reverse play  |
| 9   | BASS/MID/TREBLE knobs  | Adjust the low/mid/high-frequency regions of the song        |
| 10  | MUTE buttons           | Mute low/mid/high-frequency regions                          |

### Mixer section

| No. | Control                 | Function   |
|-----|-------------------------|--|
| 1   | Channel faders          | Adjust the output level for each channel                   |
| 2   | Cross fader             | Fades between left and right deck.                         |
| 3   | A CUE / B CUE buttons   | Sends the selected channel's audio to the headphone output |
| 4   | LOAD A / LOAD B buttons | Load the selected library track to deck A / B              |
| 5   | CUE VOLUME knob         | Control the output volume of the headphones output         |
| 6   | BROWSE knob             | Browse the library   |
| 7   | MASTER VOLUME knob      | Control the output volume of the master output             |

### Known Issues

Controls not yet working:

- STUTTER button
- ALL MUTE button
- AUTOLOOP buttons
- iPod dock

### 17.1.53 Keith McMillen QuNeo

- [Manufacturer's product page](#)

Keith McMillen QuNeo is a USB multi purpose pad controller and features tactile pads, sliders, rotary sensors and switches. Works with USB, MIDI or OSC and will communicate most music software environments right out of the box.

#### Features

- 27 pads, sliders and rotary sensors are pressure, velocity, and location sensitive. Even the 17 switches respond to how hard you press.
- LED Light Feedback - variably diffusive elastomers with 251 multi-color LEDs, 16 square pads provide 127 levels of Velocity response, X-Y location and continuous pressure.
- 2 rotary sensors allow you to scrub, trigger, stretch, pinch and play phrases and sound files, manipulate continuous controllers and more .



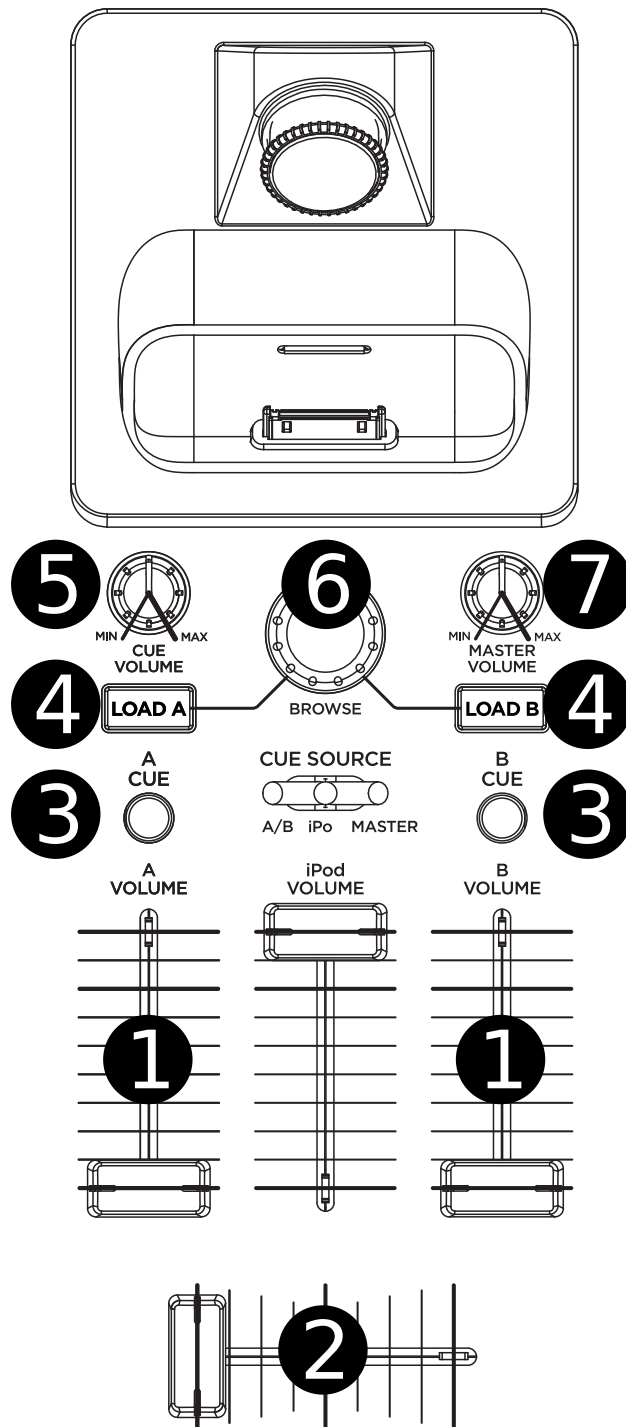

Figure25: ION Discover DJ Pro (mixer section)

- Each rotary sensor measures angle, pressure and distance from the center.
- 9 touch sensitive sliders can thomann be mapped to fader and effects controls.
- LEDs within each slider act as VU meters.
- QuNeo is the size of an iPad (V1) and can fit in iPad accessories such as mic clips, stands and more.
- Advanced users and programmers can use the development kit and API to create their own code to respond to QuNeo’s sensor data. Hack away to control your world in ways never before possible!

Nuovo nella versione 1.11.

### Mapping Description

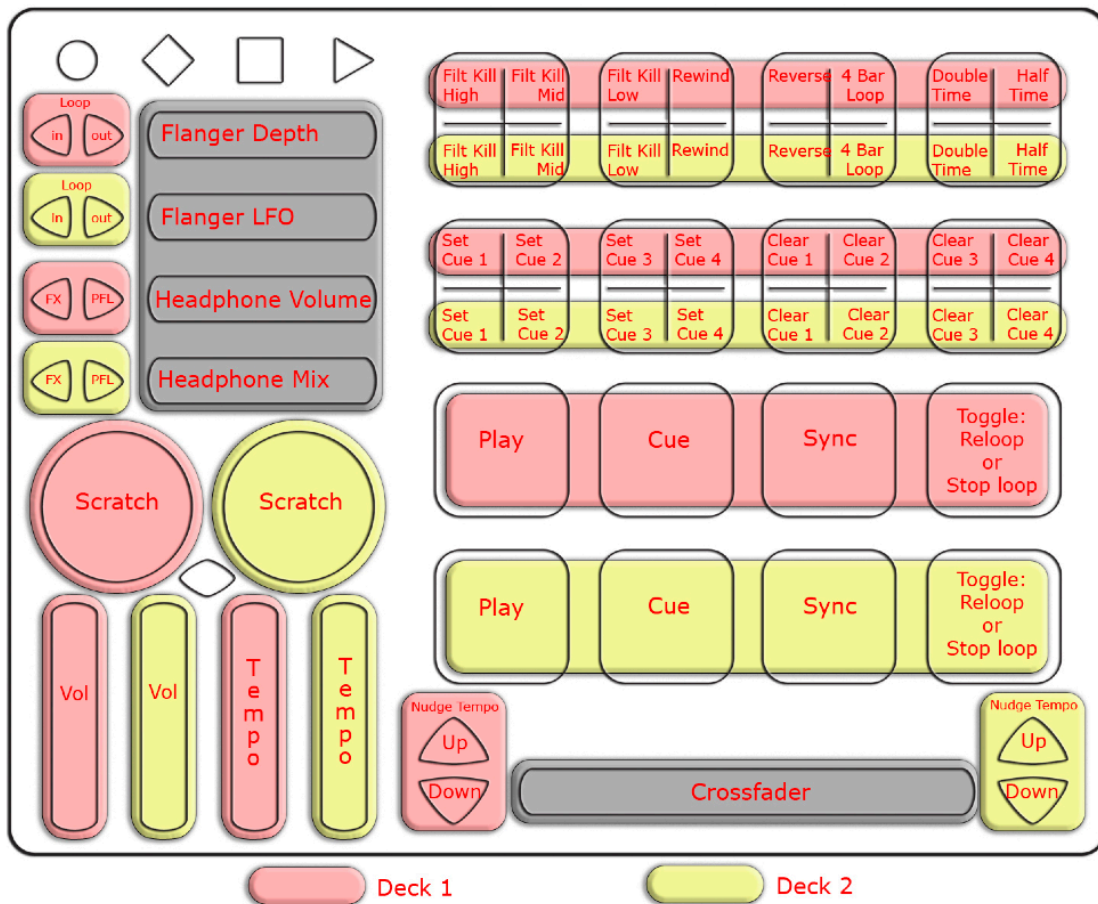

Figure26: Keith McMillen QuNeo (schematic view)

The mapping is included with the QuNeo installer, make sure to click the “Mixxx” check box when prompted during the installation. Alternatively download the Installer from [www.keithmcmillen.com](http://www.keithmcmillen.com). The MIDI mapping goes with QuNeo’s factory preset number 12. To change the factory preset, select the blue MODE button on the device and press tab #12. Also see [Youtube - Setting up Mixxx with QuNeo](#).

It turns QuNeo into a full fledged DJ controller using Mixxx. It includes controls for 2 players: play, sync, cue, tempo controls, crossfading, scratching, and various volume controls accessible from QuNeo.

### 17.1.54 Kontrol DJ KDJ500

- [Forum thread](#)

Nuovo nella versione 1.10.

**Nota:** Unfortunately a detailed description of this controller mapping is still missing. If you own this controller, please consider [contributing one](#).

### 17.1.55 Korg Kaoss DJ controller

2-deck controller with touch controlled jogwheels, built-in 4-channel soundcard and a Korg Kaoss Pad as built-in effect section (can be switched off for using software effects).

- [Manufacturer's product page](#)
- [Forum thread](#)
- [Pull request on Github](#)

Nuovo nella versione 2.1.

#### Mapping

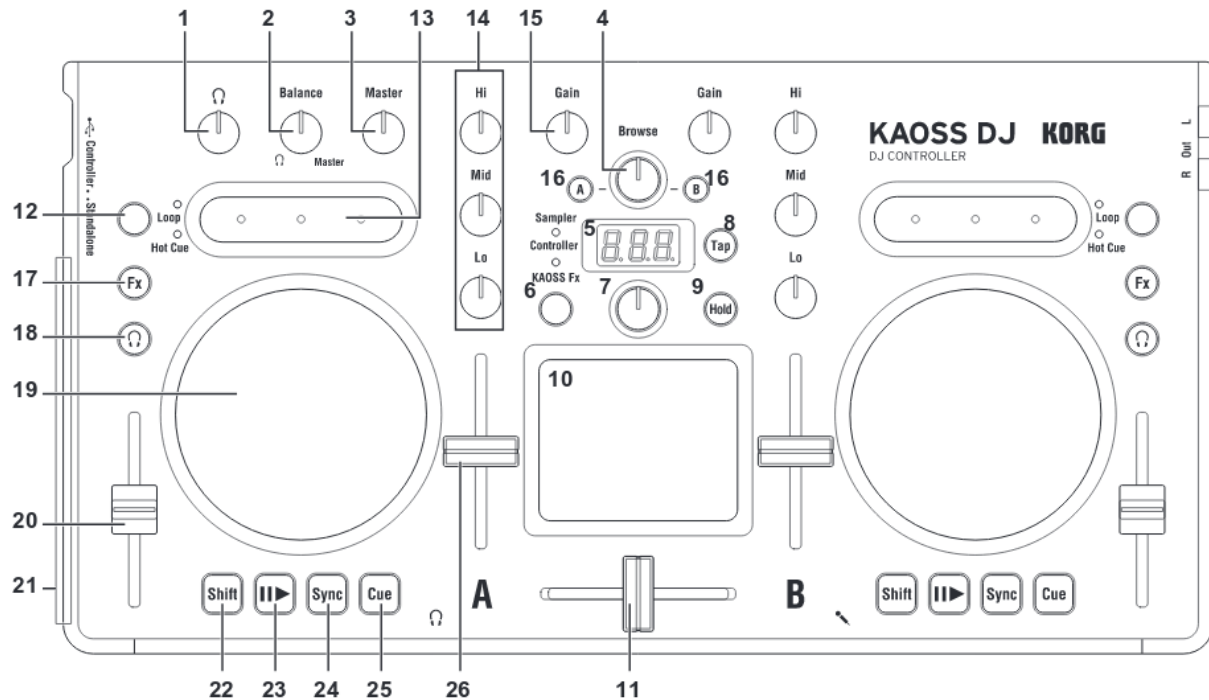

Figure27: Korg Kaoss DJ (schematic view)

| No. | Name                         | Function   |
|-----|------------------------------|--|
| 1   | Headphone knob               | Adjusts the headphone level  |
| 2   | Balance knob                 | Adjusts the balance between the master level and the headphone monitor level                       |
| 3   | Master knob                  | Adjust the master volume level   |
| 4   | Browse knob                  | Selects a song from the library  |
| 5   | Display                      | Indicates the effect number or parameter   |
| 6   | Touchpad Mode Button         | Switches the touchpad between the Controller, KAOSS Effect, and Sampler modes (long press)         |
| 7   | Program/Value Knob           | Selects an effect  |
| 8   | Tap Button                   | Sets the tempo Long-press this button to access the auto BPM function                              |
| 9   | Hold Button                  | Enables/disables the touchpad's hold function  |
| 10  | Touchpad (controller mode)   | Controls the effects of the DJ software. The vertical axis controls the mix (dry/wet) knob and the |
|     | Touchpad (Kaoss Effect mode) | Controls the KAOSS effect  |
|     | Touchpad (sampler mode)      | Controls the sampler function of the DJ software   |
| 11  | Crossfader                   | Adjusts the balance between Decks A and B  |
| 12  | Touch Slider mode button     | Switches between the three touch slider mode   |
| 13  | Touch Slider (Normal mode)   | Left Side - Nudges (pitch -) Center - Enables the touch wheel's Scratch mode Right Side - Nudges   |
|     | Touch Slider (Hot Cue mode)  | Left Side - Sets Hot Cue 1, and moves to Hot Cue 1 Center - Sets Hot Cue 2, and moves to Hot Cue 2 |
|     | Touch Slider (Loop mode)     | Left Side - Auto Loop $\times$ 1/2 Center - Loop on/off Right Side - Auto Loop $\times$ 2          |
| 14  | EQ                           | Boosts or Cuts the Hi EQ Boosts or Cuts the Mid EQ Boosts or Cuts the Lo EQ                        |
| 15  | Gain knob                    | Adjusts the gain   |
| 16  | Load button                  | Loads the song into the selected deck  |
| 17  | Fx button                    | Left - FX1 rack mix knob can be manipulated when enabled Right - FX2 rack mix knob can be          |
| 18  | Headphone cue button         | Turns the headphone monitor on/off   |
| 19  | Touch wheel                  | Scratches (in scratch mode) or adjusts the pitch   |
| 20  | Pitch fader                  | Adjusts the pitch  |
| 21  | Level meter                  | Indicates the input level to deck A/B or the master level  |
| 22  | Shift button                 | Holding this button provides access to the controllers SHIFT functions                             |
| 23  | Play / pause button          | Starts/pauses the song   |
| 24  | Sync button                  | Synchronizes the tempo of Deck A and Deck B  |
| 25  | Cue button                   | Sets the cue point or moves to the cue point   |
| 26  | Level fader                  | Adjusts the level of deck A/B  |

### 17.1.56 Korg nanoKONTROL

This controller has been discontinued in favor of the *Korg nanoKONTROL 2*.

- [Forum thread](#)

Nuovo nella versione 1.8.2.

---

**Nota:** Unfortunately a detailed description of this controller mapping is still missing. If you own this controller, please consider [contributing one](#).

---

### 17.1.57 Korg nanoKONTROL2

There are two mappings for this controller included in Mixxx. The one labeled “Korg Nanokontrol 2 (alternative)” takes advantage of features introduced in Mixxx 2.0 such as master sync and cue modes.

- [Manufacturer’s product page](#)
- [Forum thread](#)

Nuovo nella versione 1.11.

---

**Nota:** Unfortunately a detailed description of this controller mapping is still missing. If you own this controller, please consider [contributing one](#).

---

### 17.1.58 Korg nanoPAD2

Nuovo nella versione 1.11.0.

---

**Nota:** Unfortunately a detailed description of this controller mapping is still missing. If you own this controller, please consider [contributing one](#).

---

### 17.1.59 M-Audio X-Session Pro

This device has been discontinued. M-Audio discontinued its DJ products after the company was bought by inMusic in 2012.

Nuovo nella versione 1.6.

---

**Nota:** Unfortunately a detailed description of this controller mapping is still missing. If you own this controller, please consider [contributing one](#).

---

### 17.1.60 M-Audio Torq Xponent

This device has been discontinued. M-Audio discontinued its DJ products after the company was bought by inMusic in 2012. This device is a class compliant USB audio and MIDI device, so it does not require a special driver on any OS that Mixxx runs on.

Nuovo nella versione 1.6.

---

## Note for Windows users

Typically, the ASIO sound API is the best option on Windows and it requires an ASIO driver from the sound card manufacturer. However, it seems that the current version of the Xponent ASIO driver for Windows interferes with the ability to send MIDI control messages to the Xponent. As a result, if you are running M-Audio's Xponent ASIO drivers on Windows, the lights will not work. If you uninstall the drivers, the lights will work, but you can no longer use the Xponent's sound card with the ASIO sound API.

It is recommended to **use the WDM-KS sound API** instead. The sound card will appear as "Analog Connector 1 (Xponent Audio)" and "Analog Connector 2 (Xponent Audio)". Connector 2 is the main out, and Connector 1 is the headphones. The latency meter seems to run a bit higher than it did under ASIO, so keep this in mind, and test both setups with your own system to see how they compare. If you require low latency as well as a lot of effects or time stretching, you may want to run with the ASIO driver at the expense of the lights.

---

**Nota:** Unfortunately a detailed description of this controller mapping is still missing. If you own this controller, please consider [contributing one](#).

---

### 17.1.61 Miditech Midicontrol

Nuovo nella versione 1.5.2.

---

**Nota:** Unfortunately a detailed description of this controller mapping is still missing. If you own this controller, please consider [contributing one](#).

---

### 17.1.62 Mixman DM2

- [Manufacturer's product page](#) (archived)

Nuovo nella versione 1.7.

---

**Nota:** Unfortunately a detailed description of this controller mapping is still missing. If you own this controller, please consider [contributing one](#).

---

### 17.1.63 MixVibes U-Mix Control (Pro) 2

The MixVibes U-Mix Control Pro 2 is a MIDI DJ controller with an **internal soundcard** and **two Inputs** for Turntables or any Audio-Source with RCA. It offers also a **changeable** Cross-fader, **adjustable** Cross-Fader **Curve** and **individual Touch-Level-Sensors**. The U-Mix Control **Pro** differs only in Cue-Button-Labels The U-Mix Control 2 (without "Pro" = internal soundcard) also. Both should work fine with this MIDI mapping.

- [Manufacturer's product page](#) (archived)
- [Forum thread](#)

Nuovo nella versione 1.10.1.

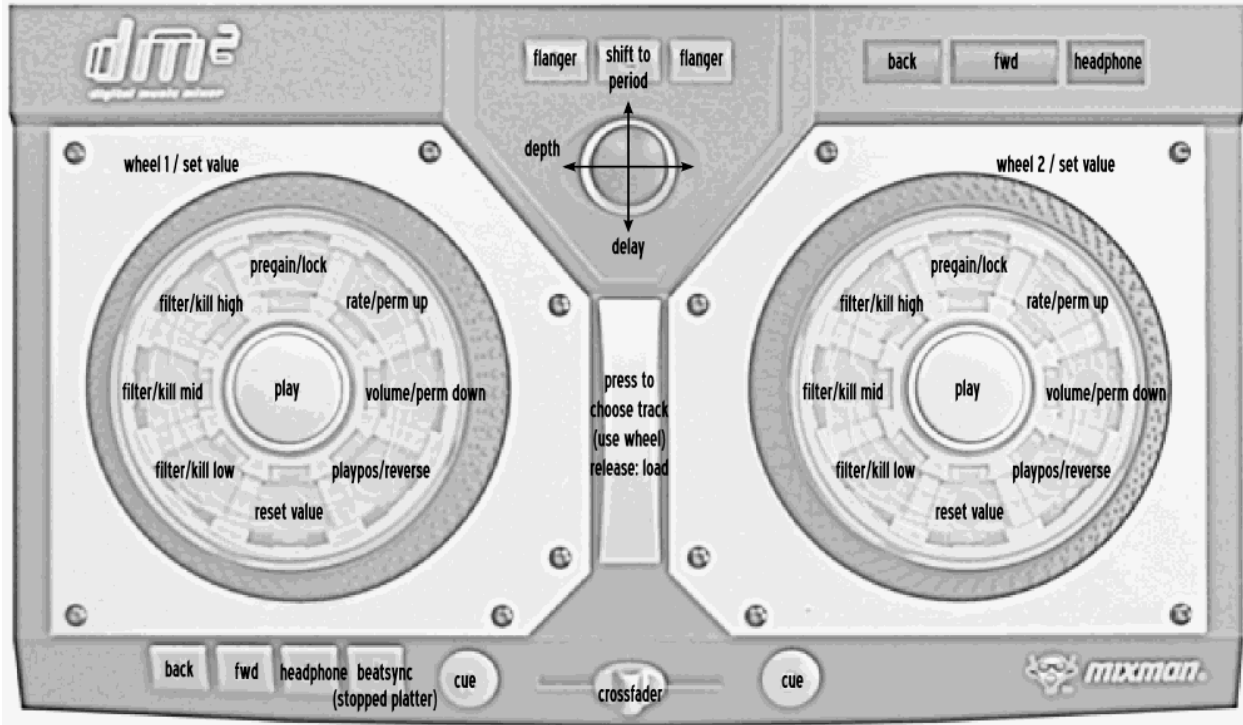

Figure28: Mixman DM2 (schematic view)

## Mapping description

- Cross- Volume- and Pitchbend-Slider
- Master, Gain- and EQ-Nobs incl. Kill-Switches, Cue/Master-Mix (Headphone)
- Cue-, Play-, Sync-, Pitchbend-, HotCue-, Headphone, Load A/B-Buttons
- JogWheels (incl. Scratch & Jog)
- MediaKnob
- LEDs
  1. Clipping
  2. EQ-Kill
  3. CUE/PLAY(BPM)/SYNC
  4. HotCUEs
  5. Headphone (A/B)
  6. Load (A/B) - 20 Seconds end of Track
  7. Jog (Keylock)
  8. Bend

## Special Functions

- BPM-Tap: Press “Shift” + “Sync”
- Keylock: Press “Jog”

**Currently not working**

- Sample-Deck-Management
- Loop-Knob & Loop-Setting

**Not MIDI-mappable**

- MIC-Level-Control (MIC is hardwired through master output)
- Headphone-Level Control (Level-Adjustment in Mixxx and the Hardware-Nob are independent)
- Touch Level sensitivity (only Hardware)
- C.F. Curve (turn to fully left and change in Mixxx, if needed)

**17.1.64 Native Instruments Traktor Kontrol F1**

The Traktor Kontrol F1 is a small versatile controller that is intended to be used for remix decks but can easily be repurposed for other uses such as hotcues.

- [Manufacturer's product page](#)

Nuovo nella versione 1.11.

---

**Nota:** Unfortunately a detailed description of this controller mapping is still missing. If you own this controller, please consider [contributing one](#).

---

**17.1.65 Native Instruments Traktor Kontrol S2 MK2**

The Native Instruments Traktor Kontrol S2 MK2 is a 2 deck all-in-one controller with an integrated audio interface. It has a pair of balanced 1/4» TRS outputs and a pair of unbalanced RCA outputs which both output the main mix, a 1/4» TRS headphone jack, and a 1/4» TRS microphone input. The microphone input is digitized and available to the computer for recording and broadcasting. The Kontrol S2 MK2 can run with only USB bus power and an optional power supply can be connected to make the LEDs brighter and the headphone output louder.

The Kontrol S2 MK2 can be distinguished from the Mk1 by the jog wheels. The top of the jog wheels on the MK2 are shiny aluminum; the top of the jog wheels on the Mk1 are black. The Kontrol S2 Mk3 does not have effects knobs at the top.

Nuovo nella versione 2.3.

**Compatibility**

The Kontrol S2 MK2 is a USB audio and HID class compliant device. It is fully compatible with Linux, Windows, and macOS. No proprietary driver is required on Linux or macOS. For Windows, download and install the latest driver from [Native Instruments' website](#).



## Audio routing

| Output            | Channels      |
|-------------------|---------------|
| <i>Master</i>     | Channel 1 - 2 |
| <i>Headphones</i> | Channel 3 - 4 |

| Input               | Channels      |
|---------------------|---------------|
| <i>Microphone 1</i> | Channel 1 - 2 |

Do *not* configure the *Record/Broadcast* input in Mixxx.

## Mapping

### Decks

### Jog Wheels

Touch the top of the jog wheel and turn it to scratch. Move the jog wheel from the edge without touching the top to nudge the track. Hold SHIFT and spin the jog wheel to seek quickly.

## Loop Section

The encoders work differently in Mixxx than in Traktor:

**Left encoder** Turning jumps forward/backwards by the beatjump size. If a loop is enabled, turning moves the loop by the beatjump size. Push and turn to adjust the beatjump size. Turning with SHIFT adjusts the musical key. Pushing with SHIFT resets the key to the track's default.

**Right encoder** Turning halves/doubles the loop size. Turning with SHIFT beatjumps by 1 beat forward/backward, or if a loop is enabled, moves the loop 1 beat forward/backward. Pushing (de)activates a loop. Pushing with SHIFT reactivates a disabled loop, or if a loop is enabled, jumps to the loop in point and stops the deck.

**LOOP IN/LOOP OUT buttons** Manually set the loop in and out points. Press and hold while moving the jog wheel to adjust the loop in or out point.

## Top Pad Row

The top pad row has 3 different modes.

**Hotcue mode** This is the default mode when Mixxx starts. The pads control hotcues 1-4. The color of the hotcues is shown on the pads. Press an unlit button to set a new *hotcue*. Press a lit pad to seek to the hotcue. Press a lit pad with SHIFT to delete the hotcue.

**Intro & Outro cue mode** This mode is activated by pressing the FLUX button above the tempo fader. Pads 1 & 2 are used for the intro start & end cues and light up green. Pads 3 & 4 are used for the outro start & end cues and light up red.

**Sampler mode** This mode is activated by the button under the Remix knob in the center of the mixer. Press an unlit pad to load the selected track in the library to the sampler. Loaded and stopped sampler pads are lit white. Press a white pad to play a sampler. A playing sampler is lit magenta. Press a lit pad with SHIFT to stop a sampler, or if it is already stopped, unload the sample.

## Transport Controls

The transport controls work mostly as labelled on the controller:

**SYNC button** Press to *sync tempo*. Press and hold to enable sync lock. Press again to disable sync lock. Press with SHIFT to enable sync lock without needing to hold.

**CUE button** Behavior depends on the *cue mode set in the Mixxx preferences*. Press with SHIFT to seek the beginning of the track and stop.

**PLAY button** Play or pause the deck. Press with SHIFT to toggle key lock.

**TEMPO fader** Adjusts the *tempo*.

**FLUX button** Mixxx *does not yet have a very useful flux/slip mode*, so instead this button toggles the top pad row to the intro/outro cues. Press the button when it is lit to return the top pad row to hotcue mode.

When slip mode is implemented in Mixxx in the future, this could be changed so SHIFT + FLUX button activates intro & outro mode for the pads.

## Mixer

### Deck Columns

**GAIN\FILTER encoder** Controls the Quick Effect superknob for the deck. With SHIFT, controls gain. Press to reset the Quick Effect superknob. Press with SHIFT to reset gain.

**FX 1/FX 2 buttons** Assign the deck to effect units 1 and 2.

**HI/MID/LOW knobs** Adjust the high, middle, and low frequencies.

**CUE button** Toggle whether the deck is routed to the *prefader headphone output*. With SHIFT, toggle quantize for the deck.

**Fader** Control the deck volume.

### Center Column

**MAIN LEVEL knob** Adjust the volume of the main output. This acts on the controller's audio interface output in hardware, so it is not mapped to the main mix gain knob in Mixxx (otherwise the gain would be applied twice).

**REMIX knob** Adjusts the gain of samplers 1-8.

**REMIX ON A/REMIX ON B buttons** Toggles the top pad row of the corresponding deck to control samplers. Press when lit to return the pads to controlling *hotcues*.

**BROWSE encoder** Scroll through the music library. Push to maximize the library browser on screen. Turn with SHIFT to scroll 5 rows at a time.

**LOAD A/LOAD B buttons** Load the track selected in the library to the corresponding deck. Press with SHIFT to unload a track.

**LEVEL meters** The meters show the levels for each deck.

**Crossfader** Crossfade between the decks.

## Effects

The Kontrol S2 MK2 uses the [standard Mixxx effects mapping](#).

## Front panel

The cue volume knob adjusts the volume of the controller’s audio interface in hardware, so it is not mapped to Mixxx (otherwise the gain would be applied twice). The cue mix knob is mapped to Mixxx. The Mic Engage button toggles talkover for Microphone Input 1 in Mixxx.

### 17.1.66 Native Instruments Traktor Kontrol S2 MK3

The Kontrol S2 MK3 is a two-channel controller with an integrated sound card. It has two integrated stereo outputs (line and 1/8» / 3.5 mm TRS), headphone outputs (1/8» / 3.5 mm TRS) and microphone inputs (1/4» / 6.3 mm TRS). The MK3 uses the standard HID protocol to send and receive signals from a computer, so it can work with Mixxx. The Kontrol S2 MK3 can run from USB bus power, and using a separate power supply has no impact on the output level or LED brightness (as opposed to the MK2).

- [Manufacturer’s product page](#)
- [Mapping forum thread](#)

Nuovo nella versione 2.2.4.

Cambiato nella versione 2.3: Unbind Master knob from Mixxx’s Main Gain, because it controls the hardware volume.

## Mixxx Sound Hardware Preferences

- Master output: channels 1-2
- Headphone output: channels 3-4

## Mixxx mapping

| Element                 | Primary function  | Secondary function (+ SHIFT)               |
|-------------------------|---|--|
| (1) REV Button          | Reverse play while held   | Reverse play + slip mode while held        |
| (2) FLX Button          | Enable and disable slip mode  |  |
| (3) Browse knob (turn)  | Scroll vertically in library  | Scroll horizontally in library             |
| (3) Browse knob (press) | Load selected track into deck   | Eject current track                        |
| (4) Preparation button  | Add selected track to AutoDJ queue (bottom)   | Add selected track to AutoDJ queue (top)   |
| (5) List view button    | Toggles maximizing the library  |  |
| (6) Sync button         | Syncs the BPM and phase (depending on quantize). Press longer to activate master sync on that deck. | Syncs the phase to that of the other track |
| (7) Keylock button      | Enable keylock for the deck   |  |

continues on next page

Table 7 – continua dalla pagina precedente

| Element                | Primary function  | Secondary function (+ SHIFT)  |
|------------------------|---|---|
| (8) Loop knob (turn)   | Halve or double loop size   |   |
| (8) Loop knob (press)  | Set a loop of the defined number of beats and enables the loop  | Toggles the current loop on or off                                  |
| (9) Samples button     | Active sampler mode (for the number buttons)  |   |
| (10) Hotcues button    | Activate hotcue mode (for the number buttons)   |   |
| (11) Move knob (turn)  | Beatjump backwards/forwards   | Halve or double beatjump size                                       |
| (11) Move knob (press) | Activates a rolling loop of the defined number of beats. Once disabled, playback will resume where the track would have been if it had not entered the loop | Activate current loop, jump to its loop in point, and stop playback |
| (12) Jog wheels        | Control scratching when touched from the top ( <i>Missing: temporarily bend the pitch when touched from the side</i> )                                      |   |
| (13) Grid button       | Adjust beatgrid so closest beat is aligned with the current play position   | Adjust beatgrid to match another playing deck                       |
| (14) Shift button      | Activates secondary functions when pressed  |   |
| (15) CUE button        | CUE default   | If the CUE point is set, jump to it and stops                       |
| (16) Play button       | Toggles playing   | Seeks a player to the start and then stops it                       |
| (17) Number buttons    | Function depends on current mode  |   |
| Hotcue mode            | If hotcue is set, seeks the player to hotcue position. Otherwise set hotcue at current position   | Clear the hotcue  |
| Samples mode           | If track is loaded into corresponding slot, go to CUE point and play  | If track is playing, CUE default behaviour. Otherwise eject track   |
| (18) Tempo fader       | Speed control   |   |
| (19) Quantize button   | Toggles quantization for both decks   |   |
| (20) Gain knob         | <i>Unmapped</i> (adjusts the hardware gain)   |   |
| (21) Microphone button | Toggles microphone talkover, long press for permanent activation  |   |
| (22) Pre-Gain knob     | Adjusts the pre-fader gain of the deck  |   |
| (23) HI knob           | High frequency filter   |   |
| (24) MID knob          | Middle frequency filter   |   |

continues on next page

Table 7 – continua dalla pagina precedente

| Element                  | Primary function  | Secondary function (+ SHIFT) |
|--------------------------|---|------------------------------|
| (25) LOW knob            | Low frequency filter  |                              |
| (26) Effect Superknob    | Quick effect superknob for the corresponding deck           |                              |
| (27) Sample knob         | Adjusts the pregain for all the sample decks combined       |                              |
| (28) Headphone mix knob  | Adjusts the cue/main mix in the headphone output            |                              |
| (29) Headphone gain knob | Adjusts the headphone output gain                           |                              |
| (30) Effect buttons      | Enable or disable effect units for both decks               |                              |
| (31) Headphone buttons   | Toggles headphone cueing                                    |                              |
| (32) Volume fader        | Adjusts the channel volume fader for the corresponding deck |                              |
| (33) VuMeter LEDs        | Show the current instantaneous deck volume                  |                              |
| (34) Crossfader          | Adjusts the crossfader between both decks                   |                              |

### 17.1.67 Native Instruments Traktor Kontrol S3

The Kontrol S3 is an introductory 4 deck controller with good build quality and integrated sound card. This is the first controller released with the «S3» name.

The Kontrol S3 can run from USB bus power. Using the separate power supply increases the brightness of the LEDs, which is helpful for using it in daylight, and increases the volume of the headphone output.

- [Manufacturer's product page](#)

Nuovo nella versione 2.3.0.

#### Compatibility

##### Controller

The Kontrol S3 is a USB class compliant audio and *HID* device, so it is compatible with Mixxx without any proprietary drivers on GNU/Linux and macOS. On Windows, it is recommended to install the [driver from Native Instruments](#) and select the ASIO *sound API* in the *Sound Hardware section of Mixxx's Preferences*.

With the S3 plugged in, the device is listed as an available controller in Mixxx's Preferences. The controller uses HID for the knobs, buttons, and other components on the device, so the mapping can only be loaded when you select the HID device on the left side of Mixxx's Preferences.

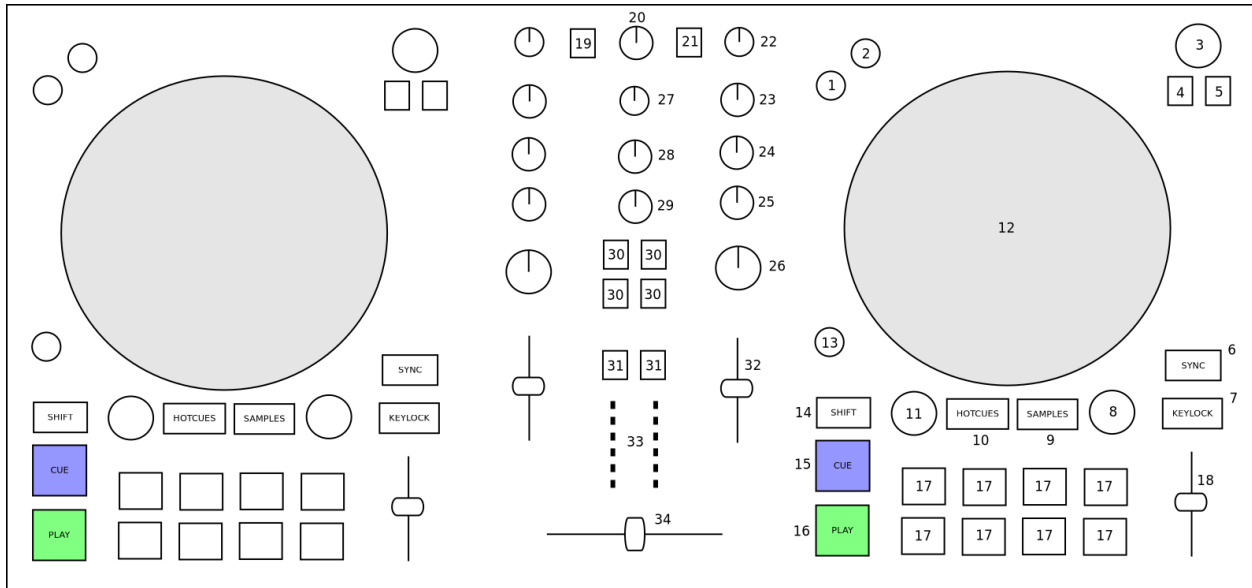

Figure29: Native Instruments Traktor Kontrol S2 MK3 (schematic view)

### Audio Hardware setup

The S3 has a standard 4 channel sound card. You should configure the channels as follows:

| Audio Output | Channel Configuration |
|--------------|-----------------------|
| Master       | Channel 1-2           |
| Headphones   | Channel 3-4           |

### Audio Inputs

The S3 has two sets of inputs, but only one can be active at a time. There is a set of line-level RCA inputs on the back of the controller, and a combo XLR / 1/4» mic jack on the front. Use SHIFT + EXT to switch between these inputs.

### Mapping description

Note that Mixxx doesn't have the concept of a single «leader» deck for sync. Instead, push and hold the SYNC button to «lock» sync on for all decks you want to remain in sync. Or you can push SHIFT + SYNC to lock sync on. Refer to [Sync Lock documentation](#) for details.

---

**Suggerimento:** There are two SHIFT buttons, one for each side of the controller. Make sure you press the SHIFT button on the same side as the control you want to modify.

---

## Mixer

- The GAIN and equalizer HIGH/MID/LOW knobs and the CUE (headphones) button behave as labelled.
- FX Enable buttons: See Effect section below.
- The FILTER knob controls the Quick Effect superknob. By default, this uses a high-/low-pass filter, but a different effect can be chosen in the *Equalizer section of Mixxx's Preferences*.
- EXT: The EXT button changes the fourth channel pregain (knob), pfl, and volume (slider) adjustments to operate with the Microphone input. The microphone does not respond to EQ or effects.
- SHIFT + EXT: Switches input sensitivity for the input connectors from Mic to Line and back again.

The Main Volume knob on the S3 controls the volume of the S3's main output in hardware, so it does not affect the software main output gain knob in Mixxx by default. You can hold SHIFT and turn the knob to adjust Mixxx's main output gain. Note that this will still also adjust the hardware gain, so after you release SHIFT you'll need to adjust the knob again.

Peak display is only generated from software. So if you see clipping indicated, lower the gain of the playing decks or use SHIFT + Main Volume knob.

## Decks

| Control                       | Description   |
|-------------------------------|---|
| Library encoder press         | Load track selected in library to the deck.   |
| SHIFT + Library encoder press | Eject track.  |
| Small play button             | While held, plays the current track in the preview deck. If you rotate the library encoder while you hold the PLAY button, Mixxx will scan through the track being previewed. |
| Star button                   | This button is not used.  |
| List-plus button              | Adds the current track to the Auto DJ list.   |
| VIEW button                   | Move focus of library control between left-hand tree and main list.   |

## Transport Mode Buttons

| Control        | Description   |
|----------------|---|
| REV            | Activates a reverse-roll (aka «censor») effect.             |
| SHIFT + REV    | Turns on reverse playback mode.                             |
| GRID           | Turns on Quantize mode.                                     |
| FLUX           | Turns on Slip mode.   |
| JOG            | When on, touching the jog wheels enables Scratch mode.      |
| SHIFT + Wheels | Hold to use the wheels to quickly scroll through the track. |

## Looping

| Control                     | Description   |
|-----------------------------|---|
| Right Encoder Turn          | Double/halve loop size.   |
| SHIFT + Right Encoder Turn  | Move loop forward/backward by the beatjump size.                        |
| Right Encoder Press         | Activate loop of set size from current position, or disable active loop |
| SHIFT + Right Encoder Press | Toggles the existing loop on and off.                                   |
| Left Encoder Turn           | Beatjump forward/backward.  |
| SHIFT + Left Encoder Turn   | Adjust beatjump size.   |
| Left Encoder Press          | Activates beatloop roll.  |
| SHIFT + Left Encoder Press  | Activates a loop and then stops.  |

## Rate / Keylock

There are two ways the rate sliders can be mapped: Absolute, and Relative. Absolute mode is the default. In this mode, the position of the pitch slider matches the on-screen pitch slider position. If the sliders are misaligned, Mixxx engages «soft takeover mode» – Mixxx won't update the value of the slider until the controller matches the GUI. In Relative mode, moving the slider always adjusts the value of the pitch slider, even if they don't match.

- Absolute Mode:
  - KEYLOCK: Press to toggle keylock mode.
  - SYNC: Press to beatsync, or press and hold to activate Sync Lock Mode.
  - Pitch slider: Adjusts playback speed.
  - SHIFT + Pitch slider: Adjusts musical key
- Relative Mode:
  - KEYLOCK: Press to toggle keylock mode (toggles when releasing the button).
  - SYNC: Press to beatsync, or press and hold to activate Sync Lock Mode.
  - Pitch slider: Adjusts playback speed.
  - Keylock + Pitch Slider: adjusts musical key
  - SHIFT + Pitch Slider: Allows the user to move the slider without any effect.

## Button Pads

The grid of 8 buttons have two possible trigger modes: Hotcues, and Samplers.

In Hotcues mode, pressing the number button will set the hotcue if none exists, and activate it if one does. If you hold SHIFT and press a button, it will clear that hotcue.

In Samplers mode, the buttons on the left side of the controller correspond to Samplers 1-8. The buttons on the right side of the controller correspond to Samplers 9-16. By default, pressing a number button will activate a sample. Pressing the button again will stop sample playback.

You can change this behavior by editing the javascript file to set `TraktorS3.SamplerModePressAndHold = true;`. In this mode, the sample will play while the button is held, and stop when you let go.

In both modes, holding SHIFT and pressing a button will eject the sample if it is not playing, and will rewind the sample back to the beginning if it was playing.



## Effects

Because the S3 has limited effects controls, the FX setup is unusual and a little complex. Each deck has a single effect toggle button and one knob, and on the right-hand side of the mixer there are five buttons, one for each effect chain and one for the QuickEffect. These buttons and knobs are used in different ways depending on how they are pushed, and together allow the DJ to customize all of the effects.

There are three modes that the effect controls can be in: 1. The initial mode is Filter Mode. This mode is indicated when the FILTER ENABLE buttons have the same colors as the individual decks. This mode is used for adjusting QuickEffects and assigning Effect Chains to decks. 1. The next mode is Effect Chain Edit Mode. This mode is indicated when the FILTER ENABLE buttons are all the same color as one of the effect buttons. This mode is used for turning individual effects in a chain on and off, and adjusting each effect chain's mix knob. 1. The last mode is Effect Focus Mode. This mode is indicated when FILTER ENABLE buttons are all the same color as one of the effects, and one of the FX SELECT buttons is blinking. This mode is used for tuning individual parameters in an effect and enabling or disabling effect toggle buttons.

## Switching Effect Modes

At any time, you can push the FILTER FX SELECT button to return to Filter Mode. If you get lost, try pushing the FILTER button to start over.

Press any FX SELECT button to enter Effect Chain mode for that number chain. If you press the same FX SELECT button again, you'll return to Filter Mode. Press a different FX SELECT button to enter Effect Chain mode for that other chain.

Press and hold an FX SELECT button, then press a FILTER ENABLE button to enter Effect Focus mode. The FX SELECT button will start blinking. From left to right, the FILTER ENABLE buttons will focus on the first through fourth effects in the chain. If you press any FX SELECT button, you'll return to Effect Chain mode.

## Soft Takeover

The knobs have Soft Takeover mode enabled, which means you need to turn the physical knob to match the current position of the UI knob before the value will change. If you are wondering why it seems like the values aren't changing, you may need to rotate the knob more.

## Assigning Effects

You can assign effect chains to individual decks in Filter Mode. Press and hold FILTER ENABLE, then press the desired FX SELECT button or buttons. The FX SELECT buttons that are bright are the effect chains that are selected for that deck.

## Effect Chain Edit Mode

In Effect Chain Edit Mode, the FILTER ENABLE buttons change color to match the selected FX button. The lights will be dim if the effect is disabled, and bright if it is enabled. Tap the FILTER ENABLE button to enable or disable the effect. Turn the first three knobs to adjust the meta knob for each effect. The last filter knob adjusts the mix knob for the whole chain. This is to prevent sudden changes in sound when navigating between modes.

## Effect Focus Mode

In Effect Focus Mode, the FILTER ENABLE buttons represent effect button parameters, while the four knobs adjust the first four parameters of the selected effect.

## Mapping options

There are two user-friendly customizations possible on the S3:

1. Toggle between Absolute and Relative pitch slider mode.
2. Customize the colors for decks A, B, C, and D.
3. Change the Sampler playback mode.
4. Whether wheel touch scratching is on by default.

To make these changes, you need to edit to the mapping script file.

1. Open Mixxx Preferences and select the Kontrol S3 in the side list.
2. There will be a box labeled *Mapping Info*, and that box will have a section labeled *Mapping Files*.
3. Select `Traktor-Kontrol-S3-hid-scripts.js`.
4. Either the file should open in an editor, or you should see a file browser window with that file selected. If you see a file browser, right click the file and select an option to edit it.
5. At the top of the file will be short instructions explaining how to edit the file.

Changes you make will take effect as soon as you save the file.

### 17.1.68 Native Instruments Traktor Kontrol S4 MK2

The Kontrol S4 MK2 is a 4 deck all-in-one controller with a sturdy build quality and integrated sound card. The MK2 has substantial improvements over the S4 MK1, including large multicolor buttons. The MK1 is not supported and cannot be supported because it uses a proprietary communication protocol exclusive to Traktor. The MK2 uses the standard *HID* protocol (also used by keyboards & mice) to send and receive signals from a computer, so it can work with Mixxx. The easiest way to tell the MK1 apart from the MK2 is the appearance of the jog wheel. On the MK1, the top of the jog wheel is black plastic; on the MK2, the top of the jog wheel is shiny aluminum.

The Kontrol S4 Mk2 can run from *USB* power. Using the separate power supply increases the brightness of the LEDs, which is helpful for using it in daylight, and increases the volume of the headphone output.

- [Manufacturer's product page](#)

Nuovo nella versione 2.1.

## Compatibility

### Controller

The Kontrol S4 MK2 is a USB class compliant audio, *HID* and *MIDI* device, so it is compatible with Mixxx without any proprietary drivers on GNU/Linux and MacOS. On Windows, it is recommended to install the [driver from Native Instruments](#) and select the *ASIO sound API in the preferences*.

With the S4 plugged in, a MIDI device is listed as an available controller in Mixxx's Preferences. That is the MIDI input/output ports on the back of the S4 for connecting external MIDI gear; no mapping for the S4 will appear in the

menu for the MIDI device. The controller uses HID for the knobs, buttons, and other components on the device, so the mapping can only be loaded when you select the HID device on the left side of Mixxx's Preferences.

### Timecode vinyl

The phono inputs on the S4 can be used with turntables for timecode vinyl control of Mixxx.

#### Vedi anche:

Read the *Vinyl Control section* for details.

### Mapping Description

Push and hold the SYNC button to “lock” sync on for all decks you want to remain in sync. Push SHIFT + SYNC to enable *Sync Lock* for details.

Mixxx does not have remix decks, so the four remix slot buttons control the samplers. There are some more bonus actions that can be accessed by holding SHIFT and pressing certain buttons.

### Mixer

| Control                   | Description  |
|---------------------------|--|
| FILTER knob               | Controls QuickEffect superknob. This controls the Filter effect by default, but a different effect can be chosen in the Equalizer section of Mixxx's Preferences.                  |
| SNAP                      | Toggles library fullscreen   |
| LOOP RECORD               | Toggles recording  |
| LOOP RECORDER PLAY        | Hold down and press FLUX button on a deck to enable autoslip mode on that deck.  |
| SHIFT + Gain              | Up/down will move the beatgrid   |
| LOOP RECORDER PLAY + GAIN | Increase / decrease the BPM of the track by 0.5. Press the encoder to round the track the nearest whole BPM. Best done to fix tracks with the wrong BPM with the pitch fader at 0. |
| BROWSE encoder            | Up/down will browse in the focused library pane. Pressing acts like a double click on the mouse.   |

GAIN, effects routing, equalizer high/mid/low, and CUE (headphones) behave as labeled.

The Master Volume knob on the S4 controls the volume of the S4's master output in hardware, so it does not affect the software master gain knob in Mixxx. Peak display is only generated from software, however. So if you see or hear clipping, lower the gain of the playing decks; adjusting the master volume knob on the S4 will not help.

## Decks

| Control                                  | Description   |
|--|---|
| LOAD                                     | Load track selected in library to the deck.   |
| SHIFT + LOAD                             | Eject track   |
| Small buttons with preview icons         | Play a sampler from its cue point. If no track is loaded in the sampler, the track selected in the library will be loaded.                  |
| SHIFT + small buttons with preview icons | If sampler is playing, stop it. If sampler is not playing, the loaded track is ejected from the sampler.                                    |
| 1-4 numbered buttons                     | Set/activate <i>hotcue</i>  |
| SHIFT + 1-4 numbered buttons             | Clear hotcue  |
| SHIFT + Wheel nudge                      | Fast search through track when not playing  |
| FLUX button                              | Enable slip mode (if shift is held down this decreases the range of the BPM slider, if LOOP RECORDER PLAY is held down enter autoslip mode) |
| RESET button                             | Reset key (if shift is held down increase the range of the BPM slider)  |

## Looping

| Control                       | Description   |
|-------------------------------|---|
| Right Encoder (turn)          | Double/halve loop size. The loop size is shown on the controller. A dot on the right indicates a fractional loop size. Two dots indicates a loop size larger than 99 beats. |
| Right Encoder (press)         | Activate loop of set size from current position   |
| SHIFT + Right Encoder (turn)  | Adjust key  |
| SHIFT + Right Encoder (press) | Reset key   |
| Left Encoder (turn)           | Beatjump forward/backward by beatjump size (shown on screen but not on controller), or move the loop by beatjump size if there is a loop enabled                            |
| Left Encoder (press)          | Re-enable a loop that has been set previously. Pressing this before a loop will keep playing until the loop is entered.   |
| SHIFT + Left Encoder (turn)   | Adjust beatjump size  |
| SHIFT + Left Encoder (press)  | Jump to loop in point, activate loop, and stop playback. This is helpful for preparing to mix a track in with a loop.   |
| IN button                     | Set loop in point manually. Hold pressed while moving the jog wheel to finely adjust the loop in point.   |
| OUT button                    | Set loop out point manually. Hold pressed while moving the jog wheel to finely adjust the loop out point.   |

## Effects

The knob on the left of each effect unit controls the mix (dry/wet) knob for all 3 effects in the unit. The other knobs control the metaknobs of the effects. The buttons below the metaknobs control the effect enable buttons. When pressed with shift, they cycle through the available effects. The button below the mix knob toggles whether the effect parameters are showing on screen. This will be expanded in a future update to implement the [Standard Effects Mapping](#).

The buttons at the top of each mixer column control which decks are routed to which effects units.

## Mapping extras

Autoslip mode: Holding down LOOP RECORDER PLAY and pressing the FLUX on a deck will enable autoslip mode on that deck. Autoslip turns on slip mode automatically before doing certain actions and turns it off after the actions is finished. It works for beat loops, hot cues, and scratching (warning, can have weird effects when scratching).

## Mapping options

If you choose, you can edit the controller script and change the Remix Slot buttons to perform loop rolls instead. Also by default, SHIFT + CUE rewinds the track to the beginning but you can change this to a Reverse Roll (or “Censor”) effect instead.

Making these changes is still a little awkward and we will be making controller preferences easier to change in the future. For now you’ll have to make a small change to the mapping script file. Don’t worry, the actual edit only involves replacing a single word in a text file.

1. Open Mixxx Preferences and select the Kontrol S4 in the side list.
2. Select `Traktor-Kontrol-S4-MK2-hid-scripts.js`.
3. Click *Open Selected File*.
4. Either the file should open in an editor, or you should see a file browser window with that file selected. If you see a file browser, right click the file and select an option to edit it.
5. At the top of the file will be short instructions explaining what to do.

### 17.1.69 Native Instruments Traktor Kontrol X1

Nuovo nella versione 1.11.0.

---

**Nota:** Unfortunately a detailed description of this controller mapping is still missing. If you own this controller, please consider [contributing one](#).

---

### 17.1.70 Nintendo Wiimote

The Wiimote is a motion-sensitive wireless game console controller.

- [Forum thread](#)

Nuovo nella versione 1.11.

### 17.1.71 Novation Dicer

- [Manufacturer's product page \(archived\)](#)
- [Forum thread](#)

The Novation Dicer is a small controller designed to be placed on the corner of turntables for use with timecode vinyl. They are sold in pairs.

Nuovo nella versione 1.10.

#### Mapping description

The mapping has all buttons mapped and mimics the overall layout of the [DJ Tech Tools Dicer](#) mapping for Traktor.

### 17.1.72 Novation Launchpad Mini

- [Manufacturer's product page](#)
- [Forum thread](#)

Nuovo nella versione 2.0.

---

**Nota:** Unfortunately a detailed description of this controller mapping is still missing. If you own this controller, please consider [contributing one](#).

---

### 17.1.73 Novation Launchpad MK1

- [Forum thread](#)

Nuovo nella versione 1.11.

Cambiato nella versione 2.1.

This device is not USB MIDI class compliant. Its signals are translated to MIDI by special drivers on Windows and Mac OS X. There is no driver available for Linux. It has been discontinued in favor of the [Novation Launchpad MK2](#) which is USB MIDI class compliant and has RGB pads.

---

**Nota:** Unfortunately a detailed description of this controller mapping is still missing. If you own this controller, please consider [contributing one](#).

---

### 17.1.74 Novation Launchpad MK2

Novation Launchpad MK2 is an updated versions of the Launchpad. It introduces new features such as RGB, velocity sensitive pads, and a redesigned layout scheme.

Nuovo nella versione 2.1.

---

**Nota:** Unfortunately a detailed description of this controller mapping is still missing. If you own this controller, please consider [contributing one](#).

---

### 17.1.75 Novation Twitch

Nuovo nella versione 2.1.

---

**Nota:** Unfortunately a detailed description of this controller mapping is still missing. If you own this controller, please consider [contributing one](#).

---

### 17.1.76 Numark DJ2GO

- [Manufacturer's product page](#)

Nuovo nella versione 1.10.

---

**Nota:** Unfortunately a detailed description of this controller mapping is still missing. If you own this controller, please consider [contributing one](#).

---

### 17.1.77 Numark DJ2GO2 Touch

The Numark DJ2GO2 Touch is a USB *MIDI* controller with an integrated audio interface. It is the successor to the DJ2GO2, and features touch capable wheels.

- [Manufacturer's product page](#)
- [Mapping Forum Thread](#)

Nuovo nella versione 2.3.1.

#### Audio Setup

The mapping relies on the following channel assignments:

| Output Channels | Assigned to |
|-----------------|-------------|
| 1-2             | Master      |
| 3-4             | Headphones  |

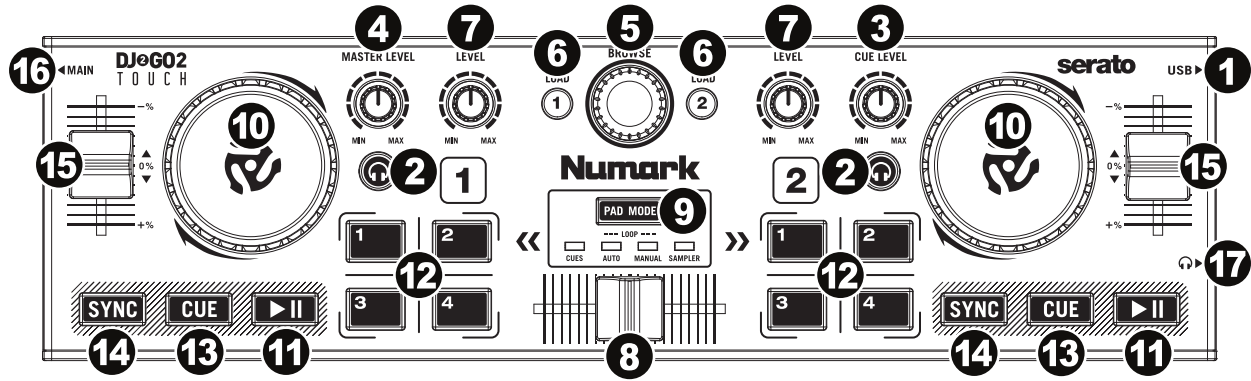

Figure30: Numark DJ2GO2 Touch (schematic view)

## Controller Mapping

### Decks

| No. | Control                 | Function   |
|-----|-------------------------|--|
| 2   | HEADPHONES              | Routes deck to headphones output                                   |
| 6   | LOAD                    | Loads a track into the deck.                                       |
| 7   | LEVEL                   | Hi / low pass filter effect.                                       |
| 9   | PAD MODE                | Switches between modes of operation for pad buttons on both decks. |
| 10  | Jog Wheel (top surface) | Perform scratch operation.   |
| 10  | Jog Wheel (outer edge)  | Rotate to lower/raise playback speed and pitch.                    |
| 11  | PLAY/PAUSE              | Plays or pause the song.   |
| 12  | Pads                    | 4 buttons which can be used to control various features.           |
| 13  | CUE                     | Specifies, plays or recalls temporary cue point.                   |
| 14  | SYNC                    | Match tempo and phase of other deck.                               |
| 15  | Tempo slider            | Adjust song playback speed.  |

### Pads

The pad mode is changed using the PAD MODE button.

| Pad Mode | Function  |
|----------|---|
| CUES     | Set cue points, and trigger them by clicking.   |
| AUTO     | Enable / disable beat loops, with pads 1, 2, 3, and 4 creating 1, 4, 8, and 16 bar loops respectively.  |
| MAN-UAL  | Set a custom loop: pad 1 sets the loop in point, pad 2 sets the loop out point, pad 3 enables / disables the loop, and pad 4 stops the loop and returns to the beginning. |
| SAM-PLER | Load / trigger sample tracks.   |



## Mixer / Library

| No. | Control        | Function  |
|-----|----------------|---|
| 3   | CUE LEVEL      | Adjusts the cue output level.   |
| 4   | MAS-TER LEVEL  | Adjusts the master output level.  |
| 5   | Browse encoder | Scroll in the track list. Preview tracks when clicking on a track in a tracklist, scrolling the encoder allows seeking the previewed track. Clicking when a track is being previewed will stop the preview, allowing you to scroll the tracklist again. |
| 8   | Cross-fader    | Fades between left and right deck.  |

## Inputs / outputs

| No. | IO                 | Function   |
|-----|--------------------|--|
| 1   | USB                | Micro USB slot for data / power connection to the Mixxx host device. |
| 16  | Main (3.5mm)       | Master audio output for the onboard interface.                       |
| 17  | Headphones (3.5mm) | Headphones audio output for the onboard interface.                   |

### 17.1.78 Numark iDJ Live II

The Numark iDJ Live II is a budget MIDI controller similar to the *Discover DJ* <*ion-discover-dj*>. It does not have a built in sound card, so a *splitter cable* or a *separate audio interface* is required to use headphones with it.

- [Manufacturer's product page](#)

Nuovo nella versione 2.3.0.

### Compatibility

This controller is USB *MIDI* class compliant, so it is plug-and-play on all platforms without having to install any special drivers.

### Button mapping

Most of the mapping is self-explanatory and matches up to labels in the Mixxx *GUI*. The mapping script only handles the jog wheels and scratch button, so you can remap everything else using the learning wizard if you'd like.

## Play/Cue/Sync buttons

Despite their appearance, the cue buttons don't seem to have LEDs. Only the play and sync buttons do.

The «SET» buttons set the cue point and the arrow buttons jump to the cue point. They do not change behavior depending on whether the track is playing or paused.

## Jog wheels and scratch button

The scratch button in the middle changes the mode of the jog wheels. When the scratch LED is off, you can use the wheels to adjust the pitch of a playing track, or to quickly search through a paused track. The search mode moves exactly 32 beats for each revolution of the jog wheel.

## Browse knob

The browse knob scrolls through your library, and the 1 and 2 buttons below it load a track into the corresponding deck. Pressing down on the Browse knob toggles fullscreen library view.

## 17.1.79 Numark Mixtrack

This controller is the same as the *Numark Mixtrack Pro* but without a built-in sound card. It has been discontinued and succeeded by the *Numark Mixtrack 3*.

- [Manufacturer's product page](#)
- [Forum thread](#)

Nuovo nella versione 1.8.2.

### Mapping Description

1. USB cable
2. Channel Treble
3. Channel Mid
4. Channel Bass
5. Cue: send the corresponding track to the headphones
6. Cue Gain: adjust audio level of cue channel
7. Cue Mix: adjust mix between Cue and Audio out in the headphones.
8. Browser Knob: help browse through your collection without using a mouse or trackpad
9. Back: takes you up one level in your file hierarchy
10. Load A/Load B: Load the highlighted track to the corresponding Deck
11. Channel faders: control the volume of each channel
12. Master fader: adjust the output volume of mixxx
13. Crossfader
14. Jog Wheels (see below for details)

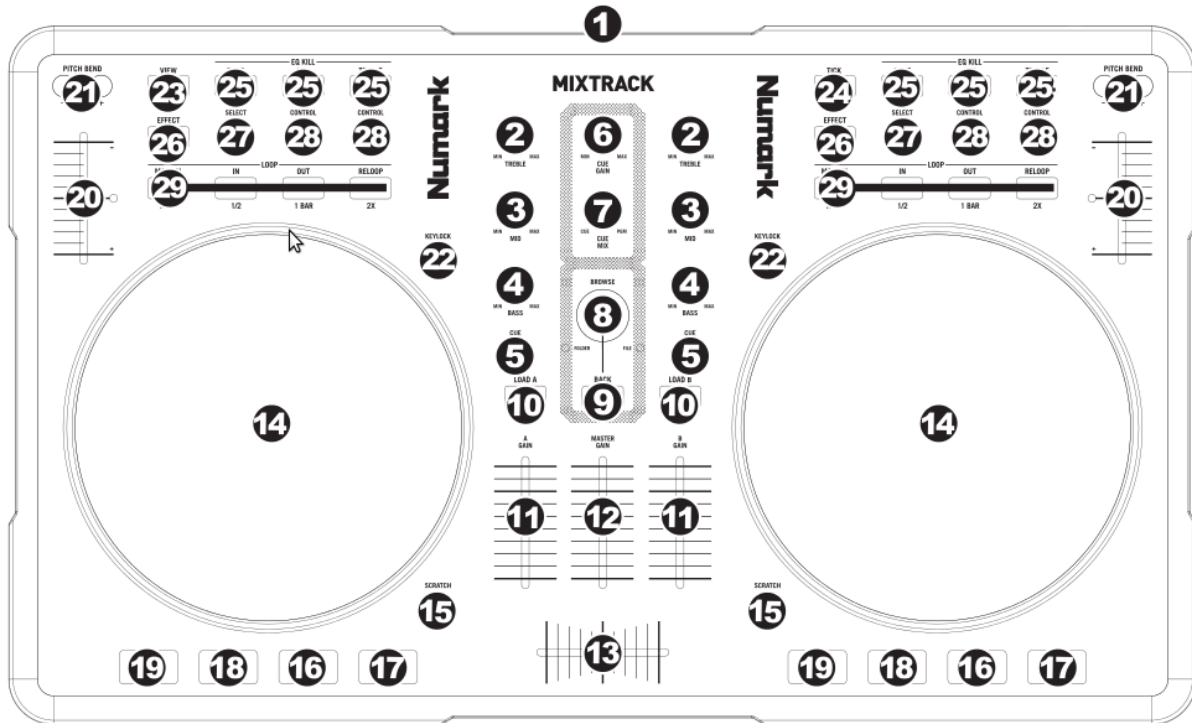

Figure31: Numark Mixtrack (schematic view)

- 15. Scratch mode (see below for details)
- 16. Play/Pause
- 17. Stutter: press while music is playing to jump back to the cue point
- 18. CUE: plays from the cue point if hold. When released, jumps back to the cue point
- 19. SYNC: automatically matches the corresponding Deck's tempo to the other Deck's tempo
- 20. Pitch Faders
- 21. Pitch Bend: when pressed, the pitch will adjust  $\pm 4\%$ , when released, the tempo will set back to the right one
- 22. Keylock
- 23. View: dynamically set cue point for Deck A
- 24. Tick: dynamically set cue point for Deck B
- 25. Eq Kill Switches
- 26. Effect On/Off: turn on/off the flanger effect
- 27. On Deck A: control the Flanger's LFO (unassigned on Deck B)
- 28. On Deck A: control the Flanger's Depth and delay (unassigned on Deck B)
- 29. Loop Mode: press to alternate between manual or autolooping
  - Manual Looping
    - In: set loop start
    - Out: set loop end

- Re-loop: exit or reenter loop
- Auto Looping
  - 1/2 X: divide loop length by 2
  - 1 Bar: make a loop of just one bar (the current one)
  - 2 X: multiply loop length by 2

## The Jogs

### Not in scratch mode

When not in scratch mode, touching the jogs won't pause the song. Turning them will slightly adjust the tempo, which will resume slowly to its speed. This slowness to resume is somehow equivalent to what you would expect from drivebelt turntables. I hate it, and I have not found a way to correct it... This is why I mostly mix using the pitch bend buttons, which allow for an instant resume to the "pitch slider assigned" pitch for the track.

### In scratch mode

In scratch mode, touching the jogs will pause the song. The jogs are very sensitive, and allow for scratching and launching tracks on a given moments when "cueing them in your headphones". Be very careful with this: never remain in scratch mode if not needed, you will touch the jogs by error and put your tracks out of sync because one has pause, or worse, produce a "blank".

### Known problems

- The pitch on the controller has a very short run. Thus, having it configured as a +10/-10 (or more) is tricky because you will get a very low pitch precision. Configuring it as +8/-8 (Mk2 style) is highly recommended
- The autolooping functions, although implemented are quite flawed. The "loop one bar", which is present since the 1.0b version, is making a loop between two bars, which are rarely fitted on real "measures". As of mixxx 1.9, there is no possibility to adjust the bars to make them fit perfectly to the tempo
- Pressing play while "cue previewing" should start the track for real, CDJ style. This is not implemented yet, and is marked as a TODO in Mixxx code, so it is unlikely to get implemented on the controller mapping side. \*NOTE: If you use the mapping included with the software, this feature is supported. Controls in this mapping are different than the community made one, so be careful.\*
- Final remark on the hardware design: be very, very careful not to press the "Load A" or "Load B" button, instead of the corresponding track's "cue" button. They are very near, the error is easy and produces the most dire effect in a party: an awful blank !

## 17.1.80 Numark Mixtrack Platinum

- [Manufacturer's product page](#)
- [Forum thread](#)

The Numark Mixtrack Platinum is a 2 channel (with 4 channel layering) entry level DJ controller with an integrated audio interface. The stand out feature of the Mixtrack Platinum is the LCD displays integrated into the jog wheels. It is a USB Audio and MIDI Class compliant device and works with Linux, macOS, and Windows.

Nuovo nella versione 2.2.

### Audio interface

Configure Mixxx's Master output for channels 1-2 and Headphones output for Channels 3-4.

The microphone input on this controller is not available to the computer through the controller's audio interface. It is mixed with the master output in hardware, so this controller's audio interface is not suitable for broadcasting or recording the inputs. If you want to use the controller for broadcasting or recording, a separate *audio interface* with a microphone input is suggested.

### Configuration Options

Configuration options can be set in the mapping. You will need to edit the values below at the very top of the JavaScript file `Numark-Mixtrack-Platinum-scripts.js` and save changes. Allowed values are "true" or "false" unless specified.

- **EnableWheel:** if true, wheel/vinyl mode will be enabled by default (defaults to true)
- **ShowTimeElapsed:** if true, time elapsed will be show by default on the displays, otherwise time remaining will be displayed (defaults to true)
- **UseManualLoopAsCue:** if true, the manual loop controls will behave as hotcues 5-8. When enabled, the normal loop control behavior can be activated using `shift+pad mode+mode` button and `pad mode+mode` to use the hotcue behavior (defaults to false)
- **UseAutoLoopAsCue:** if true, the auto loop controls will behave as hotcues 5-8. When enabled, the normal loop control behavior can be activated using `shift+pad mode+mode` button and `pad mode+mode` to use the hotcue behavior (defaults to false)
- **UseCueAsSampler:** if true, the hotcues will control sampler slots 5-8 when sampler mode is active. When enabled, the normal hotcue control behavior can be activated using `shift+pad mode+sampler` while `pad mode+sampler` will activate the special behavior (defaults to false)
- **ShiftLoadEjects:** if true, pressing shift + load will eject a track (defaults to false)

### Mapping

1. **Browse Knob:** Rotate this knob clockwise to scroll down, counter clockwise to scroll up. Press the Knob to load tracks into the inactive deck, expand entries in the library view, and select playlists and crates.

**Shift + Turn:** Page down/page up, allows you to scroll by page instead of by item.

**Shift + Push:** Focus next library pane, allows you to toggle between the left and right panes.

2. **Master Gain:** Adjusts the master volume in the software.

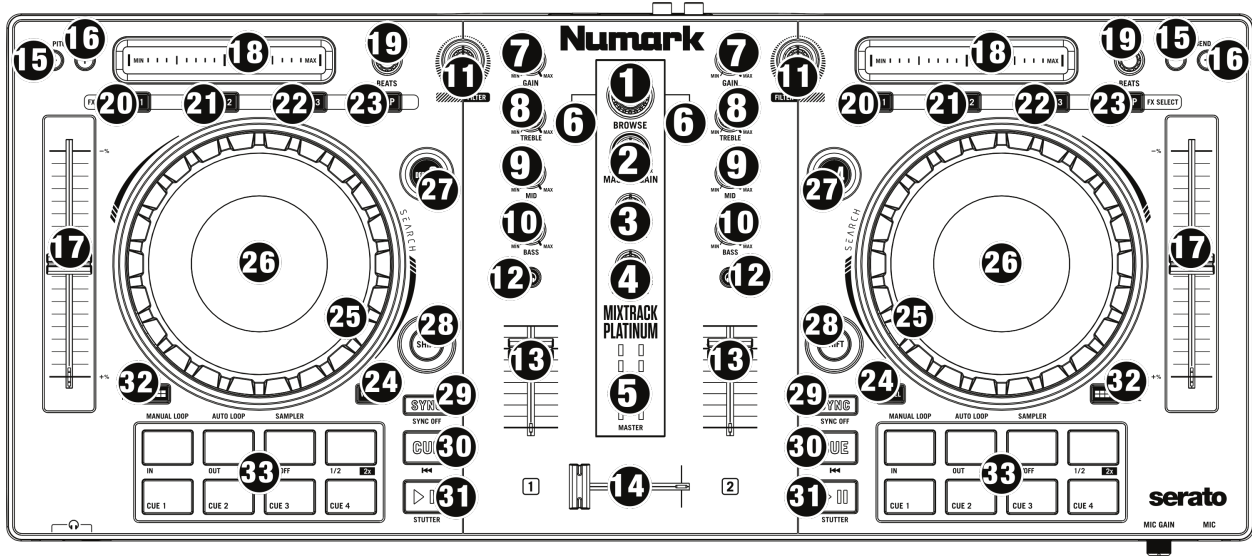

Figure32: Numark Mixtrack Platinum (schematic view)

**Note:** This control does not affect the microphone volume which is summed with the final output of the Master Gain to the Master Output. Use the Mic Gain knob to control the microphone volume.

3. **Cue Mix:** Adjusts the software’s audio output to the headphones, mixing between the cue (PFL) output and the master mix output.

4. **Cue Gain:** Adjusts the volume for headphone cueing in the software.

**Shift+Cue Gain:** adjust the volume of the first 8 sampler banks

5. **VU Meter:** Monitor the volume levels of the master output and each channel. When cue/pfl is active on ANY channel, the meter shows the mono levels each channel (left meter shows the deck on the left, right meter for the deck on the right). Otherwise the meter shows the stereo levels of the master output.

6. **Load:** Press one of these buttons while a track is selected in the library window to assign it to Deck 1 and 2 (or 3 and 4), respectively, in the software.

**Shift + Load:** Load the track and play (or if the ShiftLoadEjects option is set, eject the track)

7. **Gain Knobs:** Adjust the gain of the deck.

**Shift + Gain:** Adjust parameter 2 of the currently focused effect on this deck.

8. **High EQ Knobs:** Adjust the volume of the high frequencies of the deck.

**Shift + High:** Adjust parameter 3 of the currently focused effect on this deck.

9. **Mid EQ Knobs:** Adjust the volume of the mid frequencies of the deck.

**Shift + Mid:** Adjust parameter 4 of the currently focused effect on this deck.

10. **Low EQ Knobs:** Adjust the volume of the low frequencies of the deck.

**Shift + Low:** Adjust parameter 5 of the currently focused effect on this deck.

11. **Filter:** Adjusts the amount of the filter effect. Turning the knob left controls the low pass filter; turning it right controls the high pass filter. The effect applied here can be configured (the Quick Effect option in the Equalizer preferences).

**Shift + Filter:** With no effect focused, this controls the Superknob of the effects unit. With an effect focused, this adjusts parameter 1 of the currently focused effect on this deck.

12. **Cue/PFL/Headphones:** Sends pre-fader audio to the headphone output. If any channels have the cue button active, the VU meter will show channel output levels instead of master output levels on all decks.

13. **Volume fader:** Adjusts the volume of the deck.

14. **Crossfader:** Controls the blend between the two decks.

15-16. **Pitch Bend Down/Up:** Press and hold to momentarily reduce the speed of the track.

**Shift + Pitch Bend:** adjust the key of the playing track up or down. Press both buttons to reset the key.

**Pitch Bend Up + Pitch Bend Down:** toggle keylock

17. **Pitch Fader:** Adjust the speed of the music (activate keylock to adjust tempo without affecting pitch). Note that moving the fader down *increases* speed, as marked by the “+” at the bottom of the fader on the controller. This can be reversed in Mixxx’s preferences under Interface > Speed slider direction.

18. **Touch Strip:** Use the Touch Strip to adjust the deck’s Effect Unit Superknob. When an effect is focused, the touch strip controls that effect’s meta knob.

**Shift + Touch Strip:** search through a track’s timeline

19. **Beats Knob:** Adjusts the Dry/Wet mix of the deck’s Effect Unit.

20. **FX 1 On/Off:** Toggle FX 1 of the deck’s Effect Unit

**Shift + FX 1:** Cycle to the next effect.

**Hold + FX 1:** Enable this effect in instant mode, after the button is released the effect will be disabled again.

**Tap + FX 1:** Focus this effect to allow adjusting its metaknob with the touch strip.

21. **FX 2 On/Off:** Toggle FX 2 of the deck’s Effect Unit

**Shift + FX 2:** Cycle to the next effect.

**Hold + FX 2:** Enable this effect in instant mode, after the button is released the effect will be disabled again.

**Tap + FX 2:** Focus this effect to allow adjusting its metaknob with the touch strip.

22. **FX 3 On/Off:** Toggle FX 3 of the deck’s Effect Unit

**Shift + FX 3:** Cycle to the next effect.

**Hold + FX 3:** Enable this effect in instant mode, after the button is released the effect will be disabled again.

**Tap + FX 3:** Focus this effect to allow adjusting its metaknob with the touch strip.

23. **Tap BPM:** Press this button several times on beat to manually enter a new BPM. The software will ignore the track's BPM and follow your manually entered tempo.
24. **Wheel button:** If active you can use the platter/jog wheel to grab and move the audio, scratching the track like a vinyl record.
- Shift + Wheel:** Toggle elapsed time or time remaining on the deck's display.
25. **Platter/Jog Wheel:** If Wheel is enabled, touching the platter will result in vinyl scratching, when disabled, nothing will happen and the entire jog wheel behaves as if the side was touched.
- Touch side:** Pitch bend (nudging) if track is playing
- Shift + Touch platter:** Quickly scroll through the track
- Shift + Touch side:** Beat jump
26. **Jog Wheel Display:** The display is fully functional with this mapping. It will display the position of the spinner, play position, bpm, and keylock status.
27. **Deck Switch:** Allows switching between decks 1/3 and 2/4.
28. **Shift:** Allows alternate options to be activated for various controls.
29. **Sync:** Set the BPM of this deck to match the opposite deck. **Press:** Press once to synchronize the tempo (BPM) to that of to that of the other track
- Long Press:** Enable master sync. Press again to disable.
- Shift + Sync:** Toggle quantize mode.
30. **Cue (Transport Control):** Behavior depends on the *cue mode* set in the Mixxx preferences.
- Shift + Cue:** return the play head to the start of the track and stop the deck.
31. **Play/Pause:** Starts and stops playback.
- Shift + Play/Pause:** stutter the track from the last set cue point. If a cue point has not been set, the play head will return to the start of the track.
32. **Pad Mode:** Hold this button to see the currently selected pad mode, while holding select between Manual Loop, Auto Loop, and Sampler modes. Additionally control of hotcues 5-8 can be activated using shift+pad mode+loop mode (either manual or auto loop). Setting either of the **UseManualLoopAsCue** or **UseAutoLoopAsCue** options will reverse the selection of hotcue vs loop mode when shift is held.
- Pad Mode+Manual Loop:** set the top row of pads to manual loop control mode (see below)
- Pad Mode+Auto Loop:** set the top row of pads to auto loop/loop roll control mode (see below)
- Pad Mode+Sampler:** set the top row of pads to sampler control mode (see below)
- Shift+Pad Mode+Manual Loop:** set the top row of pads to control hotcues 5-8 (see below)
- Shift+Pad Mode+Auto Loop:** set the top row of pads to control hotcues 5-8 (see below)
- Shift+Pad Mode+Sampler:** set the bottom row of pads to control sampler banks 5-8 (see below)
33. **Performance Pads:**
- The top row of pads is for controlling loops and samples. To select a mode, hold down the Pad Mode button and press one of the upper pads. An LED under the pad section indicates the currently selected mode. See the subsections below for details about each mode.



The bottom row of pads is used to trigger hotcue points. If a hotcue point has not already been set for the loaded track, this control will mark the hotcue point. If a hotcue point has already been set, this control will jump to it.

**Shift + Hot Cue:** Deletes the assigned hotcue point

Note: the top row can be made to control hotcues 5-8 using shift+pad mode+loop mode (being Auto Loop or Manual Loop). This can also be made the default using a config option (see documentation above and below).

## Manual Loop Mode

Hold Pad Mode and press the pad marked Manual Loop (silkscreened above the pad) to assign the upper 4 pads to the functions listed below:

- **Loop In** – Sets the beginning of a loop: When assigned, the Pad LED will light blue
- **Loop Out** – Sets the end point for the loop: When assigned, the Pad LED will light blue
- **On/Off** – (De)activate the loop. If a loop has not been set, this button will have no effect.: When assigned, the Pad LED will light blue
- **Loop x1/2** – Halve the length of the loop. Press Shift + Loop x1/2 to double the length of the loop. Note that this does not update the beatloop size shown on screen.

If Manual Loop is selected with Shift and Pad Mode held down this will activate control of hotcues 5-8 on the upper row instead of the looping controls. Select Manual Loop again while holding Pad Mode to restore the default behavior. There will be no indication of which mode is selected (beyond the LEDs on the keys themselves, which will vary depending on loop and hotcue status). The **UseManualLoopAsCue** config option can be set in the mapping file (see above) to swap the default “shadow” mode of the looping controls such that hotcue control will be the default and manual loop control will be selected when Shift is used.

## Auto Loop Mode

Hold Pad Mode and press the pad marked Auto Loop to assign the upper 4 pads to the functions listed below:

\* **Auto 1:** – Sets and starts playback of a 1-beat autoloop.

- **Auto 2:** – Sets and starts playback of a 2-beat autoloop.
- **Auto 3:** – Sets and starts playback of a 4-beat autoloop.
- **Auto 4:** – Sets and starts playback of a 8-beat autoloop. \* **Shift + Auto 1:** – When held, starts a 1/16-beat loop roll.
- **Shift + Auto 2:** – When held, starts a 1/8-beat loop roll.
- **Shift + Auto 3:** – When held, starts a 1/4-beat loop roll.
- **Shift + Auto 4:** – When held, starts a 1/2-beat loop roll.

Note: loop rolls activate slip mode so the play position continues to advance normally, such that when the loop is released, play continues from the place it would have been if no loop had been activated.

If Auto Loop is selected with Shift and Pad Mode held down this will activate control of hotcues 5-8 on the upper row instead of the looping controls. Select Auto Loop again while holding Pad Mode to restore the default behavior. There will be no indication of which mode is selected (beyond the LEDs on the keys themselves, which will vary depending on loop and hotcue status). The **UseAutoLoopAsCue** config option can be set in the mapping file (see above) to swap the default “shadow” mode of the looping controls such that hotcue control will be the default and auto loop control will be selected when Shift is used.

## Sample Mode

Hold Pad Mode and press the pad marked Sampler to enter sampler mode (hold down shift as well to control slots 5-8 using the hotcue buttons). A press of any of the sample buttons will load a sample if the sampler is not loaded. Shift + sample pad will unload a sample if it is not playing. Pressing a pad when a sample is loaded will play the sample, pressing shift + sample pad while a sample is playing will stop it.

Use **shift+cue gain** to adjust the volume of the sampler. When switching to the pad mode to sampler, hold down shift to control slots 5-8 using the hotcue buttons.

Note: the 8 sample slots on each deck all control the same 8 slots in Mixxx no matter which deck the sampler is active on. This is because the controller sends the same MIDI codes for button presses on each side, so there is no way for Mixxx to tell whether a sampler button was pressed on the left or right side of the controller.

### 17.1.81 Numark Mixtrack Pro

This is the same as the *Numark Mixtrack* with the addition of an integrated sound card. This product has been discontinued and succeeded by the *Numark Mixtrack Pro 3*.

- [Manufacturer's product page](#)

Nuovo nella versione 1.8.2.

## Mapping Description

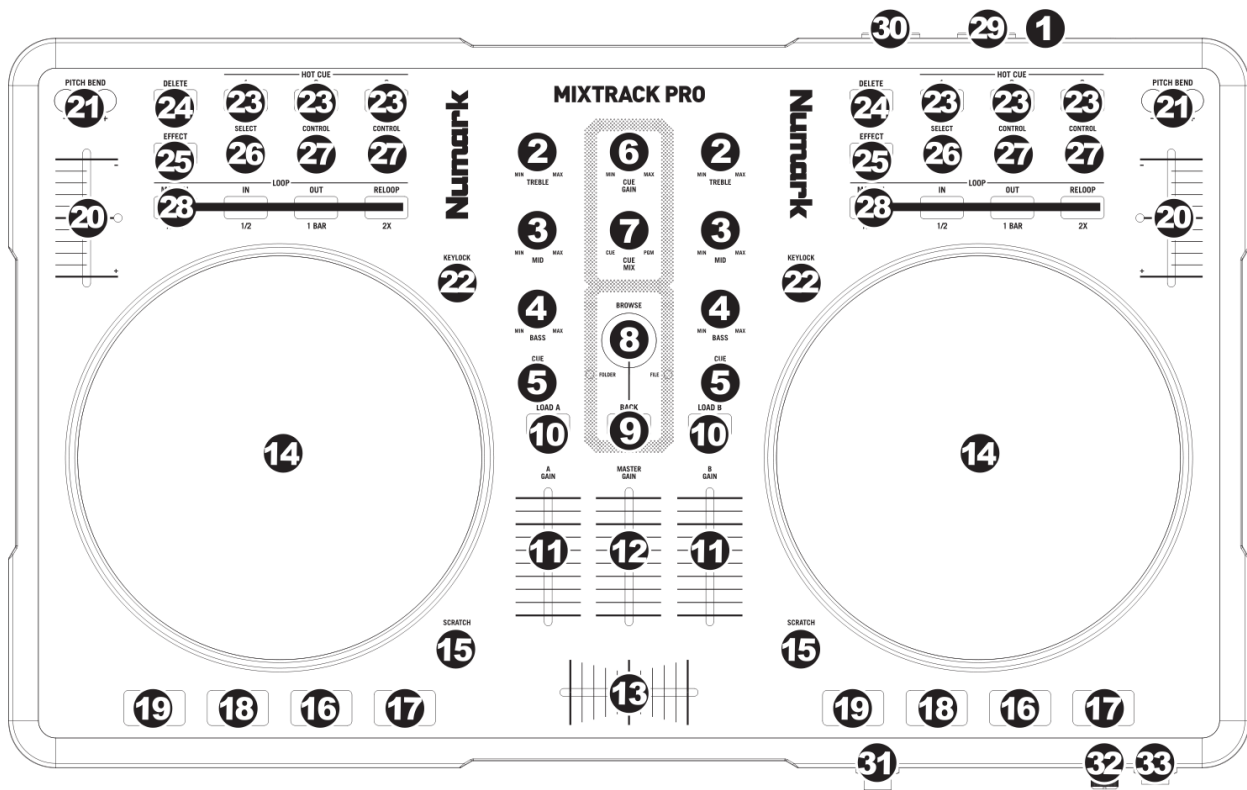

Figure33: Numark Mixtrack Pro (schematic view)

1. **USB:** This USB connection sends and receives control information to/from a connected computer.

2. **CHANNEL TREBLE:** Adjusts the high (treble) frequencies of the corresponding channel.
3. **CHANNEL MID:** Adjusts the mid-range frequencies of the corresponding channel.
4. **CHANNEL BASS:** Adjusts the low (bass) frequencies of the corresponding channel.
5. **CUE:** Sends pre-fader audio to the Cue Channel for headphone monitoring.
6. **CUE GAIN:** Adjusts the audio level of the Cue channel.
7. **CUE MIX:** Turn to mix between Cue and Program in the Headphone channel. When all the way to the left, only channels routed to CUE will be heard. When all the way right, only the Program mix will be heard.
8. **BROWSE KNOB:** Turn this knob to scroll through lists of tracks / library. When a file is selected, press the knob to load the currently highlighted song into the first stopped deck.
9. **BACK:** This button will switch the Browse Knob to scroll into the track list (FILE LED will illuminate) or into the library section (FOLDER LED will illuminate).
10. **LOAD A / LOAD B:** Press one of these buttons while a track is selected to assign it to Deck A or Deck B, respectively. **\*Only if the track is paused. Put the pitch in 0% at load (without mattering where the slider is).**
11. **CHANNEL FADER:** Adjusts the audio level on the corresponding channel.
12. **MASTER FADER:** Adjusts the output volume of the Program mix.
13. **CROSSFADER:** Blends audio playing between Decks A and B. Sliding this to the left plays Deck A and sliding to the right plays Deck B.
14. **JOG WHEEL:** When the deck is playing, the JOG WHEEL will bend the track's pitch. When the SCRATCH button is on, touching the top of the JOG WHEEL will scratch the selected track (**can do backspin effect**), and touching the border of the JOG WHEEL will bend the track's pitch. When the deck is not playing, rotating the JOG WHEEL will scan through the track.
15. **SCRATCH:** Turns Scratch Mode on or off. If Scratch Mode is on, the button will light up and the JOG WHEEL will scratch like a turntable when you spin it.
16. **PLAY / PAUSE:** Starts or resumes playback if the Deck is paused. Pauses playback if the Deck is playing. LED ON when playing. LED OFF when stopped.
17. **STUTTER:** Adjust BeatGrid in the correct place (useful to sync well). **\*LED Blink at each Beat of the grid.**
18. **CUE:** The CUE button will return and pause the track at the last set cue point. For temporary play of the cue point, you can hold down the CUE button. The track will play for as long as the button is held down and will return to the cue point once it has been released (Until it has been pressed PLAY before release CUE, then playback will continue). LED ON when stopped. LED OFF when playing. **\*LED Blink at each Beat in the last 30 seconds of song. \*Don't set Cue accidentally at the end of the song (return to the latest cue).**
19. **SYNC:** Automatically matches the corresponding Deck's tempo and phase with the other Deck. **\*If the other deck is stopped, only sync tempo (not phase).** **\*LED Blink at Clip Gain (Peak indicator).** **\*\*\*Pressing DELETE\*\*before SYNC: Set Pitch to 0%.**
20. **PITCH FADER:** Controls the track's playback speed. An LED next to the fader will light up when set at 0%. **\* Pitch slide are inverted, to match with the screen (Up: +, Down: -, otherwise is very confusing).** **\*\*\* Soft-takeover to prevent sudden wide parameter changes\*\*when the on-screen control diverges from a hardware control. The control will have no effect until the position is close to that of the software, at which point it will take over and operate as usual.**
21. **PITCH BEND ( + / - ):**  Press or hold down either of these buttons to temporarily adjust the track's playback speed. When released, the track playback will return to the speed designated by the PITCH FADER.
22. **KEYLOCK:** This feature allows you to change the speed of the song without changing the key.

23. **HOT CUE BUTTONS (1-3):** Assigns a Cue Point or returns the track to that Cue Point. When a HOT CUE BUTTON is unlit, you can assign a Cue Point by pressing it at the desired point in your track. Once it is assigned, the HOT CUE BUTTON will light. To return to that Cue Point, simply press it. **\*Pressing DELETE** before HOT CUE: Clear Hotcue.
24. **DELETE:** Press this to enable second functions to some buttons (LED on). On having pressed another button, it is deactivated and LED turn off. Combinations: **Delete + EFFECT:** Brake Effect (maintain pressed). Flanger Delay (Left. EFFECT CONTROL): Adjust the speed of Brake. **Delete + HOTCUE:** Clear Hotcue. **Delete + RELOOP:** Clear Loop. **Delete + MANUAL:** Set Quantize ON (for best manual loop) or OFF. **Delete + SYNC:** Set Pitch to 0%.
25. **EFFECT:** Activate / deactivate Flanger. SELECT modify the Depth and LEFT. EFFECT CONTROL change the Delay. **\*Pressing DELETE** before EFFECT: Brake (maintain pressed). Adjust Speed with Flanger Delay (Left. EFFECT CONTROL).
26. **EFFECT SELECT:** Modify the Depth of Flanger effect, which will be displayed in the software.
27. **LEFT EFFECT CONTROL:** Modify the Depth of Flanger effect, which will be displayed in the software. **\*Used for change the speed of Brake effect too.** **RIGHT EFFECT CONTROL:** Gain control of the deck (up to clip).
28. **MODE:** Press this to switch between Autoloop Mode and Manual Mode, which changes the functions of the LOOP CONTROL buttons. **\*Pressing DELETE** before MODE: Set Quantize ON (for best manual loop), or OFF. **Autoloop Mode (LED ON):** • 1/2 X: Press this to halve the length of the loop. • 1 BAR: Press this to set a 4 beat loop automatically and enable it (LED ON). **Press again to exit loop.** • 2 X: Press this to double the length of the loop. **Manual Mode (LED OFF):** • IN: Press this to set a “Loop In” point where your loop will begin (LED ON). • OUT: Press this to set a “Loop Out” point where your loop will end, and enable it (LED ON). • RELOOP: If the Deck is already looping when you press it (LED ON), exit loop. If not, jump to the start of the loop and enable it. (If no loop is set, nothing will happen.) **\*Pressing DELETE** before RELOOP: Clear Loop.
29. **OUTPUT 1 (RCA):** This stereo RCA connection will output the Master Mix from your computer. Please use a stereo RCA cable to connect this output to a powered speaker or amplifier system.
30. **OUTPUT 2 (RCA):** This stereo RCA connection will output the Cue Channel from your computer for monitoring purposes. Please note that the Cue Channel is also output through the HEADPHONES output on the front panel.
31. **HEADPHONES:** This stereo 1/4» output will output the signal being routed to the Cue Channel.
32. **MIC GAIN:** This knob controls the microphone level being sent to the Master Mix.
33. **MIC THROUGH:** This is a 1/4» microphone input. The signal from this input will be sent directly to the Master Mix.

### Known problems

- The pitch on the controller has a very short run. Thus, having it configured as a +10/-10 (or more) is tricky because you will get a very low pitch precision. Configuring it as +8/-8 (Mk2 style) is highly recommended.
- Each slide/knob needs to be moved on Mixxx startup to match levels with the Mixxx UI.

### 17.1.82 Numark Mixtrack (Pro) 3

- [Manufacturer's product page](#)
- [Manufacturer's User Manual](#)
- [Forum thread](#)

The Numark Mixtrack 3 and Numark Mixtrack Pro 3 are the same controller except that the Pro version has an integrated 4 channel output sound card and costs \$50 more. If you use the non-Pro version, you would need a *splitter cable* or *separate audio interface* to be able to preview tracks in headphones.

The microphone input on the Pro version is not available to the computer through the controller's sound card. It is mixed with the master output in hardware, so this controller's sound card is not suitable for broadcasting or recording the inputs. If you want to use the controller for broadcasting or recording, getting the non-Pro version with a separate *audio interface* with a microphone input is suggested.

Nuovo nella versione 2.1.

#### Configuration options

Configuration options can be set in the mapping. You will need to edit the values below at the very top of the JavaScript file "Numark-Mixtrack-3-scripts.js" and save changes. Allowed values are "**true**" or "**false**" unless specified.

- **TrackEndWarning**: whether the Wheel button flashes near the end of a track
- **iCutEnabled**: whether to enable iCut with the jog wheel. See *#platter/jog wheel* section for details
- **fastSeekEnabled**: whether to enable fast seeking with the jog wheel. See *#platter/jog wheel* section for details
- **smartPFL**: When the Load button is used, the Cue/PFL button is automatically activated on the deck being loaded and deactivated on the other deck
- **beatlooprollActivate**: Use beatlooproll (slip mode loop) instead of beatloop command when using pads in Autoloop mode
- **DarkMetalSkin**: Specify if Dark Metal skin is used for your installation. This is required in order for Expand Library feature to work properly.
- **FXMode**: Select FX Mode based on skin used:
  - value "1": (Deere skin): Each deck is assigned its own Effect Unit with 3 effects per deck (e.g. Deck 1 = Effect Unit 1, Deck 2 = Effect Unit 2, etc...)
  - value "2": (other skins): FX button 1 = Effect Unit 1, Effect 1, FX Button 2 = Effect Unit 2, Effect 1, FX button 3 = Effect Unit 3, Effect 1. Effect settings are shared by each deck.
- **PitchBendOnWheelOff**: allow nudge with wheel when wheel is not active.
- **noPlayOnSyncDoublePress**: Specify if Play is disabled on Sync button Double Press.
- **ShiftFilterFX4**: Specify Shift+Filter control behavior - FX parameter 4 (true) or Channel Gain (false)

## Mapping Description

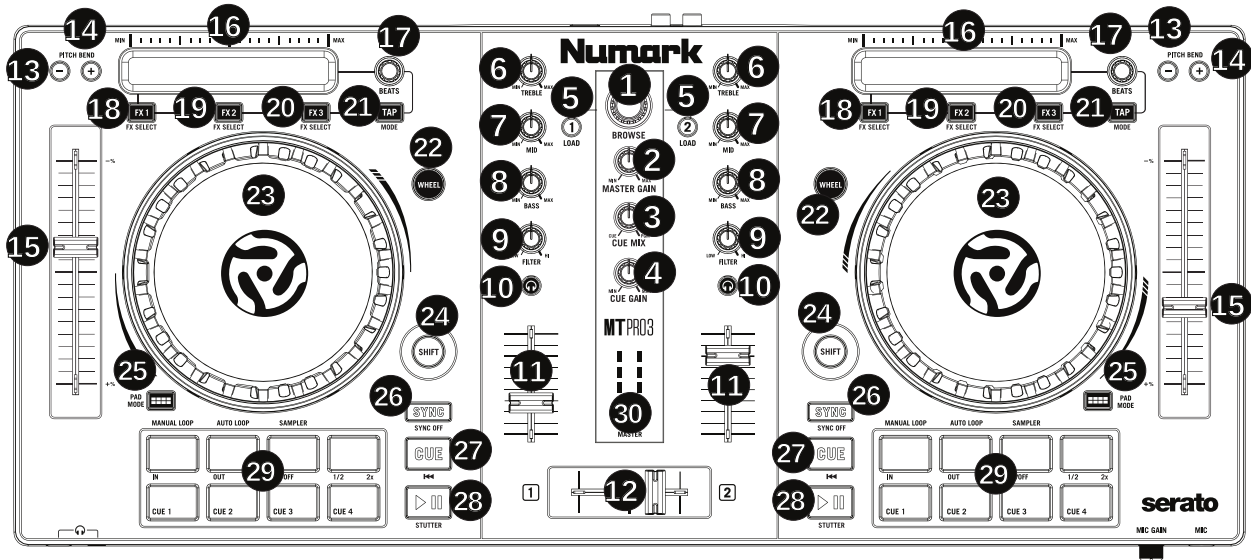

Figure34: Numark Mixtrack (Pro) 3 (schematic view)

### 1. Browser Knob

Rotate this knob to cycle through tracks in main library window. Press the Knob to expand library view.  
**SHIFT + Turn:** allows selecting Play Lists and side navigation bar items.  
**SHIFT + Push:** opens / closes selected side navigation bar item.

### 2. Master Gain

Adjusts the master volume in the software.

**Note:** This control does not affect the microphone volume which is summed with the final output of the Master Gain to the Master Output. Use the Mic Gain knob to control the microphone volume.

### 3. Cue Mix

Adjusts the software's audio output to the headphones, mixing between the cue (PFL) output and the master mix output.

### 4. Cue Gain

Adjusts the volume for headphone cueing in the software.

### 5. Load

Press one of these buttons while a track is selected in the library window to assign it to Deck 1 and 2, respectively, in the software.

SHIFT + LOAD: Activates Fader Start mode for the corresponding (PFL Button is then blinking). Fader start guide: In fader start mode, not only you can press the play/pause button to play/pause the track, but if you move up the level fader (the volume fader if you prefer) of the deck, the track will be played and if you close it to zero, the track will be paused.

#### **Configurable option:**

If the *smartPFL option* is set to true, the Cue/PFL button is automatically activated on the deck being loaded and deactivated on the other deck.

### 6. High EQ Knobs

Adjust High frequencies of the deck

SHIFT + HIGH: Adjust parameter 1 of the currently focused effect on this deck.

### 7. Mid EQ Knobs

Adjust Mid frequencies of the deck

SHIFT + MID: Adjust parameter 2 of the currently focused effect on this deck.

### 8 Low EQ Knobs

Adjust Low frequencies of the deck

SHIFT + LOW: Adjust parameter 3 of the currently focused effect on this deck.

### 9. Filter

Adjusts the amount of the filter effect. Turning the knob left controls the low pass filter; turning it right controls the high pass filter.

SHIFT + FILTER: Adjust parameter 4 of the currently focused effect on this deck.

If effect is unfocused then;

SHIFT + FILTER Adjust the gain of the deck.

## 10. Cue/PFL/Headphones

Sends pre-fader audio to the headphone output

SHIFT + CUE/PFL: Toggle quantize mode

## 11. Volume fader

Adjusts the volume of the deck

## 12. Crossfader

Controls the blend between the two decks

## 13-14. Pitch Bend Down/Up

Press and hold to momentarily reduce the speed of the track.

SHIFT + **PITCH BEND** -/+ : Jump 1 beat backward/forward

- If loop is activated, move loop by beatjump amount instead.

## 15. Pitch Fader

Adjust the speed of the music (activate keylock to adjust tempo without affecting pitch). Note that moving the fader down *increases* speed, as marked by the “+” at the bottom of the fader on the controller. This can be reversed in Mixxx’s preferences under Interface > Speed slider direction

## 16. Touch Strip

Use the Touch Strip to adjust the deck’s Effect Unit Superknob. If Effects are assigned to Instant FX , they will be enabled instantly on touch, and disabled on finger lift.

SHIFT + **Touch Strip**: search through a track’s timeline

## 17. Beats Multiplier

Adjusts the Dry/Wet mix of the deck’s Effect Unit

TAP + BEATS: Moves the beat grid left (turn counterclockwise) or right (turn clockwise)

SHIFT + BEATS: Adjust beatjump amount

PADMODE + BEATS: Adjust Sampler Volume. Left beat knob will adjust Samplers 1-4; Right knob will adjust Samplers 5-8



## 18. FX 1 On/Off

Turns FX1 on and off

SHIFT + FX1: Select from the list of available effects for the respective effect.

PADMODE + FX1: Assign / unassign FX 1 to Instant FX. When assigned to Instant FX, the FX is instantly activated by touching the Strip and stopped when finger is lifted.

TAP + FX1: Focus this effect to allow adjusting its metaknob with the touch strip.

## 19. FX 2 On/Off

Turns FX2 on and off

SHIFT + FX2: Select from the list of available effects for the respective effect.

PADMODE + FX2: Assign / unassign FX 1 to Instant FX. When assigned to Instant FX, the FX is instantly activated by touching the Strip and stopped when finger is lifted.

TAP + FX2: Focus this effect to allow adjusting its metaknob with the touch strip.

## 20. FX 3 On/Off

Turns FX3 on and off

SHIFT + FX3: Select from the list of available effects for the respective effect.

PADMODE + FX3: Assign / unassign FX 1 to Instant FX. When assigned to Instant FX, the FX is instantly activated by touching the Strip and stopped when finger is lifted.

TAP + FX3: Focus this effect to allow adjusting its metaknob with the touch strip.

## 21. Tap BPM

Press this 8 or more times on beat to manually enter a new BPM. The software will ignore the track's BPM and follow your manually entered tempo.

SHIFT + TAP: Toggles deck between deck 1-3 (left side) or deck 2-4 (right side). TAP LED will be RED when deck 3 is active (Left Tap) or deck 4 is active (Right Tap)

TAP + HOTCUE 1: Activates Brake effect

TAP + HOTCUE 2: Activates Spinback effect

## 22. Wheel button

Activate this button to use the platter/jog wheel to grab and move the audio, scratching the track like a vinyl record.

SHIFT + WHEEL: Toggle slip mode on/off

## 23. Platter/Jog Wheel

**Touch side:** Pitch bend (nudging) if track is playing (Wheel On (always) & Wheel Off - if *PitchBendOnWheelOff* configuration option is true) and / track positioning (Wheel On)

**WHEEL On + Touch platter:** scratching: touch the platter and move it

**WHEEL Off + Touch platter:** If track is not playing, allows positioning the track

**SHIFT + WHEEL Off + Touch platter:** fast seek through track

**SHIFT + WHEEL On + Touch platter:** iCut mode: simulates a scratch routine with the jog wheel. When the jog wheel is turned back, the crossfader closes; when the jog wheel is turned forward the crossfader will open. As a visual reference, TAP LED and Wheel button LED will be ON.

**Configuration Options:** The *iCutEnabled* and *fastSeekEnabled* options can be used to turn off iCut and fast seeking. These options may be helpful to avoid accidentally using these features when touching the platter with shift lock on.

## 24. Shift

Allows multiple control commands to be triggered when pressed first along with other buttons

## 25. Pad Mode

This is used to change the operation mode of the *top 4 performance pads*. Pressing this button will light the pad indicating the currently active mode (Manual Loop, Auto Loop or Sampler).

## 26. Sync

Enables BPM syncing between decks.

**Short Press:** Press once to synchronize the tempo (BPM) to that of to that of the other track

**Double Press:** press twice QUICKLY to play the track immediately synchronized to the tempo (BPM) and to the phase of the other track, if the track was paused

**Long Press (Sync Lock):** Hold for at least half of a second to enable sync lock for this deck. Decks with sync locked will all play at the same tempo, and decks that also have quantize enabled will always have their beats lined up. If the Sync Lock was previously activated, it just deactivates it regardless of the Short press/Double Press

SHIFT + SYNC: Toggle Key Lock

**Configuration Options:** The *noPlayOnSyncDoublePress* option can be used to turn off Play on Sync Double Press.

## 27. Cue (Transport Control)

Behavior depends on the *cue mode* set in the Mixxx preferences.

SHIFT + CUE: Return the play head to the start of the track.

## 28. Play/Pause

Starts and suspends playback. If no track is loaded, loads the selected track (if any) and play.

SHIFT + PLAY/PAUSE: Stutter the track from the last set cue point. If a cue point has not been set, the play head will return to the start of the track.

## 29. Performance Pads

The top row of pads is for controlling loops and samples. To select a mode, hold down the Pad Mode button and press one of the upper pads. An LED under the pad section indicates the currently selected mode. See the subsections below for details about each mode.

The bottom row of pads is used to trigger hotcue points. If a hotcue point has not already been set for the loaded track, this control will mark the hotcue point. If a hotcue point has already been set, this control will jump to it.

SHIFT + HOTCUE: Deletes the assigned hotcue point

### Manual Loop Mode

Hold PADMODE and press the pad marked Manual Loop (silkscreened above the pad) to assign the lower 4 pads to the functions listed below:

- **Loop In** – Sets the beginning of a loop: When assigned, the Pad LED will light blue
- **Loop Out** – Sets the end point for the loop: When assigned, the Pad LED will light blue
- **On/Off** – (De)activate the loop. If a loop has not been set, this button will have no effect.: When assigned, the Pad LED will light blue
- **Loop x1/2** – Halve the length of the loop. Press SHIFT + **Loop x1/2** to double the length of the loop. x1/2 button is disabled unless the corresponding deck is set to be quantized

### Auto Loop Mode

Hold Pad Mode and press the pad marked Autoloop to assign the lower 4 pads to the functions listed below: When assigned, the respective Pad LED will blink Yellow

- **Auto 1** – Sets and starts playback of a 2-beat autoloop.
- **Auto 2** – Sets and starts playback of a 4-beat autoloop.
- **Auto 3** – Sets and starts playback of a 8-beat autoloop.
- **Auto 4** – Sets and starts playback of a 16-beat autoloop.
- SHIFT + **Auto 1** – Sets and starts playback of a 1/8-beat autoloop.

- **SHIFT + Auto 2** – Sets and starts playback of a 1/4-beat autoloop.
- **SHIFT + Auto 3** – Sets and starts playback of a 1/2-beat autoloop.
- **SHIFT + Auto 4** – Sets and starts playback of a 1-beat autoloop.

If the pad is held down more than .5 second (Long Press), the Autoloop will be disabled once pad is released. On Short Press, the pad will behave as a normal button (ON on first press, OFF on second press)

## Sample Mode

Hold Pad Mode and press the pad marked Sampler to assign the lower 4 pads to the functions listed below. When assigned, the respective Pad LED will blink Purple

Shift + Sample X will play loaded sample, but with Sampler unit Sync disabled

- **Deck 1 - Sample 1** – Plays the sample assigned to Sample Pad 1 with the unit Sync activated.
- **Deck 1 - Sample 2** – Plays the sample assigned to Sample Pad 2 with the unit Sync activated.
- **Deck 1 - Sample 3** – Plays the sample assigned to Sample Pad 3 with the unit Sync activated.
- **Deck 1 - Sample 4** – Plays the sample assigned to Sample Pad 4 with the unit Sync activated.
- **Deck 2 - Sample 1** – Plays the sample assigned to Sample Pad 5 with the unit Sync activated.
- **Deck 2 - Sample 2** – Plays the sample assigned to Sample Pad 6 with the unit Sync activated.
- **Deck 2 - Sample 3** – Plays the sample assigned to Sample Pad 7 with the unit Sync activated.
- **Deck 2 - Sample 4** – Plays the sample assigned to Sample Pad 8 with the unit Sync activated.

If the pad is held down more than .5 second (Long Press), the sampler will be disabled once pad is released. On Short Press, the pad will behave as a normal button (ON on first press, OFF on second press)

- Load sample by selecting track and pressing **Sample X**
- Pressing sample button when sample is already playing goes back to cue and plays
- Shift + sample to stop sample
- Eject sample by TAP + **Sample X**

## 30. Master Output LEDs

Displays the audio level going to the Master Output.

### 17.1.83 Numark Mixtrack Pro FX

[Manufacturer's product page](#) · [Manufacturer's user manual](#) · [Forum thread](#)

Nuovo nella versione 2.3.1.

## Overview

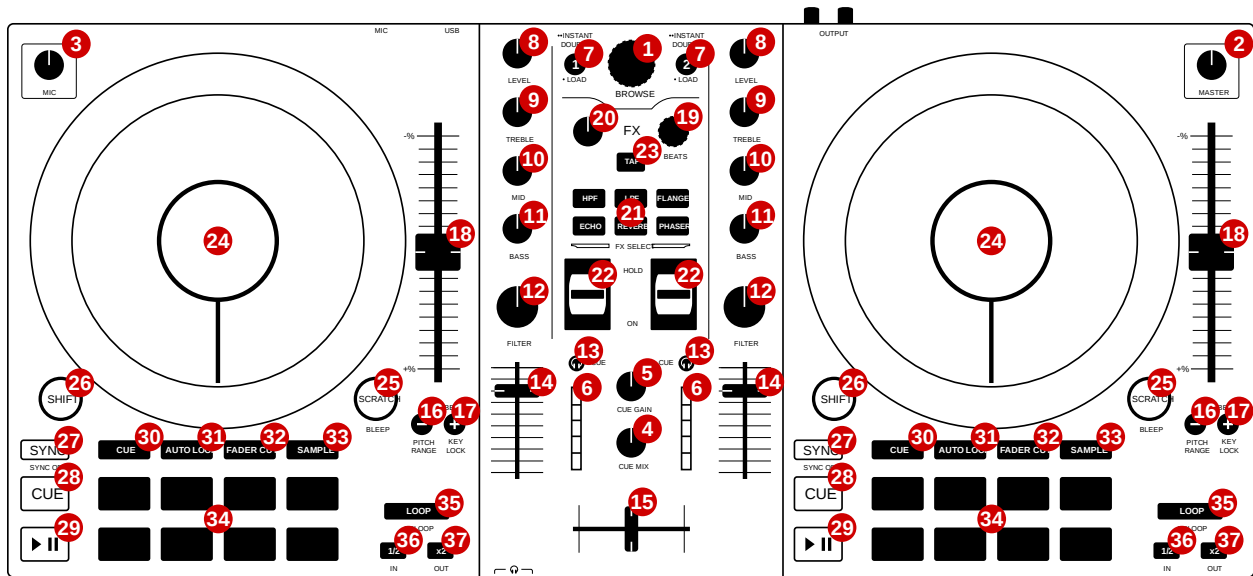

See the tables below for controls descriptions.

## Misc

| #  | Name                    | Function   |
|----|-------------------------|--|
| 1  | BROWSE (rotate)         | Browse library   |
| 1  | SHIFT + BROWSE (rotate) | Zoom in/out <i>waveform summary</i>  |
| 1  | BROWSE (press)          | Switch between tree and track list   |
| 1  | SHIFT + BROWSE (press)  | Select item (collapse/extend tree branch or load track)  |
| 2  | MASTER                  | Adjust the volume level of <i>master output</i> . Does not affect the microphone volume (adjusted separately with the MIC knob)  |
| 3  | MIC                     | Adjust the volume level of microphone input. Note that the microphone input is mixed in hardware, so the corresponding <i>GUI</i> knob does not reflect the hardware knob state. |
| 4  | CUE MIX                 | <i>Head/mix knob</i> . Adjust the audio output to the headphones, mixing between the cue output and the main mix output  |
| 5  | CUE GAIN                | Adjust the headphone volume  |
| 15 | Crossfader              | Controls the mix between the two decks   |
| 23 | BPM                     | Tap repeatedly to enter a new <i>BPM</i> on both decks   |

## Deck

Each of those controls exists in both *decks* and affects only the corresponding deck.

| #  | Name                                   | Function   |
|----|--|--|
| 6  | Main level meter                       | Displays the audio level going to the main output  |
| 7  | LOAD                                   | Load selected track  |
| 7  | .. INSTANT DOUBLES<br>(2x LOAD)        | Load track from the opposite deck and seek to the same position. Deck cloning must be enabled in Mixxx settings (Settings -> Preferences -> Decks -> Double-press Load button to clone playing track). |
| 8  | LEVEL                                  | Adjust the pre-fader, pre-EQ audio level   |
| 9  | TREBLE                                 | Adjust high frequencies  |
| 10 | MID                                    | Adjust middle frequencies  |
| 11 | BASS                                   | Adjust low frequencies   |
| 12 | FILTER                                 | Adjust the filter effect   |
| 13 | CUE                                    | <i>Headphone button</i> . Toggle sending channel to the cue (headphone) channel  |
| 14 | Channel fader                          | Adjust volume level  |
| 16 | PITCH BEND - (hold)                    | Temporarily reduce the speed of the track  |
| 16 | PITCH RANGE<br>(SHIFT + PITCH BEND - ) | Change pitch range. Ranges are configurable in the script file, see <i>Adjustable values</i> section.  |
| 17 | PITCH BEND + (hold)                    | Temporarily increase the speed of the track  |
| 17 | KEYLOCK<br>(SHIFT + PITCH BEND +)      | Toggle <i>key lock</i>   |
| 18 | Pitch fader                            | Adjust the speed of the track  |
| 24 | Jog wheel (top)                        | If scratch mode is enabled (see the SCRATCH button below): scratch<br>If scratch mode is disabled: pitch bend<br>The behavior of jogwheel can be fine-tuned, see the <i>Adjustable values</i> section. |
| 24 | Jog wheel (edge)                       | <i>Pitch bend</i>  |
| 24 | SHIFT + jog wheel                      | Seek track   |
| 25 | SCRATCH                                | Toggle scratch mode. Enabled by default.   |
| 25 | BLEEP<br>(SHIFT + SCRATCH)<br>(hold)   | Play the track in reverse, then release to continue playback from a point where the track would have been if it had not been reversed  |
| 26 | SHIFT                                  | Hold and then manipulate other controls to activate their secondary functions  |
| 27 | SYNC                                   | If sync lock is disabled: set BPM to the other deck's BPM<br>If sync lock is enabled: disable sync lock  |
| 27 | SYNC (hold, then release)              | Enable <i>sync lock</i>  |
| 27 | SYNC OFF<br>(SHIFT + SYNC)             | Toggle <i>quantization</i>   |
| 28 | CUE                                    | If track is playing: stops the track and resets position to the main cue point<br>If playback is stopped: sets the main cue point  |
| 28 | CUE (hold)                             | Play the track from main cue point, release to stop playback and return to the main cue point. Playback must be initially stopped on main cue point.   |
| 28 | SHIFT + CUE                            | Stop the playback and return to the beginning of the track   |
| 29 | Play/Pause                             | Play/pause playback  |
| 29 | SHIFT + Play/Pause                     | Toggle reverse playback  |
| 35 | LOOP                                   | If loop is disabled: enable loop, starting at current position<br>If loop is enabled: disable loop   |

continues on next page

Table 8 – continua dalla pagina precedente

| #  | Name                     | Function   |
|----|--------------------------|--|
| 35 | RELOOP<br>(SHIFT + LOOP) | If loop is enabled: jump to loop IN point and stop playback<br>If loop is disabled: enable loop, without moving it |
| 36 | 1/2                      | Decrease loop size by half   |
| 36 | IN<br>(SHIFT + 1/2)      | Set the loop IN point  |
| 37 | x2                       | Double the loop size   |
| 37 | OUT<br>(SHIFT + x2)      | Set the loop OUT point   |

**Suggerimento:** The actual behavior of CUE and Play/Pause buttons depends on Mixxx settings. See *The Mixxx User Interface* for more info.

## FX

| #  | Name               | Function  |
|----|--------------------|---|
| 19 | BEATS              | Adjust FX param 1 of Effect 1 on Effect Unit 1 and 2        |
| 19 | SHIFT + BEATS      | Adjust FX param 2 of Effect 1 on Effect Unit 1 and 2        |
| 20 | Dry/Wet knob       | Adjust the Dry/Wet rate of Effect Unit 1 and 2              |
| 21 | FX select buttons  | See below   |
| 22 | FX toggle switches | Toggle Effect 1 on Effect Unit corresponding to deck number |

FX select buttons have different functions than what is printed on them. Below is the original layout (not used), and two tables presenting button functions (and SHIFT + buttons functions).

Table9: Original layout of FX select buttons (**not used**)

|      |        |         |
|------|--------|---------|
| HPF  | LPF    | FLANGER |
| ECHO | REVERB | PHASER  |

Table10: FX select/bonus functions buttons

|                                    |                                  |                                    |
|------------------------------------|----------------------------------|------------------------------------|
| Effect Unit 1 Effect 1 previous FX | Adjust <i>beatgrid</i> on deck 1 | Effect Unit 2 Effect 1 previous FX |
| Effect Unit 1 Effect 1 next FX     | Adjust <i>beatgrid</i> on deck 2 | Effect Unit 2 Effect 1 next FX     |

Table11: FX select/bonus functions buttons (SHIFT)

|                      |   |                      |
|----------------------|---|----------------------|
| Pitch up on deck 1   | – | Pitch up on deck 2   |
| Pitch down on deck 1 | – | Pitch down on deck 2 |

Pitch up/down buttons change pitch by one semitone.

**Suggerimento:** For more info about Effect Units see *Effetti*.

## Pads

The 8 pads in each deck have multiple functions, depending on the selected *pad mode*. Default pad mode is *hotcues*. Current mode is selected by pressing one of the buttons above the pads. The button for currently active pad mode is lit up (or blinking, when secondary pad mode is selected - secondary pad modes are: beatjump and sampler 2).

Pads support secondary (shift) actions in most pad modes. 4 bottom pads with «special» functions printed on them (STUTTER, etc.) act the same as the top 4 pads, i.e. don't perform any special functions.

| #  | Name                     | Function  |
|----|--------------------------|---|
| 30 | CUE                      | Change pad mode to <i>hotcues</i> .<br><b>Pad press</b> : set hotcue if not set. If set, go to hotcue position and start playback<br><b>SHIFT + pad press</b> : remove hotcue (if set)<br>Pad lights indicate if a particular hotcue is set or not.   |
| 30 | SHIFT + CUE              | Change pad mode to beatjump.<br><b>Pad press</b> : beatjump forwards<br><b>SHIFT + pad press</b> : beatjump backwards<br>If loop is active, loop is moved forwards/backwards instead.<br>Default beatjump values are: 1/16, 1/8, 1/4, 1/2, 1, 2, value set in Mixxx GUI (4 by default), 8. Values can be adjusted, see the <i>Adjustable values</i> section.                  |
| 31 | AUTO LOOP                | Change pad mode to auto-loop.<br><b>Pad press</b> : activate auto-loop<br><b>SHIFT + pad press (hold)</b> : activate beatlooproll. When released, playback will resume where the track would have been if it had not entered the loop.<br>Default auto-loop sizes are: 1/16, 1/8, 1/4, 1/2, 1, 2, 4, 8. Loop sizes can be adjusted, see the <i>Adjustable values</i> section. |
| 32 | FADER CUTS               | Change pad mode to fader cuts<br>This pad mode emulates rapid crossfader movements.<br><b>Pad press (hold)</b> : activate a fader cut. The crossfader will rapidly move in one of the 8 available patterns. The crossfader will return to the position of hardware crossfader after the pad is released.<br>Note: this function is controlled by the hardware or firmware     |
| 33 | SAMPLE                   | Change pad mode to sampler 1 (samples 1-8)<br><b>Pad press</b> : play a sample<br><b>SHIFT + pad press</b> : stop sample playback   |
| 33 | SHIFT + SAMPLE           | Change pad mode to sampler 2 (samples 9-16)   |
| 34 | Performance pads         | Various functions, depending on selected pad mode   |
| 34 | SHIFT + Performance pads | Various functions, depending on selected pad mode   |



## Adjustable values

There are a few configurable values at the top of the script (`Numark-Mixtrack-Pro-FX-scripts.js`).

| Variable              | Default value  | Description   |
|-----------------------|--|---|
| pitchRange            | [0.08, 0.16, 1]  | For adjusting the range of pitch fader. Pressing PITCH RANGE (SHIFT + PITCH BEND -) cycles through available values. Number of values in the array can be changed without further script modifications. Note that the default (first) pitch range must be also selected independently in Mixxx settings (Settings -> Preferences -> Decks -> Slider range). |
| waveformsSynced       | true   | This variable should reflect the corresponding Mixxx option (Settings -> Preferences -> Waveforms -> Synchronize zoom level across all waveforms). This affects waveform summary zooming.   |
| jogScratchSensitivity | 1024   | Scratching sensitivity  |
| jogScratchAlpha       | 1  | For controlling the alpha-beta filter used in scratching  |
| jogScratchBeta        | 132  | For controlling the alpha-beta filter used in scratching  |
| jogPitchSensitivity   | 10   | Jogwheel pitch bend sensitivity   |
| jogSeekSensitivity    | -10000   | Jogwheel seek sensitivity   |
| enableBlink           | true   | Enable blinking of pad mode buttons when in secondary mode (beatjump or sampler 2)  |
| blinkDelay            | 700  | Blinking frequency of pad mode buttons when in secondary mode (in ms)   |
| autoLoopSizes         | [«0.0625», «0.125», «0.25», «0.5», «1», «2», «4», «8»]       | Loop sizes for the auto-loop pad mode, each value corresponds to one of the pads.   |
| beatJumpValues        | [«0.0625_», «0.125_», «0.25_», «0.5_», «1_», «2_», «», «8_»] | Beatjump values for the beatjump pad mode, each value corresponds to one of the pads. The empty value («») means the value set in Mixxx (4 by default). Underscores (_) are needed because of that control, which has one underscore in the name, as opposed to beatjump controls with predetermined values which have two underscores.                     |

**Suggestion:** See [here](#) for more info about constants used in scratching.

## Notes

- Pressing either SHIFT button will cause both decks to shift (e.g. when pressing SHIFT on deck 1 and then some control on deck 2, the secondary function will be executed). This approach was chosen to be consistent with the behavior of hardware - i.e. pressing either SHIFT changes midi codes of some controls on *both* decks.
- SHIFT + TAP does not trigger BPM rescan, as there is no Mixxx control for this action.

### 17.1.84 Numark Mixtrack Pro II

The Numark Mixtrack Pro II is the successor of *Numark Mixtrack Pro* and features the same hardware with some minor design changes.

- [Manufacturer's product page](#)
- [Forum thread](#)

Nuovo nella versione 1.11.

## Mapping Description

### 1. Browser Knob

Rotate the knob to cycle through folders and tracks.

**Press:** Same as Back button.

### 2. Load

Load the track selected in the library to the deck.

### 3. Back

Cycles between the file structure and the music library in the software.

### 4. Shift

Allows multiple control commands to be triggered when pressed and held first along with other buttons.

### 5. Play/Pause

Starts and suspends playback.

**Shift + Play/Pause:** Activates *soft start* effect if paused or *brake* effect if playing.

## 6. Headphone Cue

Sends pre-fader audio to the Cue Channel for headphone monitoring.

## 7. Cue (Transport Control)

The behavior depends on the *cue mode* set in the Mixxx preferences. **Shift + Cue**: return the play head to the start of the track.

## 8. Platter/Jog Wheel

This capacitive, touch-sensitive jog wheel controls the audio when the wheel is touched and moved. When the Scratch button is not active, use the wheel to bend the pitch of the track. When the Scratch button is active, use the wheel to grab and move the audio, “scratching” the track as you would with a vinyl record. You can also grab the non-touch-sensitive outer wheel to bend the pitch of the track.

## 9. Scratch

Controls the behavior of the platters. When not active, the platter will function as Pitch Bend. When active, the platter will have the ability to scratch.

## 10. Pitch Fader

Controls the tempo (speed) of the individual decks.

## 11. Pitch Bend -

Press and hold to momentarily reduce the speed of the track.  
**Shift + Pitch Bend -**: Toggles keylock on/off.

## 12. Pitch Bend +

Press and hold to momentarily increase the speed of the track.  
**Shift + Pitch Bend +**: Changes pitch fader range.

## 13. Sync

Enables BPM syncing between decks.

## 14. Effect Control

Adjusts effect metaknobs.

**Shift + Effect Control:** Selects effect.

## 15. Beats

Adjusts the Dry/Wet mix of the EffectUnit.

**Shift + Beats:** Adjust the deck's QuickEffect.

## 16. Loop In

Function of this button depends on the current Pad Mode.

**Shift + Loop In:** Sets the current Pad Mode to "Loop Mode".

**Loop Mode:** Press this pad to set the beginning of a loop.

**Sample Mode:** Plays the sample assigned to Sampler 1 (left deck) or Sampler 5 (right deck).

**Cue Mode:** If Hotcue 1 has not already been set for the loaded track, this control will set Hotcue 1 at current position in the track. If Hotcue 1 has already been set, this control will jump to Hotcue 1.

## 17. Loop Out

Function of this button depends on the current Pad Mode.

**Shift + Loop Out:** Sets the current pad mode to "Sample Mode".

**Loop Mode:** Set the end of a loop.

**Sample Mode:** Plays the sample assigned to Sampler 2 (left deck) or Sampler 6 (right deck).

**Cue Mode:** If Hotcue 2 has not already been set for the loaded track, this control will set Hotcue 2 at current position in the track. If Hotcue 2 has already been set, this control will jump to Hotcue 2.

## 18. Reloop

Function of this button depends on the current Pad Mode.

**Shift + Reloop:** Sets the current pad mode to "Cue Mode".

**Loop Mode:** Deactivate an active loop. If no loop is active, this will activate the loop and start playback from its Loop In point.

**Sample Mode:** Plays the sample assigned to Sampler 3 (left deck) or Sampler 7 (right deck).

**Cue Mode:** If Hotcue 3 has not already been set for the loaded track, this control will set Hotcue 3 at current position in the track. If Hotcue 3 has already been set, this control will jump to Hotcue 3.

## 19. Loop x1/2

Function of this button depends on the current Pad Mode.

**Loop Mode:** Half the loop size.

**Shift + Loop x1/2 when in Loop Mode:** Double the loop size.

**Sample Mode:** Plays the sample assigned to Sampler 4 (left deck) or Sampler 8 (right deck).

**Cue Mode:** Toggles Hotcue Delete Mode. Press this button, and then press one of the other pads in the row to delete that Hotcue.

**Note:** This button is lit when in Hotcue Delete Mode.

## 20. FX 1 On/Off

Toggle the 1st effect in the unit on/off.

**Shift + FX 1:** Sets and starts playback of a 1-beat autoloop.

## 21. FX 2 On/Off

Toggle the 2nd effect in the unit on/off.

**Shift + FX 2:** Sets and starts playback of a 2-beat autoloop.

## 22. FX 3 On/Off

Toggle the 3rd effect in the unit on/off.

**Shift + FX 3:** Sets and starts playback of a 4-beat autoloop.

## 23. Tap

Allows manual entry of song's BPM by repeated pressing along the beats of the track.

**Shift + Tap:** Sets and starts playback of a 16-beat autoloop.

**Note:** This button will blink at each detected beat in the track.

## 24. Channel Volume

Adjusts the volume of the deck.

## 25. Master Gain

Adjusts the volume of the master mix coming from the software.

**Note:** This does not affect the microphone volume. Use the Mic Gain knob to control the microphone volume.

## 26. Crossfader

Controls the blend between the two decks.

## 27. High EQ

Controls the treble frequencies for the deck.

## 28. Mid EQ

Controls the mid range frequencies for the deck.

## 29. Low EQ

Controls the bass frequencies for the deck.

## 30. Cue Gain

Adjusts the volume for headphone cueing in the software.

## 31. Cue Mix

Adjusts the software's audio output to the headphones, mixing between the cue output and the master mix output.

## 32. Stutter

Press this button while the music is playing to jump back to the last set cue point, creating a "stutter" effect.

### 17.1.85 Numark N4

The Numark N4 is a 4-deck DJ controller with seamless integration of external devices.

- [Manufacturer’s product page](#)
- [Wiki page](#)

Nuovo nella versione 1.10.

#### Mapping Description

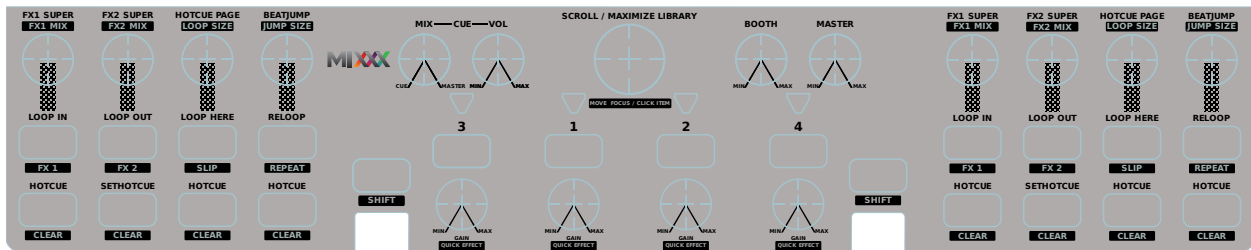

Figure35: Numark N4 (schematic view)

This mapping has some unusual features like per Deck shift buttons and multiple pages of hotcues. An annotated, ready-to-print overlay of this mapping can be downloaded for DIN A3 and DIN A4 printers.

#### Definable Settings

Some settings in the script can be changed by editing them at the top of the script.

**searchAmplification** Defines the speedup-factor used when using the searchbutton and scrolling.

*type:* number

*range:* ]0;+∞[

**warnAfterTime** Time in seconds before the end of the track in which the controller should warn you.

*type:* number

*range:* [0;+∞]

**blinkInterval** Timeinterval for the triangular Leds in ms

*type:* number

*range:* [20;+∞[

**encoderResolution** Percent how much the value changes with each encoder tick

*type:* number

*range:* ]0;1]

**resetHotCuePageOnTrackLoad** The Hotcuepage should be reset to 1 when a new Track is loaded into the Deck

*type:* boolean  
*range:* true or false

**cueReverseRoll** If [SHIFT]+[CUE] should trigger a reverse\_roll

*type:* boolean  
*range:* true or false

**rateRanges** An array of rateRanges in percent

*type:* array  
*range:* ]0;3]

## Deck

The Deck consists of the jogwheel, play, cue, the topContainer (which hold the eight square buttons and the four encoders), pitchslider, pitchrange, search, keylock, tap, sync and pitchbend ±.

## Special Features

The mapping features some peculiar features which might not be discoverable by standard trial-and-error.

## Shift

A shift button is bound to its Deck, which means that you can't use the shift button of Deck1 to access a shifted function on any of the other three Decks. Moreover the shiftbuttons can also work as toggle switches instead of pushbuttons (enabled via components.js Button.type.powerWindow). This means that if the shiftbutton is pressed for a longer period than 275ms it will bounce back to its original state (like a regular shift-/pushbutton). If the Button was pressed for a shorter period than 275ms, the button will remain in that state until it is pressed again (like a toggling button).

## Hotcues

The four lower buttons of the topContainer are hotcues. They can be changed by using the corresponding Encoder [HOTCUE PAGE]. The current assignment will then be shown for one second in the upper row. Currently up to 4 Pages are supported (with 4 hotcues each). A demo of how this looks can be seen on [JsFiddle](#) (not done yet) (the slider represents the Encoder).

## Controls

Most of these controls behave as expected but they are listed in detail for the sake of completeness anyways.



## Play

Default: Starts regular Play.

Shifted: Plays Track in reverse.

## Cue

Default: Standard Cue.

Shifted: reverse roll if shift is enabled (plays in reverse end enables slip) otherwise standard cue.

## Pitchbend ±

Default: Change rate temporarily.

Shifted: Change rate temporarily small.

## Sync

Default: Momentary BPM Sync

\* Short Press: Momentary BPM & Phase Sync

- Long Press: Toggle Master Sync (Sync Lock)

Shifted: Toggles magnet (quantize)

## Tap

Default: Tap the desired BPM of the Channel

Shifted: ^^

Note: This functionality is broken until #1811 gets merged

## Search/Scratch

Default: Enable Scratching (otherwise it just works just like moving the Jog without the platter)

Shifted: Speeds up platter movement for searching within the track

## Keylock

Default: Toggles track keylock

Shifted: Syncs Key

## Pitch Range

Default: Cycles Through pitchranges

Shifted: ^^

## Pitch/Bpm slider

Default: Normal Pitchslider (Down plays faster; can be changed in the global mixxx preferences)

Shifted: ^^

## TopContainer

The TopContainer holds four assignable Hotcue buttons, four loop buttons, which can enable FX via Shift, and four Encoderknobs.

## Hotcues

Default: set/active Hotcue\_X

Shift: clear Hotcue\_X

*visit#special\_featuresfor more info on how these work*

## Loop In

Default: Presses the Loop In button like in the UI

Shifted: Toggles EffectRack1

## Loop Out

Default: Presses the Loop Out button like in the UI

Shifted: Toggles EffectRack2

## Loop Here

Default: Creates a loop at the current position of current Loop Size.

Shifted: Toggles Slip

## Reloop

Default: De-/Re-activates the last loop

Shifted: Jumps to start of last loop and stops playback there

## FX1 Knob

Default: Controls the Super Knob on EffectRack1.

Shifted: Controls the Mix Knob on EffectRack1.

## FX2 Knob

Default: Controls the Super Knob on EffectRack2.

Shifted: Controls the Mix Knob on EffectRack2.

## Hotcue Page

Default: visit *#special\_features* for more info on what this encoder does

Shifted: Double/Halve current Loop Size

## Beat Jump

Default: Jump in the direction turned

Shifted: Double/Halve current Beat Jump Size

## Mixer

The Mixer features four channels with identical functionality and controls for the library and other miscellaneous features.

## Channel

A channel consists of a volume fader, a gain knob, knobs for low,mid,high EQ a Loadbutton and a pfButton. These are internally still part of the Deck which is why the shiftbutton of Deck 1 won't work with the Loadbutton or gainknob of Deck2/3/4.

## Volume

Default: Channel Volume

## CUE

Default: Channel Pre-Fader-Listening

*these work as usual on the N4: Clicking another one deselect all other. Press multiple at the same Time to PFL multiple Channels*

## BASS

Default: EQ Low

## MID

Default: EQ Mid

## TREBLE

Default: EQ High

## GAIN

Default: Gain

Shifted: QuickEffect1 (Usually Filter)

## LOAD

Default: Load Track into Deck

Shifted: Eject Track from Deck

## Library

The Library is managed via the Library Encoder. **Any** shiftbutton can be used to access shift functionaly

## Turn

Default: Move Library Cursor Vertically

Shifted: Move Focus between panes

*sometimes the focus is stuck somewhere (eg when using the searchbox) and is only recoverable with user intervention via a pointing device.*

**Button** Default: Open/Close Folder / Load Item into first available Deck (Context-dependent)

Shift: Maximize Library

## Miscellaneous

### Crossfader

The Crossfader and its assignment buttons are integrated seamlessly with Mixxx.

### Line/PC Input Source

Function as expected: Mutes the corresponding Deck in Mixxx if set to Line.

### Crossfader Contour

Normal: Uses the crossfader parameters that were present when the mapping was loaded Scratch: Uses Scratch typical parameters for hard cuts

### Cue-Master Mix

Doesn't manipulate the mixxx controls. Make sure the head gain is not zero and the mix is set to 100% PFL

### Cue Volume

Make sure its high enough within mixxx

### Booth/Gain Volume

Behaves as expected (but doesn't manipulate any mixxx controls).

### 17.1.86 Numark NS7

This all-in-one controller features motorized jogwheels. This device is not USB MIDI class compliant and requires a special driver which is only available for Windows and Mac OS X. There is no Linux driver. This controller has been discontinued in favor of the NS7III.

- [Manufacturer's product page](#)

Nuovo nella versione 1.9.

---

**Nota:** Unfortunately a detailed description of this controller mapping is still missing. If you own this controller, please consider [contributing one](#).

---

### 17.1.87 Numark Omni Control

- [Manufacturer's product page](#)

Nuovo nella versione 1.10.

---

**Nota:** Unfortunately a detailed description of this controller mapping is still missing. If you own this controller, please consider [contributing one](#).

---

### 17.1.88 Numark Total Control

- [Manufacturer's product page](#)
- [Forum thread](#)

Nuovo nella versione 1.6.

---

**Nota:** Unfortunately a detailed description of this controller mapping is still missing. If you own this controller, please consider [contributing one](#).

---

### 17.1.89 Numark V7

- [Manufacturer's product page](#)
- [Forum thread](#)

Nuovo nella versione 1.10.

---

**Nota:** Unfortunately a detailed description of this controller mapping is still missing. If you own this controller, please consider [contributing one](#).

---

### 17.1.90 Pioneer CDJ-2000

This is a CD and USB media player that can control Mixxx over USB with MIDI or HID. It can also control Mixxx by playing timecode from a CD or USB drive and running that signal into Mixxx through a sound card.

- [Manufacturer's product page](#)

Nuovo nella versione 1.10: Support for *MIDI* mode.

Nuovo nella versione 1.11: Support for *HID* mode.

---

**Nota:** Unfortunately a detailed description of this controller mapping is still missing. If you own this controller, please consider [contributing one](#).

---

### 17.1.91 Pioneer CDJ-350

This is a CD and USB media player that can control Mixxx via USB with MIDI. The device can also send HID signals to computers, but no Mixxx mapping has been made for this device's HID signals. It can also control Mixxx by playing timecode from a CD or USB drive and running that signal into Mixxx through a sound card.

- [Manufacturer's product page](#)
- [Forum thread](#)

Nuovo nella versione 1.8.2: Support for *MIDI* mode.

---

**Nota:** Unfortunately a detailed description of this controller mapping is still missing. If you own this controller, please consider [contributing one](#).

---

### 17.1.92 Pioneer CDJ-850

This is a CD and USB media player that can control Mixxx via USB with MIDI or HID. It can also control Mixxx by playing timecode from a CD or USB drive and running that signal into Mixxx through a sound card.

- [Manufacturer's product page](#)

Nuovo nella versione 1.10: Support for *MIDI* mode.

Nuovo nella versione 1.11: Support for *HID* mode.

---

**Nota:** Unfortunately a detailed description of this controller mapping is still missing. If you own this controller, please consider [contributing one](#).

---

### 17.1.93 Pioneer DDJ-200

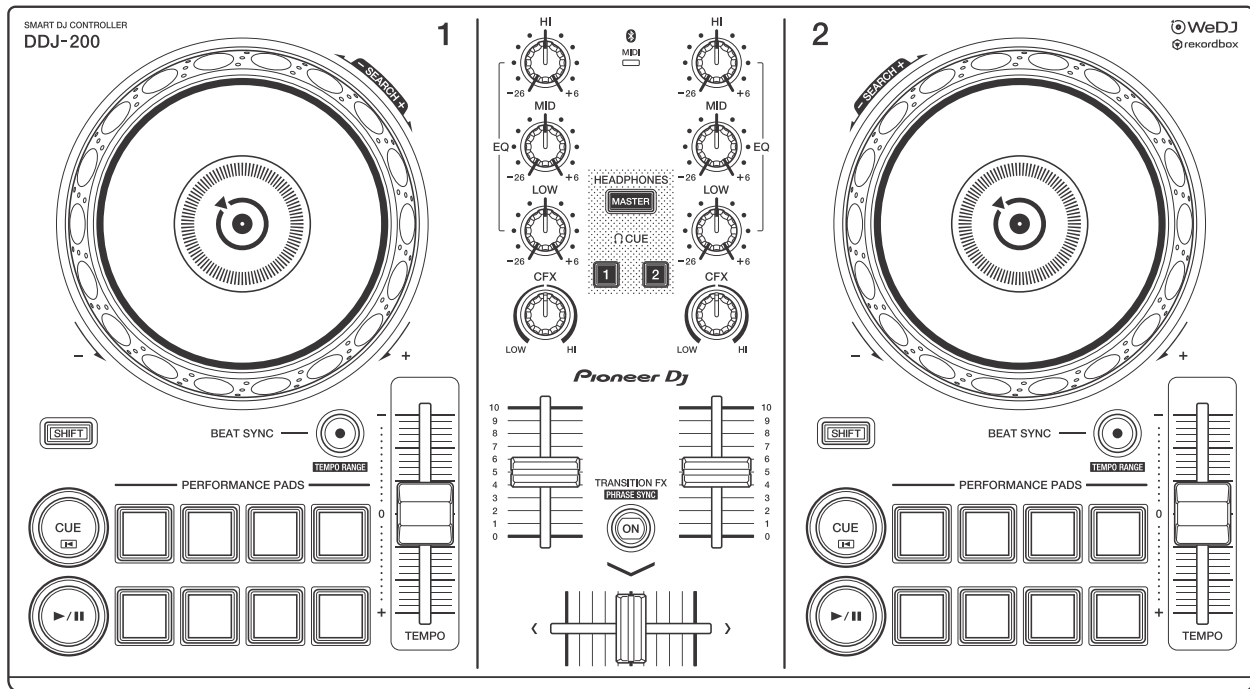

Figure36: Pioneer DDJ-200 (schematic view)

The Pioneer DDJ-200 is a 2 deck USB and Bluetooth DJ controller designed for WeDJ, djay, edjing Mix and Rekordbox.

- [Manufacturer's Product Page](#)
- [Manufacturer's User Manual](#)
- [Manufacturer's Firmware Update](#)
- [Mixxx User Forum](#)

Nuovo nella versione 2.2.5.

#### Controller Mapping

A schematic drawing with the control numbers that are used here can be found on the specified page in the User Manual in the Links section.



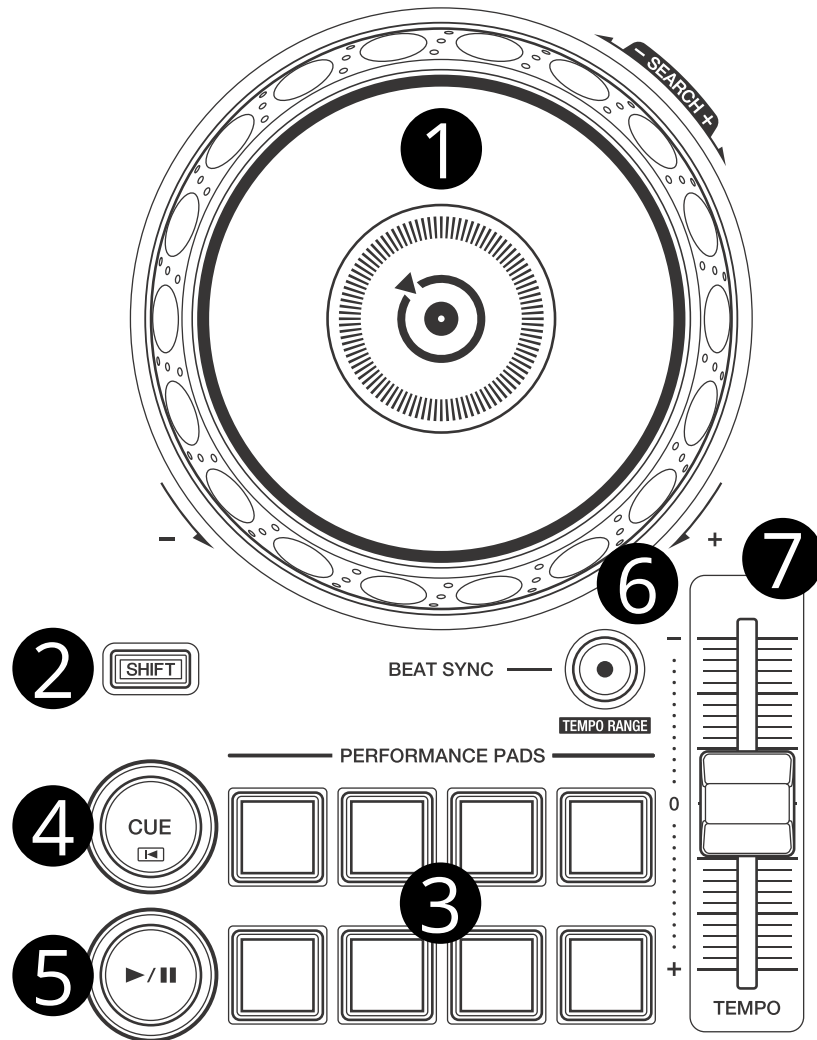

Figure37: Deck section (p. 8)

**Deck section (p. 8)**

| No. | Control                          | Function   |
|-----|----------------------------------|--|
| 1   | Jog Wheel (top)                  | Scratch (move play position)   |
| 1   | Jog Wheel (outer)                | Pitch bend (nudge)   |
| 1   | SHIFT + Jog Wheel (top)          | Scratch (move play position) faster                                      |
| 1   | SHIFT (left) + Jog Wheel (outer) | Move track selection in library  |
| 2   | SHIFT button                     | Switch function of controls  |
| 3   | Pad 1 - 8                        | Set (if empty) or play (if set) hot cue point / loop 1 - 8               |
| 3   | SHIFT + Pad 1 - 8                | Unset / delete hot cue 1 - 8   |
| 4   | CUE button                       | Set or play cue point, change cue point with JOG WHEEL (top) + cue point |
| 4   | SHIFT + CUE button               | Return to cue point and stop   |
| 5   | PLAY/PAUSE button                | Play / pause   |
| 6   | BEAT SYNC button                 | Match tempo and phase of other deck, long press to enable master sync    |
| 7   | TEMPO slider                     | Adjust track playing speed (can be adjusted via SHIFT + BEAT SYNC)       |

**Mixer section (p. 10)**

| No. | Control                         | Function   |
|-----|---------------------------------|--|
| 1   | MASTER button                   | Toggle Master/Cue knob of headphones between left and right  |
| 1   | SHIFT + MASTER button           | Toggle between 2- and 4-deck mode  |
| 2   | HI/MID/LOW knobs                | Adjust high/mid/low-frequencies  |
| 3   | CFX knobs                       | Turns on the selected effects  |
| 4   | HEADPHONE CUE 1 button          | Toggle headphone pre-fader listening of left deck.   |
| 4   | HEADPHONE CUE 2 button          | Toggle headphone pre-fader listening of right deck.  |
| 4   | SHIFT (left) + HEADPHONE CUE 1  | Load selected track to left deck.  |
| 4   | SHIFT (left) + HEADPHONE CUE 2  | Load selected track to right deck.   |
| 4   | SHIFT (right) + HEADPHONE CUE 1 | Toggle between left deck between 1 / 3 in 4-deck mode (if LED is lit, deck 3 is active). If 4-deck mode is disabled, this behaves the same as SHIFT (left) + HEADPHONE CUE 1.  |
| 4   | SHIFT (right) + HEADPHONE CUE 2 | Toggle between right deck between 2 / 4 in 4-deck mode (if LED is lit, deck 4 is active). If 4-deck mode is disabled, this behaves the same as SHIFT (left) + HEADPHONE CUE 2. |
| 5   | Channel faders                  | Adjust the output level for each channel   |
| 6   | Transition FX Button            | Turns on <i>AutoDJ</i>   |
| 7   | Cross fader                     | Fade between left and right deck   |

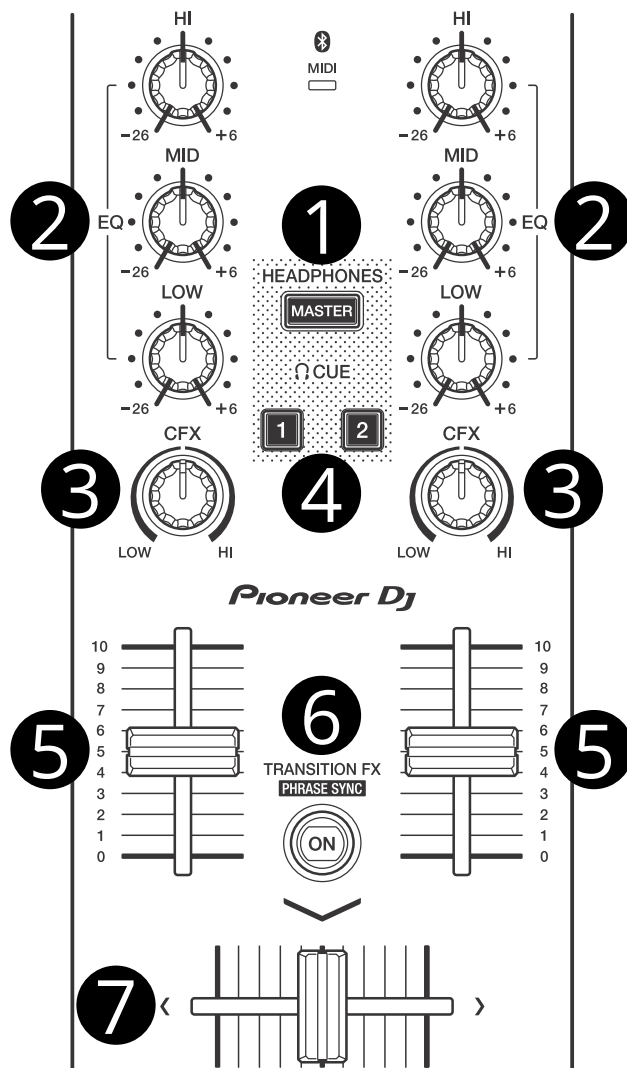

Figure38: Mixer section (p. 10)

## 17.1.94 Pioneer DDJ-400

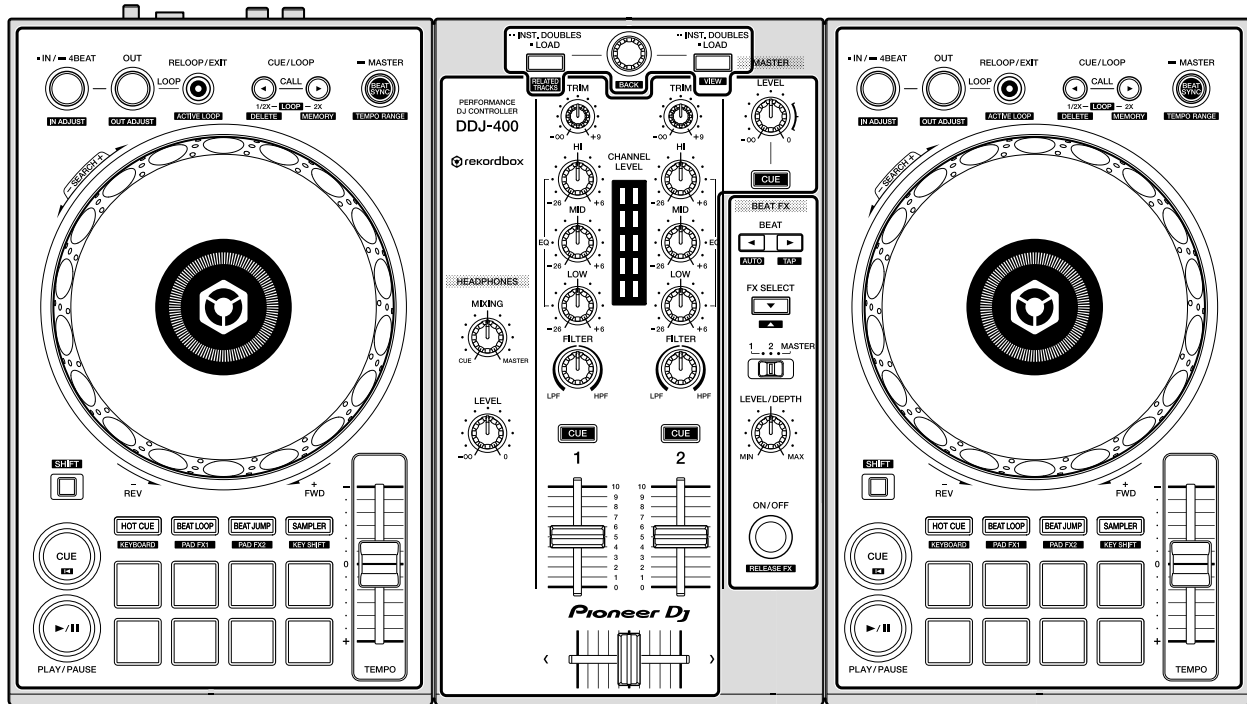

Figure39: Pioneer DDJ-400 (schematic view)

The Pioneer DDJ-400 is a 2 deck USB controller with an integrated audio interface designed for rekordbox.

- [Manufacturer's Product Page](#)
- [Manufacturer's User Manual](#)
- [Manufacturer's Firmware](#)
- [Midi Mappings](#)
- [Hardware Diagram](#)
- [Mapping Forum Thread](#)

Nuovo nella versione 2.3.0.

### Firmware

**Nota:** The release version of the firmware contains a bug which causes signals from the tempo sliders to be sent without the sliders being touched.

It is therefore highly recommended that you update your controller's firmware.

You can download the latest firmware from [the manufacturer's website](#).

Unfortunately Pioneer only offers a Windows and Mac firmware installer, so to update your controller you will need access to such a machine. Simply download the appropriate file for that OS, attach your device and run the installer.

## Compatibility

The Pioneer DDJ-400 is USB audio and MIDI class compliant and works with Linux, Windows, and macOS without needing to install any drivers. However, updating the firmware is recommended as described above.

## Audio Setup

Configure Mixxx's *sound hardware settings* as follows:

| Output     | Channel |
|------------|---------|
| Master     | 1-2     |
| Headphones | 3-4     |

**Nota:** It is not possible to record or broadcast input sent from the 1/4» unbalanced TS microphone jack on the controller, as it is not routed back to the computer and cannot be configured as an input device.

## Controller Mapping

The schematic drawings used here can be referenced in the [manufacturer's manual](#) on the given page number.

### Browser section (p. 6)

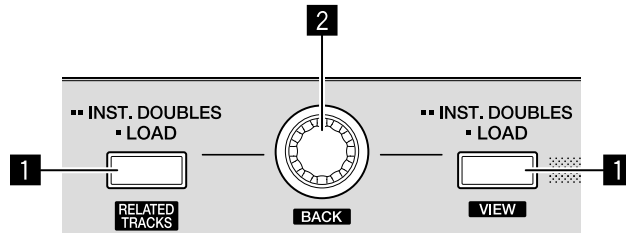

Figure40: Pioneer DDJ-400 (browser section)

| No. | Control         | Function  |
|-----|-----------------|---|
| 1   | LOAD buttons    | Load track selected in library into deck.   |
| 2   | Rotary Selector | Press to toggle focus between the library sidebar and associated panels. Turn to move focus up or down. |

Deck sections (p. 6)

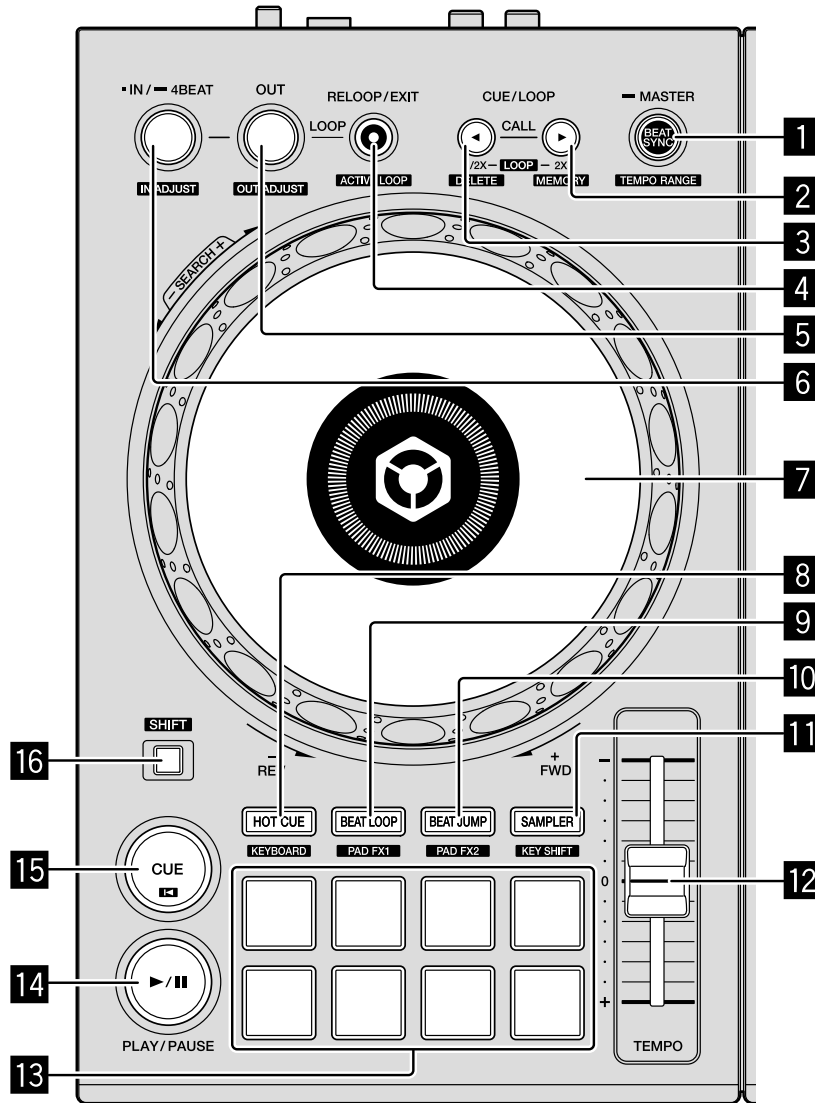

Figure41: Pioneer DDJ-400 (deck section)

| No. | Control                | Function   |
|-----|------------------------|--|
| 1   | BEAT SYNC              | Press to sync tempo to the other playing track. Hold to enable sync lock.  |
| 1   | SHIFT + BEAT SYNC      | Cycles through tempo ranges: +/-6%, +/-10%, +/-16%, +/-25%   |
| 2   | CUE/LOOP CALL>         | Doubles the current loop size.   |
| 2   | SHIFT + CUE/LOOP CALL> | Jumps 32 beats forwards.   |
| 3   | CUE/LOOP CALL<         | Halves the current loop size.  |
| 3   | SHIFT + CUE/LOOP CALL< | Jumps 32 beats backwards.  |
| 4   | RELOOP/EXIT            | Enables/disables currently set loop.   |
| 4   | shift + RELOOP/EXIT    | Jump to loop start, enable loop, and stop playback.  |
| 5   | OUT                    | Sets end of loop to the current playback position. If quantize is enabled, it is set to the closest beat. If held during an active loop, sets the new end point when released.     |
| 5   | shift + OUT            | When a loop is enabled, press to adjust the loop's end position with the jog wheel.  |
| 6   | IN/-4BEAT              | Sets start of loop to the current playback position. If quantize is enabled, it is set to the closest beat. If held during an active loop, sets the new start point when released. |
| 6   | shift + IN/-4BEAT      | When a loop is enabled, press to adjust the loop's start position with the jog wheel.  |
| 7   | Jog Wheel (top)        | Scratch (move play position).  |
| 7   | Jog Wheel (outer)      | Nudge tempo up or down temporarily.  |
| 8   | HOT CUE mode           | Sets pads to <i>hot cue mode</i> .   |
| 9   | BEAT LOOP mode         | Sets pads to <i>beat loop mode</i> .   |
| 10  | BEAT JUMP mode         | Sets pads to <i>beat jump mode</i> .   |
| 11  | SAMPLER mode           | Sets pads to <i>sampler mode</i> .   |
| 12  | TEMPO slider           | Adjust playback speed.   |
| 13  | Performance pads       | Functionality differs depending on the pad mode selected by 8-11.  |
| 14  | PLAY/PAUSE             | Play/pauses a track).  |
| 15  | CUE                    | Behavior depends on the <i>cue mode</i> .  |

## Pad Modes

The pad mode buttons change between different modes in which the performance pads operate. The main pad modes described below are similar to those found in rekordbox.

**Nota:** The secondary pad modes described in the manufacturer's manual (KEYBOARD PAD FX1 PAD FX2 and KEYSHIFT) are not currently implemented by this mapping.

## Hot Cue Mode

Bookmark positions in the track and jump to them.

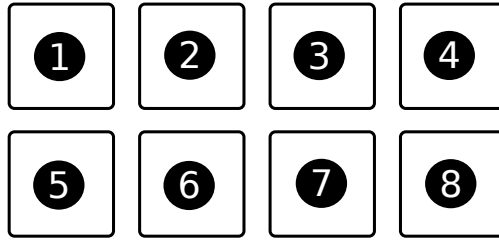

Figure42: Pioneer DDJ-400 (hot cue pads)

| No. | Control           | Function  |
|-----|-------------------|---|
| 1-8 | Pad (unlit)       | Save current position as hot cue.   |
| 1-8 | Pad (lit)         | Jump to hot cue. If the track is stopped, holding the pad will preview the hot cue until the pad is released. |
| 1-8 | SHIFT + Pad (lit) | Clear hot cue.  |

## Beat Loop Mode

Press a pad to enable a loop from the current position. Press the pad again to disable the loop. The size of the loop is assigned to the pads as follows:

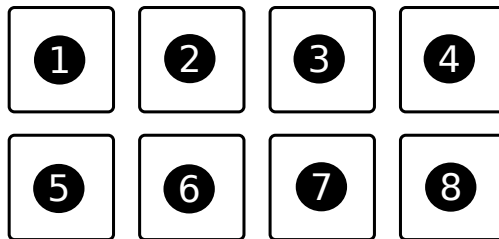

Table12: Pioneer DDJ-400 (beat loop sizes)

|          |          |          |          |
|----------|----------|----------|----------|
| 1/4 beat | 1/2 beat | 1 beat   | 2 beats  |
| 4 beats  | 8 beats  | 16 beats | 32 beats |

## Beat Jump Mode

Press a pad to jump forwards or backwards by the number of beats assigned to the pads below.

Press SHIFT + pad 7 to decrease or SHIFT + pad 8 to increase the jump values by a factor of 16.

Table13: Pioneer DDJ-400 (beat jump defaults)

|              |                 |              |                 |
|--------------|-----------------|--------------|-----------------|
| 1 beat back  | 1 beat forward  | 2 beats back | 2 beats forward |
| 4 beats back | 4 beats forward | 8 beats back | 8 beats forward |



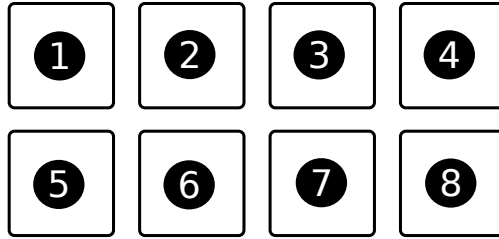

### Sampler Mode

Load and play samples from the library. The pads on decks 1 and 2 correspond to the first and second sampler rows in Mixxx respectively.

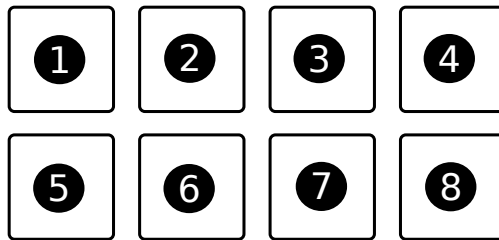

Figure43: Pioneer DDJ-400 (sampler pads)

| No. | Control           | Function  |
|-----|-------------------|---|
| 1-8 | Pad (unlit)       | Load sample selected in library.  |
| 1-8 | Pad (lit)         | Play a loaded sample. If the sample is already playing, playback starts from the beginning. |
| 1-8 | SHIFT + Pad (lit) | Stop a loaded sample from playing. If the sample is already stopped, unload it.             |

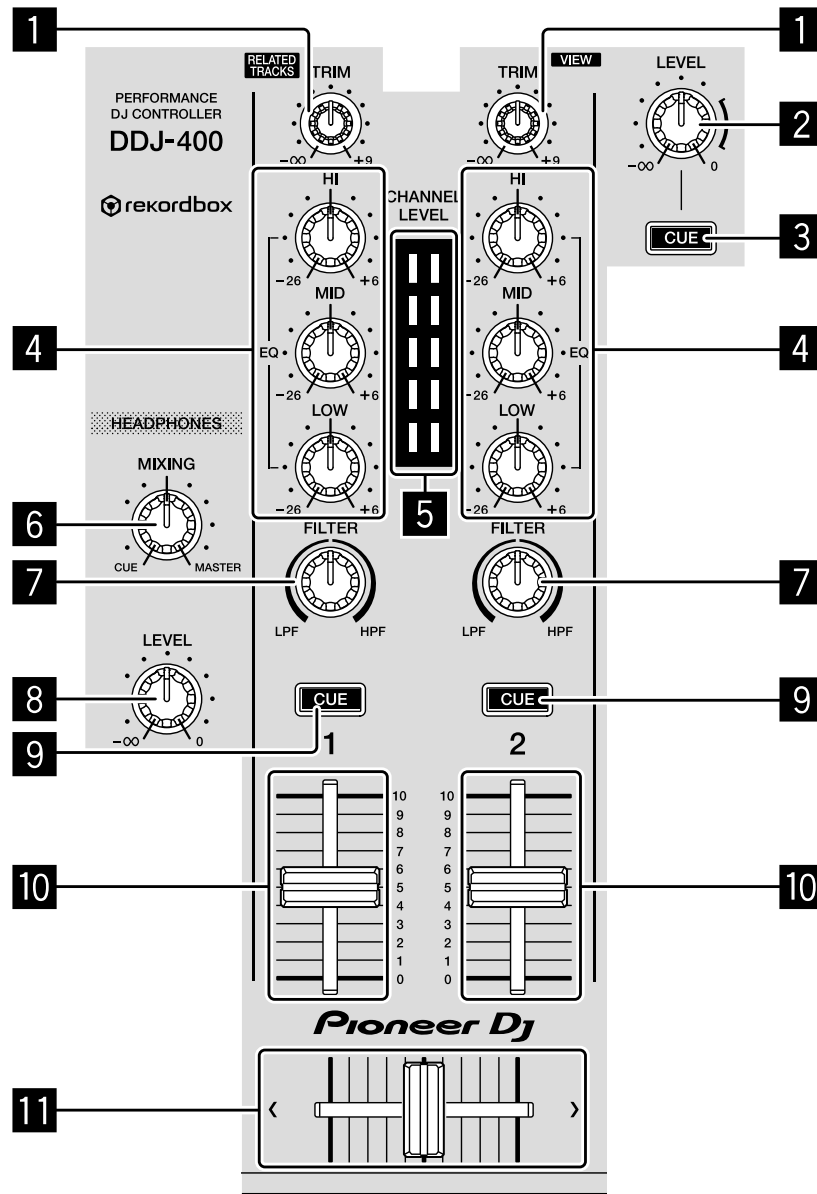

Figure44: Pioneer DDJ-400 (mixer section)

**Mixer section (p. 8)**

| No. | Control                  | Function  |
|-----|--------------------------|---|
| 1   | TRIM                     | Adjusts deck prefader gain  |
| 2   | MASTER                   | Adjusts master output (this is hardware implemented and is not mapped to the software gain in Mixxx).       |
| 3   | MASTER CUE               | Sends master output to headphones (this is hardware implemented and is not visible in the Mixxx interface). |
| 4   | EQs (LOW MID HIGH)       | Boosts or cuts channel frequencies  |
| 5   | Channel level indicators | Displays channel levels (before being sent through channel faders)  |
| 6   | HEADPHONES MIXING        | Adjusts between headphone CUE and MASTER levels sent to headphones  |
| 7   | FILTER                   | QuickEffect superknob (by default controls a Filter, but this can be changed in the <i>preferences</i> )    |
| 8   | HEADPHONES LEVEL         | Adjusts output level from PHONES jack   |
| 9   | Headphone CUE (Channel)  | Turn on to output channel to headphones   |
| 9   | SHIFT + Headphone CUE    | Toggles quantize for the current channel  |
| 10  | Channel fader            | Adjusts channel levels output to master   |
| 11  | Crossfader               | Fade between left and right channels  |

**Effect section (p. 9)**

The BEAT FX controls above are mapped to Mixxx's first effect unit as follows:

| No. | Control               | Function  |
|-----|-----------------------|---|
| 1   | BEAT <                | Focus effect 1  |
| 1   | SHIFT + BEAT <        | Load previous effect  |
| 2   | BEAT >                | Focus effect 2  |
| 2   | SHIFT + BEAT >        | Load next effect  |
| 3   | FX SELECT             | Focus effect 3  |
| 4   | Channel select switch | Route deck 1, deck 2 or master mix to effect unit 1         |
| 5   | LEVEL/DEPTH           | Controls the wet/dry mix knob                               |
| 5   | SHIFT + LEVEL/DEPTH   | Controls the metaknob of the currently focused effect       |
| 6   | ON/OFF                | Enable/disable the currently focused effect                 |
| 6   | SHIFT + ON/OFF        | Disables all effects in the chain and kills the wet/dry mix |

**Nota:** Soft takeover is enabled on the LEVEL/DEPTH knob to prevent sudden changes to the wet/dry mix or effect metaknob when changing between the two.

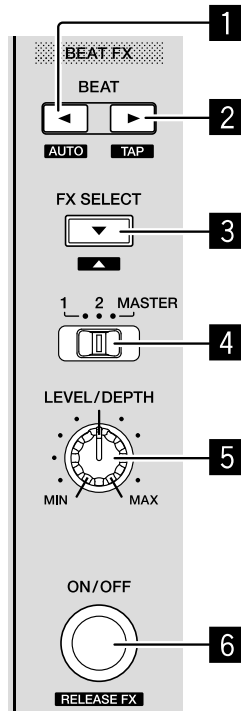

Figure45: Pioneer DDJ-400 (effect section)

### 17.1.95 Pioneer DDJ-SB

The Pioneer DDJ-SB is an all-in-one 2 deck USB *MIDI* controller with a built in soundcard. Mixxx allows it to control 4 decks.

- [Manufacturer's product page](#)
- [Forum thread](#)
- [GitHub pull request](#)

Nuovo nella versione 2.0.

#### Drivers

#### Windows

Windows Vista, Windows 7 and Windows 8 are supported. You can download the latest drivers and firmware from <http://www.pioneerdj.com/en/support/software/ddj-sb>.

**Nota:** If you're using Windows and have problems getting both sound outputs to work properly, please try using a different Sound *API* in the *preferences*. DirectSound seems to have issues with this controller. WASAPI seems to work fine, as does MME, although only with higher latencies. On Windows 10, only MME works.

## Mac OS X & Linux

You don't need any drivers on Mac OS X and Linux.

The controller supports Mac OS X 10.6 and up.

## Usage

### Library browsing

The controls for library browsing can be found in the center top of the controller.

| Control                     | Function  |
|-----------------------------|---|
| Rotary knob                 | Track selection   |
| Load buttons                | Loads currently highlighted track to the corresponding deck   |
| Pushing rotary knob         | Push: Loads currently highlighted track to the preview deck and plays it. – Release: jump to 30% position – Push again without rotary: Stop preview |
| Shift + rotary knob         | Library section selection   |
| Shift + pushing rotary knob | toggle expanding library section  |

### Switching between decks

Pressing Shift + “Key Lock / Tempo Range” allows the left deck to switch between decks 1 and 3 and the right deck to switch between decks 2 and 4.

### Volume, equalizers & filters

Between the decks the usual faders, crossfader and EQ knobs can be found. A filter knob is also available.

Knobs are available for the master and headphones level. These are functional but are not reflected in Mixxx, as they control the controller's soundcard directly.

The filter fade button allows to use the crossfader in an innovative way that fades across songs through filtering instead of fading.

There is no trim/gain knob, but the same effect can be achieved by using the filter knobs while holding shift.

### Jogwheels, tempo & vinyl mode

When a deck is paused, the jogwheel allows you to browse through a track. If you want to browse faster, hold shift while using the jogwheel.

When a deck is playing, using the jogwheel allows you to temporarily change the tempo of the playing track. Again, holding shift exaggerates this effect.

The tempo slider allows changing the tempo of each deck. This normally changes the pitch of a track, you can make the pitch stay constant by pressing the “key lock / tempo range” button.

Vinyl mode makes the jogwheels emulate the way turntables work. Vinyl mode can be toggled by pressing the “vinyl / slip” button. Touching the outer plastic ring of the jogwheel will make it behave as with vinyl mode off. Touching the

metal disc simulates touching the vinyl record, so just putting your hand on it will stop the “vinyl”. You can scratch in a similar way as with turntables in vinyl mode.

### Slip mode

By pressing shift + “vinyl / slip” you can toggle slip mode. When entering slip mode, Mixxx remembers what point exactly of the track should be playing even if, for example, you scratch or make a loop. This allows to return to the original pace of the track.

### Pads - lower row

The play and cue pads should be self-explaining. The sync pad toggles master sync for a deck, which tries to beatmatch the deck with the others, and also syncs the tempo between them, even when the tempo of one deck is changed.

Additional functions can be accessed by holding shift

| Control      | Function  |
|--------------|---|
| Shift + play | Plays the track in reverse and enables slipping (see slip mode)                                       |
| Shift + cue  | Brakes the track as if the power of the motor on a turntable was turned off                           |
| Shift + sync | Enables quantize mode (this makes most actions, e.g. setting the cue point, fall to the nearest beat) |

### Pads - hot cue mode

In hot cue mode the upper row of pads control the hotcues. Pressing a pad that is not lit sets a hotcue. Pressing a pad that is lit makes the track jump and play from that hotcue. Pressing a pad while holding shift deletes that hotcue.

You can control a set of 4 more hotcues by pressing shift + hot cue. The hot cue button will start blinking. The pads will behave in the same way, but controlling hotcues 5 to 8.

### Pads - auto loop mode

Pressing the pads in auto loop mode will make loops of a specific length measured in beats.

| Control       | Function     |
|---------------|--------------|
| Pad 1         | 1 beat loop  |
| Pad 2         | 2 beat loop  |
| Pad 3         | 4 beat loop  |
| Pad 4         | 8 beat loop  |
| Shift + pad 1 | 16 beat loop |
| Shift + pad 2 | 32 beat loop |
| Shift + pad 3 | 64 beat loop |

### Pads - manual loop mode

This mode will make the pads control looping in the way labeled on them.

| Control       | Function                    |
|---------------|-----------------------------|
| Pad 1         | Set loop in                 |
| Pad 2         | Set loop out                |
| Pad 3         | Toggles loop                |
| Pad 4         | Halve loop length           |
| Shift + pad 4 | Double loop length          |
| Shift + pad 1 | Move loop one beat backward |
| Shift + pad 2 | Move loop one beat forward  |

### Pads - sampler mode

In sampler mode the sampler can be controlled. To load a file into a sampler, first press the sampler button while holding shift, so that the sampler button starts blinking. Now pressing a pad will load the currently highlighted track on the library into the corresponding sampler. Pressing a pad while holding shift will eject the sample.

To play samples, press the sampler button without holding shift (it should not blink). Pressing a pad will start playing the corresponding sample, pressing a pad while holding shift will stop it.

### Pads - loop roll (shift + auto loop)

By pressing the auto loop button while holding shift (it should start blinking) you can make loop rolls. This mode combines auto loops with slip mode. The pads will start a loop in the current position with a determinate beat length while simultaneously enabling slip mode, so that when releasing the pad the track will continue playing as if the loop never happened.

| Control       | Function              |
|---------------|-----------------------|
| Pad 1         | 1/16th beat loop roll |
| Pad 2         | 1/8th beat loop roll  |
| Pad 3         | 1/4th beat loop roll  |
| Pad 4         | 1/2 beat loop roll    |
| Shift + pad 1 | 1 beat loop roll      |
| Shift + pad 2 | 2 beat loop roll      |
| Shift + pad 3 | 4 beat loop roll      |
| Shift + pad 4 | 8 beat loop roll      |

### Pads - kill (shift + manual loop)

By pressing the manual loop button while holding shift (it should start blinking) you can make the pads behave as kill switches.

| Control | Function  |
|---------|-----------|
| Pad 1   | Kill low  |
| Pad 2   | Kill mid  |
| Pad 3   | Kill high |
| Pad 4   | Mute      |

## Effects

Over the jogwheels there are sections allowing to control effects.

Turning the knobs will control the wet/dryness of an effect.

Turning the knobs while holding one of the three FX buttons will control the first, second or third parameter of an effect, respectively.

If holding shift when using the knobs the “super” parameter can be controlled.

Pressing the central FX button (number 2) while holding shift will toggle the effect for the headphones, while the left and right buttons (number 1 and 3) will toggle the effect for the active deck in the left and right sides of the controller respectively.

You can choose between effects by entering “kill mode” and using pads 1 and 2 while holding shift.

## Channel fader start

By moving a channel fader up from the very bottom while holding shift when a deck is paused, the deck will start playing. Moving the fader back to the bottom without releasing shift stops the deck and moves it back to its original position.

### 17.1.96 Pioneer DDJ-SB2

The Pioneer DDJ-SB2 is an all-in-one USB *MIDI* controller with a built in sound card. It has controls for 2 decks that can be toggled between decks to play with 4 decks.

- [Manufacturer’s product page](#)
- [Forum thread](#)

Nuovo nella versione 2.0.

## Audio

The sound card has 2 RCA jacks for the main output. There are two headphone jacks, one small (1/8“) and one large (1/4“) connector (each jack plays the same channels, they cannot be used for independent signals). There is a 1/4» microphone input with an adjustable gain knob. The microphone input is mixed directly with the main RCA outputs in hardware. It is not available to the computer, so cannot record or broadcast with the microphone input on the controller. You could use the controller with a separate USB *audio interface* that has a microphone input for that purpose. The microphone preamplifier is very noisy, so it is recommended to keep the microphone gain knob all the way down when not using a microphone, otherwise there will be noise added to the main RCA outputs.

## Windows

Pioneer has a [driver](#) for Windows versions 7 and newer. Select the ASIO sound *API* in Mixxx’s Sound Hardware Preferences.



## Mac OS X & Linux

The DDJ-SB2 is a USB class compliant *MIDI* and audio device, so it works with Mac OS X and Linux without any special drivers.

## User Options

There are some user configurable options for this mapping. To change the options, open the `.js` file in your controller for your Pioneer DDJ-SB2 with a text editor such as KWrite or GEdit on GNU/Linux, Notepad on Windows, or TextEdit on Mac OS X.

- **blinkingSync**: If true the sync button blinks with the beat, if false led is lit when sync is enabled.
- **invertVinylSlipButton**: If true, the vinyl button activates slip. Vinyl mode is then activated by using shift. Allows toggling slip faster, but is counterintuitive.
- **jogwheelSensitivity**: Sets the jogwheels sensitivity. 1 is default, 2 is twice as sensitive, 0.5 is half as sensitive.
- **jogwheelShiftMultiplier**: Sets how much more sensitive the jogwheels get when holding shift. Set to 1 to disable jogwheel sensitivity increase when holding shift.
- **speedRateToNormalTime**: Time per step (in ms) for pitch speed fade to normal
- **showVumeterMaster**: If true Level-Meter shows VU-Master left & right. If false shows level of channel: 1/3 2/4 (depending active deck)
- **cutVumeter**: Cut's Level-Meter low and expand upper. Fore example, at 0.5 only signals greater 50% show on the meter, expanded to full range
- **twinkleVumeterAutodjOn**: If true VU-Level twinkle if AutoDJ is ON.
- **jumpPreviewEnabled**: If true, when releasing the browser knob, the preview deck jumps forward to "position".
- **jumpPreviewPosition**: The place in the track to jump to, on a scale from 0 (beginning of track) to 1 (end of track).

## Usage

### Library browsing

The controls for library browsing can be found in the center top of the controller.

| Control                                  | Function   |
|--|--|
| Rotary knob                              | Track selection  |
| Load buttons                             | Loads currently highlighted track to the corresponding deck        |
| Pushing rotary knob                      | Loads currently highlighted track to the preview deck and plays it |
| Pushing rotary knob again without rotate | Stop the preview deck  |
| Shift + rotary knob                      | Library section selection (scroll through left pane of library)    |
| Shift + pushing rotary knob              | Toggle expanding library section                                   |

Pushing the rotary knob to start playing a track in the preview deck then releasing it jumps forward in the preview deck. This behavior can be disabled in the mapping's user options and the place in the track it jumps to can also be configured.

Addition functions not belonging to library:

- Shift & load left -> toggle effects view in/out
- Shift & load right -> toggle sampler view in/out

## Switching between decks

Press the deck button. It lights when deck 3-4 is active.

## Volume, equalizers & filters

Between the decks the usual faders, crossfader and EQ knobs can be found. A filter knob is also available.

Knobs are available for the master and headphones level. These control the controller's built in sound card; they do not control the software gains in Mixxx, so moving them does not move the master and headphone gain knobs on screen.

The filter fade button changes the crossfader from fading the volumes between decks to using filters to fade between decks.

The TRIM knob controls the deck's gain.

## Jogwheels, tempo & vinyl mode

When a deck is paused, the jogwheel allows you to browse through a track. If you want to browse faster, hold shift while using the jogwheel.

When a deck is playing, using the jogwheel allows you to temporarily change the tempo of the playing track. Again, holding shift exaggerates this effect.

The tempo slider allows changing the tempo of each deck. This normally changes the pitch of a track, but you can make the pitch stay constant by pressing the "key lock / tempo range" button. Additionally, with shift, the "key lock / tempo range" will fade the tempo slowly to 0. The fading speed can be customized with the speedRateToNormalTime mapping option.

Vinyl mode makes the jogwheels emulate the way turntables work. Vinyl mode can be toggled by pressing the "vinyl / slip" button. Touching the outer plastic ring of the jogwheel will temporarily change the tempo like when vinyl mode is off. Touching the metal disc simulates touching the vinyl record, so just putting your hand on it will stop the "vinyl". You can scratch in a similar way as with turntables in vinyl mode.

## Slip mode

By pressing shift + "vinyl / slip" you can toggle slip mode. When entering slip mode, Mixxx remembers what point exactly of the track should be playing even if, for example, you scratch or make a loop. When you press shift + slip again, Mixxx will jump back to that point.

## Pads - lower row

The play and cue pads should be self-explaining. The sync pad toggles master sync for a deck, which tries to beatmatch the deck with the others, and also syncs the tempo between them, even when the tempo of one deck is changed.

Additional functions can be accessed by holding shift

| Control      | Function   |
|--------------|--|
| Shift + play | Plays the track in reverse and enables slipping (see slip mode)  |
| Shift + cue  | Brakes the track as if the power of the motor on a turntable was turned off  |
| Shift + sync | Enables quantize mode (this makes most actions, e.g. pressing play or setting the cue point, fall to the nearest beat) |

### Pads - hot cue mode

In hot cue mode the upper row of pads control the hotcues. Pressing a pad that is not lit sets a hotcue. Pressing a pad that is lit makes the track jump and play from that hotcue. Pressing a pad while holding shift deletes that hotcue.

You can control a set of 4 more hotcues by pressing shift + hot cue. The hot cue button will start blinking. The pads will behave in the same way, but controlling hotcues 5 to 8.

### Pads - auto loop mode

Pressing the pads in auto loop mode will make loops of a specific length measured in beats.

| Control       | Function  |
|---------------|---|
| Pad 1         | set a loop of the selected number of beats  |
| Pad 2         | halve the selected loop length  |
| Pad 3         | double the selected loop length   |
| Pad 4         | reloop (reactivate a pre-existing loop)   |
| Shift + pad 1 | set a rolling loop of the selected number of beats  |
| Shift + pad 2 | beatjump backwards by the beatjump size, or move the loop backwards by the beatjump size if the loop is enabled |
| Shift + pad 3 | beatjump forwards by the beatjump size, or move the loop forwards by the beatjump size if the loop is enabled   |
| Shift + pad 4 | enable loop, jump to loop in marker, and stop playback  |

### Pads - manual loop mode

This mode allows you to set loops different from the fixed lengths of beats in auto loop mode.

| Control       | Function                    |
|---------------|-----------------------------|
| Pad 1         | Set loop in                 |
| Pad 2         | Set loop out                |
| Pad 3         | Toggles loop                |
| Pad 4         | Halve loop length           |
| Shift + pad 4 | Double loop length          |
| Shift + pad 1 | Move loop one beat backward |
| Shift + pad 2 | Move loop one beat forward  |

### Pads - sampler mode

In sampler mode the sampler can be controlled. To load a file into a sampler, first press the sampler button while holding shift, so that the sampler button starts blinking. Now pressing a pad will load the currently highlighted track on the library into the corresponding sampler. Pressing a pad while holding shift will eject the sample.

To play samples, press the sampler button without holding shift (it should not blink). Pressing a pad will start playing the corresponding sample, pressing a pad while holding shift will stop it.

### Pads - loop roll (shift + auto loop)

By pressing the auto loop button while holding shift (it should start blinking) you can make loop rolls. This mode combines auto loops with slip mode. The pads will start a loop in the current position with a determinate beat length while simultaneously enabling slip mode, so that when releasing the pad the track will continue playing as if the loop never happened.

| Control       | Function              |
|---------------|-----------------------|
| Pad 1         | 1/16th beat loop roll |
| Pad 2         | 1/8th beat loop roll  |
| Pad 3         | 1/4th beat loop roll  |
| Pad 4         | 1/2 beat loop roll    |
| Shift + pad 1 | 1 beat loop roll      |
| Shift + pad 2 | 2 beat loop roll      |
| Shift + pad 3 | 4 beat loop roll      |
| Shift + pad 4 | 8 beat loop roll      |

### Pads - kill (shift + manual loop)

By pressing the manual loop button while holding shift (it should start blinking) you can make the pads behave as EQ kill switches.

| Control | Function  |
|---------|-----------|
| Pad 1   | Kill low  |
| Pad 2   | Kill mid  |
| Pad 3   | Kill high |
| Pad 4   | Mute      |

### Effects

The knob controls the dry/wet knob of the whole effect chain when no effect is focused. When an effect is focused, the knob controls the metaknob of the focused effect. Focus an effect by pressing one of the effect buttons. To switch the controller's knob back to manipulating the dry/wet knob, unfocus by pressing the button of the focused effect again.

Press and hold an effect button to toggle the enable switch for that effect. The enable switches for each effect are not shown on the controller's LEDs, so you need to look at the screen to check whether an effect is on. All effects are off when Mixxx starts.

Use shift and the mixer knobs to control the parameters of the focused effect. The trim knob controls parameter 1, the equalizer knobs control parameters 2-4, and the filter knob controls parameter 5.

The DDJ-SB2 does not have enough buttons to control assigning effect units to different decks. You may want to set up a *custom keyboard mapping* to have easy access to those switches. Otherwise, you can use your mouse to click the buttons on screen.

## Auto DJ

Start/stop Auto DJ: Shift + DECK 4. If enabled in the user options enabled, the level meter LEDs twinkle.

Skip Track: Shift + DECK 3

## Channel fader start

By moving a channel fader up from the very bottom while holding shift when a deck is paused, the deck will start playing. Moving the fader back to the bottom without releasing shift stops the deck and moves it back to its original position.

### 17.1.97 Pioneer DDJ-SB3

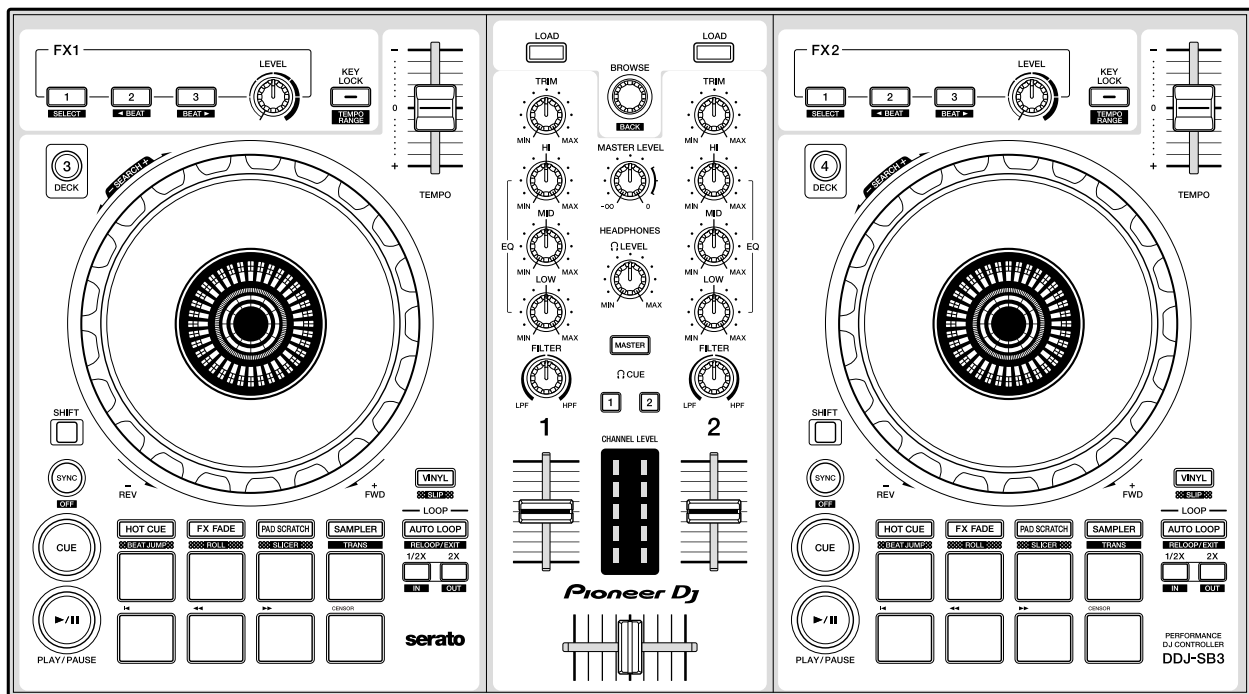

Figure46: Pioneer DDJ-SB3 (schematic view)

The Pioneer DDJ-SB3 is a 4 deck USB DJ controller.

- [Manufacturer's Product Page](#)
- [Manufacturer's User Manual](#)
- [Manufacturer's Firmware Update](#)
- [Mixxx User Forum](#)

Nuovo nella versione 2.3.2.

## Audio Setup

The mapping relies on the following channel assignments:

| Output Channels | Assigned to |
|-----------------|-------------|
| 1-2             | Master      |
| 3-4             | Headphones  |

This controller mapping does not support any inputs. The controller itself has a microphone input, but that cannot be controlled via MIDI or routed to the computer.

## Controller Mapping

A schematic drawing with the control numbers that are used here can be found on the specified page in the User Manual in the Links section.

### Deck section (p. 6)

| No. | Control                   | Function   |
|-----|---------------------------|--|
| 1   | TEMPO slider              | Adjust track playing speed (can be adjusted via SYNC)    |
| 2   | Jog Wheel (top)           | Pitch bend (nudge) or scratch when vinyl mode is enabled |
| 2   | Jog Wheel (outer)         | Pitch bend (nudge)                                       |
| 2   | SHIFT + Jog Wheel (top)   | Fast-forward or fast reverse track                       |
| 3   | HOT CUE                   | Set hot cue mode   |
| 3   | SHIFT + HOT CUE           | Set BEAT JUMP mode                                       |
| 4   | FX FADE                   | Set FX fade mode   |
| 4   | SHIFT + FX FADE           | Set roll mode  |
| 5   | PAD SCRATCH               | Set pad scratch mode                                     |
| 5   | SHIFT + PAD SCRATCH       | Set slicer mode  |
| 6   | SAMPLER                   | Set sampler mode   |
| 6   | SHIFT + SAMPLER           | Set trans mode   |
| 7   | VINYL                     | Toggle vinyl mode  |
| 7   | SHIFT + VINYL             | Toggle slip mode   |
| 8   | AUTO LOOP                 | Toggle auto loop   |
| 8   | SHIFT + AUTO LOOP         | Cancel loop or reloop                                    |
| 9   | 2X                        | Double loop length                                       |
| 10  | 1/2X                      | Halve loop length  |
| 11  | Pad 1 - 8                 | Perform different functions depending on current mode    |
| 12  | PLAY/PAUSE button         | Play / pause   |
| 12  | SHIFT + PLAY/PAUSE button | Return to temporary cue point                            |
| 13  | CUE button                | Set, play and call out cue points                        |
| 13  | SHIFT + CUE button        | Return to the beginning of the song                      |
| 14  | SYNC button               | Match tempo and phase to currently playing deck          |
| 15  | SHIFT + button            | Switch function of controls                              |
| 16  | DECK X                    | Switch deck  |
| 17  | KEY LOCK                  | Toggle key lock  |
| 17  | SHIFT + KEY LOCK          | Toggle tempo slider range                                |

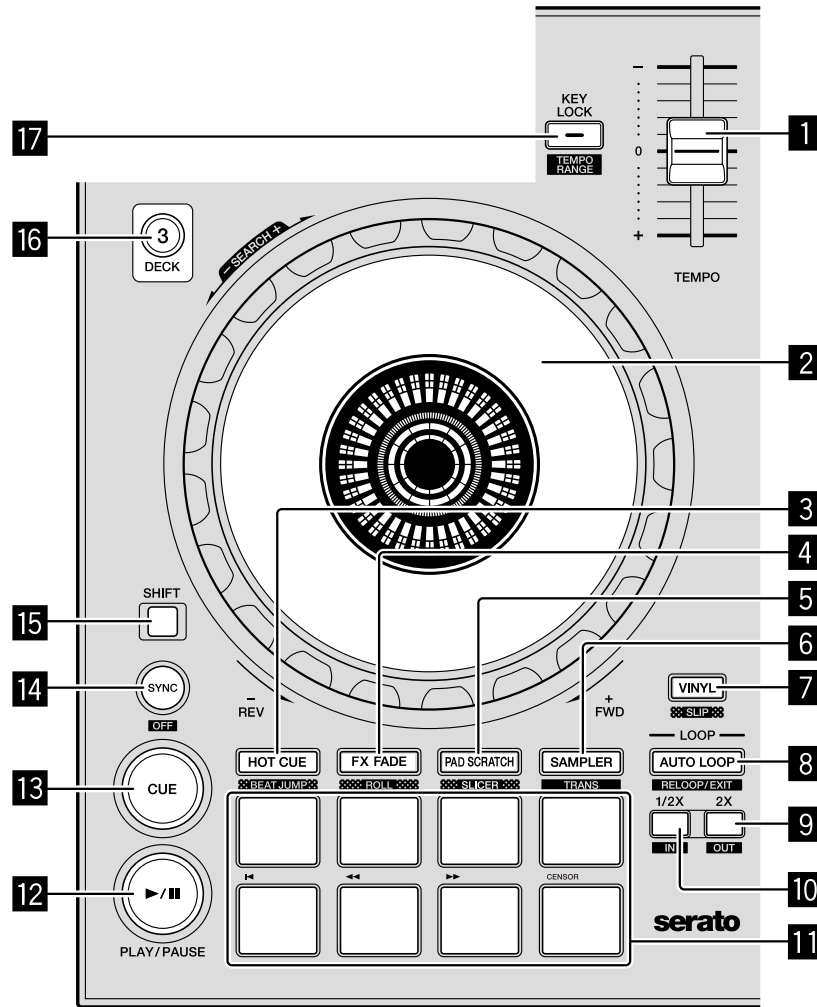

Figure47: Deck section (p. 6)

Mixer section (p. 8)

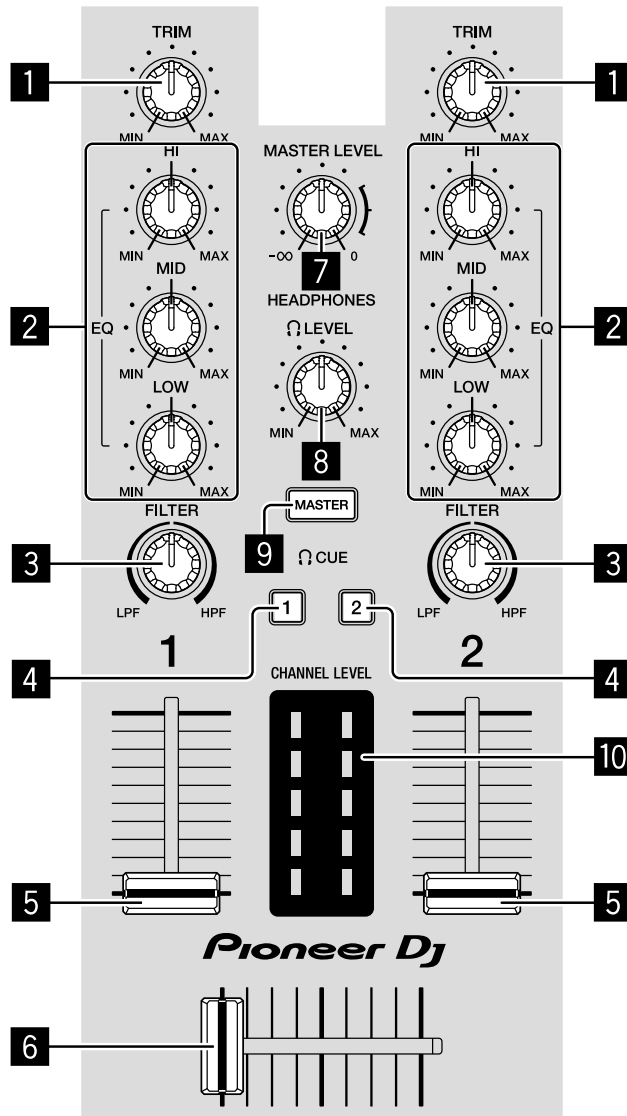

Figure48: Mixer section (p. 8)



| No. | Control                | Function   |
|-----|------------------------|--|
| 1   | TRIM knob              | Adjust individual channel output gain  |
| 2   | HI/MID/LOW knobs       | Adjust high/mid/low-frequencies  |
| 3   | FILTER knob            | Low pass / high pass filter for each channel   |
| 4   | HEADPHONE CUE 1 button | Toggle headphone pre-fader listening of left deck.   |
| 4   | HEADPHONE CUE 2 button | Toggle headphone pre-fader listening of right deck.  |
| 5   | Channel faders         | Adjust the output level for each channel   |
| 5   | SHIFT Channel faders   | Fader start and adjust the output level for each channel   |
| 6   | Cross fader            | Fade between left and right deck   |
| 7   | MASTER knob            | Adjust master output level. This changes the master output level directly on the controller's audio interface. The MAIN knob on the Mixxx UI will not change.          |
| 8   | HEAD-PHONES knob       | Adjust headphones output level. This changes the headphones' output level directly on the controller's audio interface. The HEAD knob on the Mixxx UI will not change. |
| 9   | MASTER button          | Output master to headphones  |

Effect section (p. 8)

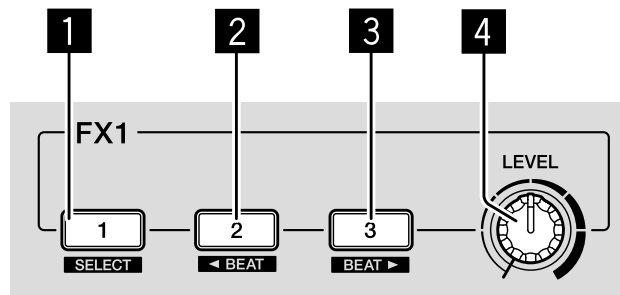

Figure49: Effects section (p. 8)

| No. | Control       | Function   |
|-----|---------------|--|
| 1   | 1 button      | Turns the effect on/off                                      |
| 1   | SHIFT1 button | Focuses the effect   |
| 2   | 2 button      | Turns the effect on/off                                      |
| 2   | SHIFT2 button | Focuses the effect   |
| 3   | 3 button      | Turns the effect on/off                                      |
| 3   | SHIFT2 button | Focuses the effect   |
| 4   | LEVEL knob    | Adjusts the mix of the dry and wet signal of the effect unit |

Browser section (p. 13)

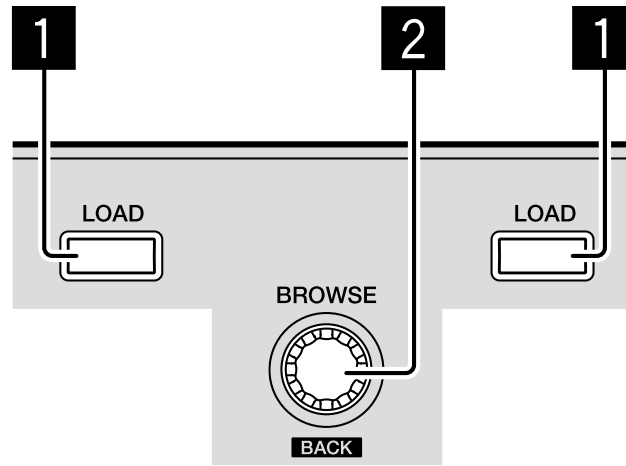

Figure50: Browser section (p. 13)

| No. | Control              | Function   |
|-----|----------------------|--|
| 1   | LOAD button          | Loads track highlighted in the library to the left or right deck                   |
| 2   | BROWSE knob (rotate) | Rotate the knob left or right highlights the previous or next track in the library |
| 2   | BROWSE knob (press)  | Starts / stops track preview of highlighted track                                  |

Performance Pads

You can use the Pad Mode Select buttons to select a mode for the performance pads. Performance pads are numbered from top left to bottom right. First row is 1-4 and the second row is 5-8. Press shift and the pad mode select button to access other pad modes.

Hot Cue Mode

Hot Cue mode is enabled by pressing the HOT CUE button. The button will light up when selected.

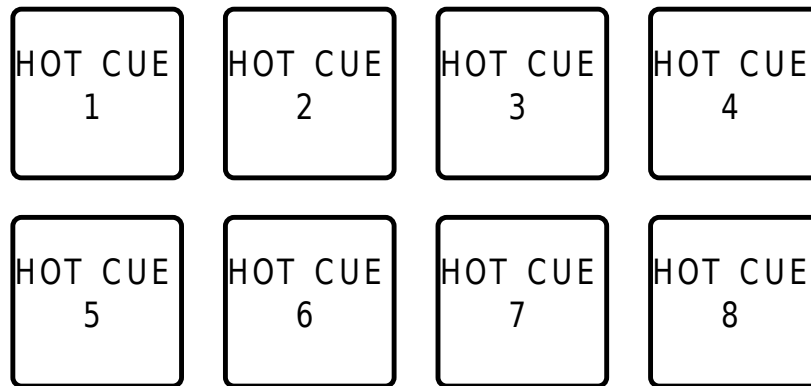

Figure51: Pioneer DDJ-SB3 (performance pads in hot cue mode)

Bookmark positions in the track and jump to them.

| No. | Control           | Function                          |
|-----|-------------------|-----------------------------------|
| 1-8 | Pad (unlit)       | Save current position as hot cue. |
| 1-8 | Pad (lit)         | Jump to hot cue.                  |
| 1-8 | SHIFT + Pad (lit) | Clear hot cue.                    |

### Beatjump Mode

Beatjump mode is enabled by holding SHIFT down and pressing the HOT CUE button. The button will flash when selected. Use beatjump mode to jump back or forward on the track by a certain number of beats.

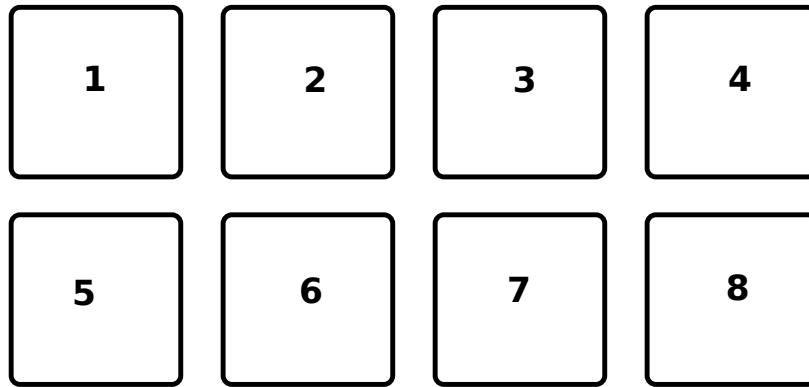

Figure52: Pioneer DDJ-SB3 (performance pads in beatjump mode)

| No. | Control | Function                      |
|-----|---------|-------------------------------|
| 1   | Pad     | Decrease beatjump size        |
| 2   | Pad     | Increase beatjump size        |
| 3   | Pad     | Jump left                     |
| 4   | Pad     | Jump right                    |
| 5   | Pad     | Go back to beginning of track |
| 6   | Pad     | Search left                   |
| 7   | Pad     | Search right                  |
| 8   | Pad     | Censor                        |

### FX Fade Mode

FX Fade mode is enabled by pressing the FX FADE button. The button will light up when selected. FX fade is a set of functions built-in to the controller.

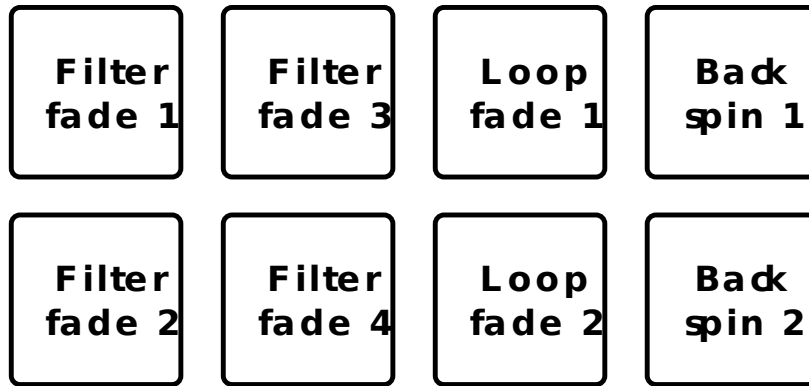

Figure53: Pioneer DDJ-SB3 (Fade mode performance pads)

| No. | Control        | Function                                   |
|-----|----------------|--|
| 1   | Pad (unlit)    | Applies a high-pass filter from off to max |
| 1   | Pad (blinking) | Turn off filter                            |
| 2   | Pad (unlit)    | Applies a low-pass filter from off to max  |
| 2   | Pad (blinking) | Turn off filter                            |
| 3   | Pad (unlit)    | Apply 1 beat auto-loop and lower volume    |
| 3   | Pad (blinking) | Turn off loop and restore volume           |
| 4   | Pad            | Perform a back-spin and resume             |
| 5   | Pad            | Same as pad 1 but over more time           |
| 6   | Pad            | Same as pad 2 but over more time           |
| 7   | Pad            | Auto-loop with exponential size reduction  |
| 8   | Pad            | Same as 4 but with a longer back-spin      |

### Loop Roll Mode

Loop roll mode is enabled by holding SHIFT down and by pressing the FX FADE button. The button will blink when selected. Press one of the pads to trigger a momentary loop roll. Once the pad is released, the track will resume playing.

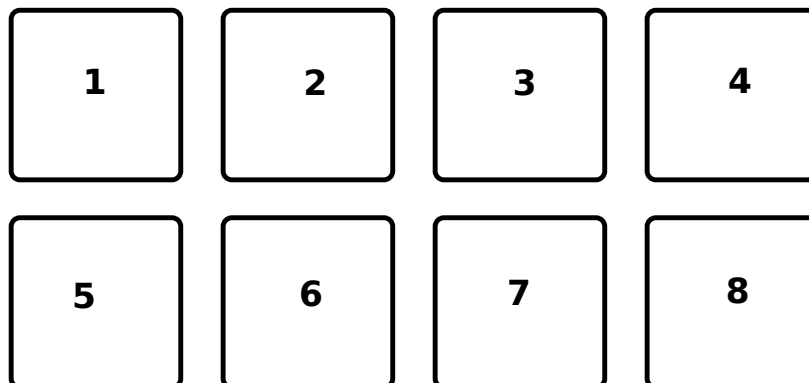

Figure54: Pioneer DDJ-SB3 (performance pads in loop roll mode)

| No. | Control | Function            |
|-----|---------|---------------------|
| 1   | Pad     | 1/16 beat loop roll |
| 2   | Pad     | 1/8 beat loop roll  |
| 3   | Pad     | 1/4 beat loop roll  |
| 4   | Pad     | 1/2 beat loop roll  |
| 5   | Pad     | 1 beat loop roll    |
| 6   | Pad     | 2 beat loop roll    |
| 7   | Pad     | 4 beat loop roll    |
| 8   | Pad     | 8 beat loop roll    |

### Pad Scratch Mode

Pad scratch mode is enabled by pressing the PAD SCRATCH button. The button will light up when selected. Press one of the pads to trigger one of the built in scratches.

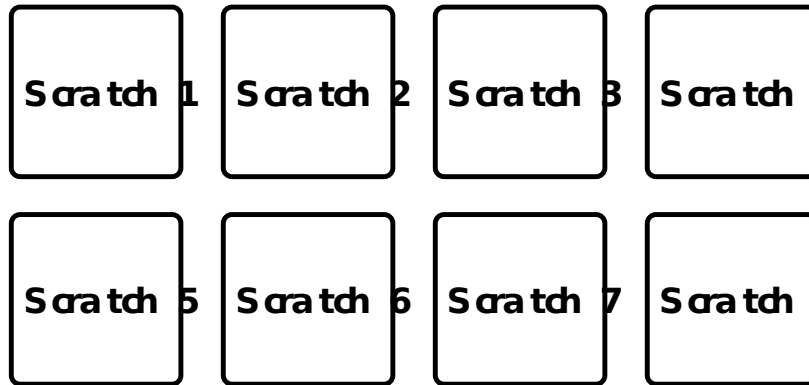

Figure55: Pioneer DDJ-SB3 (performance pads in pad scratch mode)

### Slicer Mode

Slicer mode is enabled by holding SHIFT down and by pressing the PAD SCRATCH button. The button will blink when selected. In this mode every pad represents a marker in the beat grid. Each pad will light up as each slice is played. Press a pad to repeat the slice and hold the pad down to loop it.

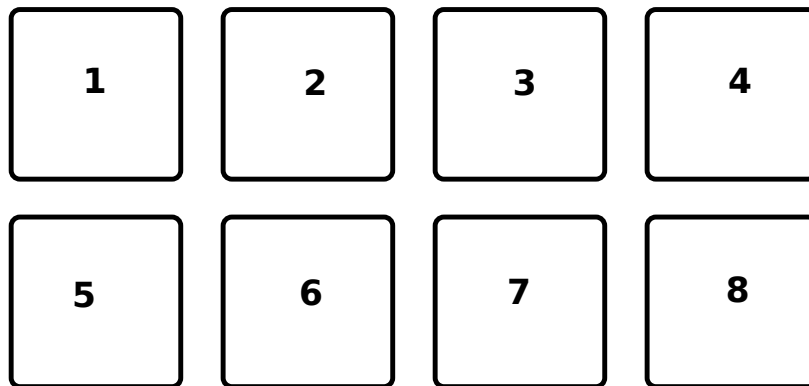

Figure56: Pioneer DDJ-SB3 (performance pads in slicer mode)

## Sampler Mode

Sampler mode is enabled by pressing the SAMPLER button. The button will light up when selected.

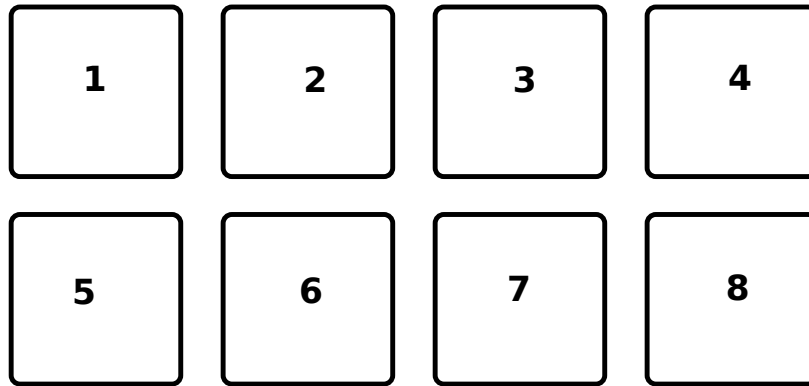

Figure57: Pioneer DDJ-SB3 (performance pads in sampler mode)

| No. | Control     | Function        |
|-----|-------------|-----------------|
| 1   | Pad         | Play sample 1   |
| 1   | SHIFT + Pad | Stop sample 1   |
| 2   | Pad         | Play sample 2   |
| 2   | SHIFT + Pad | Stop sample 2   |
| 3   | Pad         | Play sample 3   |
| 3   | SHIFT + Pad | Stop sample 3   |
| 4   | Pad         | Play sample 4   |
| 4   | SHIFT + Pad | Stop sample 4   |
| 5   | Pad         | Load sample 1   |
| 5   | SHIFT + Pad | Unload sample 1 |
| 6   | Pad         | Load sample 2   |
| 6   | SHIFT + Pad | Unload sample 2 |
| 7   | Pad         | Load sample 3   |
| 7   | SHIFT + Pad | Unload sample 3 |
| 8   | Pad         | Load sample 4   |
| 8   | SHIFT + Pad | Unload sample 4 |

## Trans Mode

Trans mode is enabled by holding SHIFT down and by pressing the SAMPLER button. The button will blink when selected. Press one of the pads to trigger one of the built in cut effects. This mode is driven entirely by the controller's firmware, so there is no equivalent in the Mixxx UI. In this mode, pressing and holding a pad triggers a Cut Effect, where the deck's fader volume is toggle from 0 to max at the rate described in the table below. For example, pressing and holding pad 5 will cause the volume to toggle from max to min every one beat.

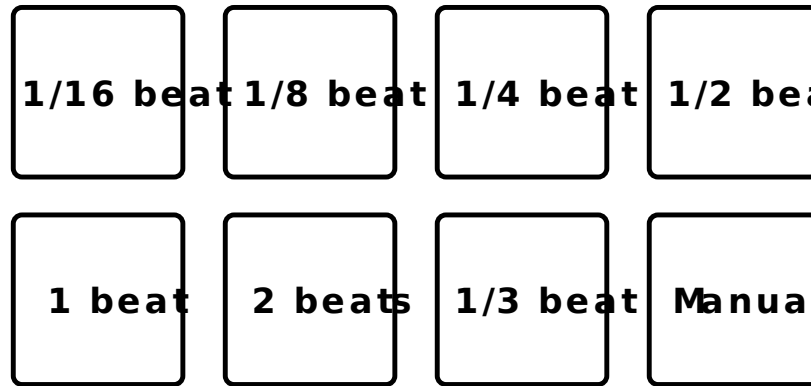

Figure58: Pioneer DDJ-SB3 (performance pads in trans mode)

| No. | Control | Function             |
|-----|---------|----------------------|
| 1   | Pad     | 1/16 beat cut effect |
| 2   | Pad     | 1/8 beat cut effect  |
| 3   | Pad     | 1/4 beat cut effect  |
| 4   | Pad     | 1/2 beat cut effect  |
| 5   | Pad     | 1 beat cut effect    |
| 6   | Pad     | 2 beat cut effect    |
| 7   | Pad     | 1/3 beat cut effect  |
| 8   | Pad     | Manual cut effect    |

### 17.1.98 Pioneer DDJ-SX

The Pioneer DDJ-SX is a 4 deck all-in-one controller that provides intuitive control of all of Mixxx’s features. The DDJ-SX mapping reportedly works with the DDJ-SX2, but it does not use the new features of the DDJ-SX2 hardware.

- [Manufacturer’s product page](#)
- [Forum thread](#)
- [User Manual](#)

Nuovo nella versione 2.1.

#### User Options

To change the mapping’s user options, you have to open the script file (.js). At the top of the file under **\*\*USER OPTIONS\*** the following settings can be made:

- **PioneerDDJSX.jogwheelSensitivity**: Sets the jogwheel sensitivity. 1 = default, 2 is twice as sensitive, 0.5 is half as sensitive.
- **PioneerDDJSX.jogwheelShiftMultiplier**: Sets how much more sensitive the jogwheels get when holding SHIFT. Set it to 1 to disable jogwheel sensitivity increase when holding SHIFT.
- **PioneerDDJSX.twinkleVumeterAutodjOn**: If true, level-meter twinkles if *AutoDJ* is enabled.
- **PioneerDDJSX.autoDJAddTop**: If true, the selected track will be added to *AutoDJ* queue-top on pressing ROTARY SELECTOR, else the selected track will be added to *AutoDJ* queue-bottom.
- **PioneerDDJSX.autoDJTickInterval**: Sets the duration of sleeping between *AutoDJ* actions if *AutoDJ* is enabled [ms].

- **PioneerDDJSX.autoDJMaxBpmAdjustment:** Sets the maximum adjustment of BPM allowed for beats to sync if *AutoDJ* is enabled.
- **PioneerDDJSX.autoDJShuffleAfterSkip:** If true, *AutoDJ* queue is being shuffled after skipping a track.
- **PioneerDDJSX.jumpPreviewEnabled:** If true, by releasing the Rotary Selector, track in preview player jumps forward to `jumpPreviewPosition`.
- **PioneerDDJSX.jumpPreviewPosition:** Sets the preview player absolute position, being set at releasing Rotary Selector and if `jumpPreviewEnabled` enabled.
- **PioneerDDJSX.samplerCueGotoAndPlay:** If true, pad press in SAMPLER PAD MODE repeatedly causes *sampler* to play loaded track from cue-point, else it causes to play loaded track from the beginning.
- **PioneerDDJSX.autoPFL:** If true, PFL / Cue (headphone) is being activated by loading a track into certain deck.



**General Functions**

| Group           | Figure     | Control                         | Description   |
|-----------------|------------|---------------------------------|---|
| 5 - BROWSER     | 2, 3, 4, 5 | LOAD                            | Loads the selected track into the specific deck   |
| 5 - BROWSER     | 2          | SHIFT + LOAD                    | AutoDJ - Toggle BPM sync  |
| 5 - BROWSER     | 3          | SHIFT + LOAD                    | AutoDJ - Toggle Key sync  |
| 5 - BROWSER     | 1          | Rotary Selector                 | Move UP or DOWN the specified number of locations in Library (MoveVertical function)                                |
| 5 - BROWSER     | 1          | Rotary Selector (press)         | Equivalent to double clicking the currently selected item in Library (GoToItem function)                            |
| 5 - BROWSER     | 1          | SHIFT + Rotary Selector         | Move LEFT or RIGHT the specified number of locations in Library (MoveHorizontal function)                           |
| 5 - BROWSER     | 1          | SHIFT + Rotary Selector (press) | Add track from Library to AutoDJ queue at top/bottom (see user options: default = at bottom)                        |
| 5 - BROWSER     | 6          | BACK                            | Currently focused pane changes in Library - previously focused pane will be focused (MoveFocusBackward function)    |
| 5 - BROWSER     | 6          | SHIFT BACK                      | Maximize view of Library  |
| 5 - BROWSER     | 7          | LOAD PREPARE                    | Load selected track into PreviewDeck, jump to position (see user options) and play, else stop already playing track |
| 3 - MIXER       | 1          | Crossfader                      | Controls Mixxx crossfader, fades between deck 1, 3 and 2, 4   |
| 3 - MIXER       | 2          | Channel fader                   | Controls deck volume  |
| 3 - MIXER       | 2          | SHIFT Channel fader             | Fader start (starts playing deck when rising deck volume)   |
| 3 - MIXER       | 3          | TRIM                            | Controls deck gain  |
| 3 - MIXER       | 4          | EQ HIGH                         | Controls deck's equalizer/filter high frequencies   |
| 3 - MIXER       | 5          | EQ MID                          | Controls deck's equalizer/filter mid frequencies  |
| 3 - MIXER       | 6          | EQ LOW                          | Controls deck's equalizer/filter low frequencies  |
| 3 - MIXER       | 7          | CUE                             | Toggles PFL/Cue (headphones) for specific deck  |
| 3 - MIXER       | 7          | SHIFT CUE                       | BPM Tab function for specific deck  |
| 3 - MIXER       | 8          | MASTER LEVEL                    | Controls the master output volume   |
| 3 - MIXER       | 9          | MASTER CUE                      | Toggles master cue  |
| 3 - MIXER       | 9          | SHIFT MASTER CUE                | Toggles split cue (headphones)  |
| 3 - MIXER       | 10         | Crossfader Assign               | Crossfader assignment - deck to crossfader (left (A), right (B) or center (THRU))                                   |
| 3 - MIXER       | 13         | HEADPHONES MIX                  | Controls headphone's audio source (cue, master)   |
| 3 - MIXER       | 14         | SAMPLER VOLUME                  | Controls volume of all available Sampler decks  |
| 3 - MIXER       | 15         | BOOTH MONITOR LEVEL             | Controls the booth output volume  |
| 4 - FRONT PANEL | 1          | Crossfader curve                | Controls Mixxx crossfader curve   |
| 4 - FRONT PANEL | 2          | INPUT SELECT                    | Controls deck source (PC, MIC, CD, PHONO, LINE)   |
| 1 - DECK        | 25         | PANEL SELECT                    | Show/hide Sampler decks / Effect rack   |

**Nota:** The MASTER LEVEL, MASTER CUE, HEADPHONE MIX, BOOTH MONITOR LEVEL and INPUT SELECT controls directly affect the controller's sound card, so adjusting these will not change anything on screen in Mixxx.

## Deck Functions

The controls listed here are documented in Section 1 («Deck») of the owner's manual.

| Figure | Control                     | Description  |
|--------|-----------------------------|--|
| 1      | PLAY/PAUSE                  | Toggles play/pause (hold pressed while playing: starts brake effect -> release: pause track, pr    |
| 1      | SHIFT + PLAY/PAUSE          | Toggles play stutter   |
| 2      | CUE                         | Toggles default cue (sets cue point/ goes to cue point)  |
| 2      | SHIFT + CUE                 | Jump to the beginning of the track and stop  |
| 3      | Jog Wheel (platter)         | Vinyl-Mode enabled: performs scratching when pressed and rotated, Vinyl-Mode disabled: p           |
| 3      | SHIFT + Jog Wheel (platter) | Vinyl-Mode enabled: performs scratching considering user-options multiplier when touched a         |
| 3      | Jog Wheel (side)            | Performs pitch bend when rotated   |
| 3      | SHIFT + Jog Wheel (side)    | Performs pitch bend when rotated considering user-options multiplier                               |
| 4      | TEMPO                       | Controls pitch/tempo ratio   |
| 5      | KEYLOCK                     | Toggles keylock  |
| 5      | SHIFT + KEYLOCK             | Changes TEMPO slider range: Doubles the <i>rateRange</i> , starting from the value set up in the M |
| 5      | KEYLOCK (long press)        | Toggles pitch/tempo reset  |
| 6      | NEEDLE SEARCH               | Jumps to equivalent absolute position in track if track is stopped.                                |
| 6      | SHIFT + NEEDLE SEARCH       | Jumps to equivalent absolute position in track while track is playing.                             |
| 7      | DECK 1                      | Switches left deck to DECK 1 control and illumination  |
| 8      | DECK 2                      | Switches right deck to DECK 2 control and illumination   |
| 9      | DECK 3                      | Switches left deck to DECK 3 control and illumination  |
| 10     | DECK 4                      | Switches right deck to DECK 4 control and illumination   |
| 11     | DUAL DECK                   | Toggles left deck to dual deck control and illumination (DECK 1 and 3)                             |
| 12     | DUAL DECK                   | Toggles right deck to dual deck control and illumination (DECK 2 and 4)                            |
| 13     | SYNC                        | Toggles deck sync  |
| 13     | SHIFT + SYNC                | Toggles quantize function  |
| 14     | AUTO LOOP                   | Set and enable beat loop   |
| 14     | SHIFT AUTO LOOP             | Activates / Deactivates current loop   |
| 15     | LOOP 1/2X                   | Halves active loop   |
| 15     | SHIFT LOOP 1/2X             | Moves active loop one beat backward (left)   |
| 16     | LOOP 2X                     | Doubles active loop  |
| 15     | SHIFT LOOP 2X               | Moves active loop one beat forward (right)   |
| 17     | LOOP IN                     | Toggles loop in  |
| 17     | SHIFT LOOP IN               | Activates current loop, jumps to its loop in point and stops playback.                             |
| 18     | LOOP OUT                    | Toggles loop out   |
| 18     | SHIFT LOOP OUT              | Toggles reloop / exit loop   |
| 19     | VINYL                       | Toggles vinyl (scratch) mode   |
| 20     | CENSOR                      | Toggles reverse roll play  |
| 20     | SHIFT CENSOR                | Toggles reverse play   |
| 21     | SLIP                        | Toggles slip mode  |
| 22     | GRID ADJUST                 | Hold and touch/rotate Jog dial to adjust beats faster/slower                                       |
| 22     | SHIFT GRID ADJUST           | Set/translate beat grid to current track position (adjust position with Jog dial)                  |
| 23     | GRID SLIDE                  | Hold and touch/rotate Jog dial to set/translate beat grid earlier/later                            |
| 24     | SHIFT                       | Switches to shifted controls, no direct function   |

## Performance Pads

The performance pads support multiple different modes. The controls listed here are documented in Section 6 («Performance Pads») of the owner’s manual.

| Figure | Control                   | Description   |
|--------|---------------------------|---|
| 9      | HOT CUE mode              | Switches pad control and illumination to <i>HOT CUE mode</i>  |
| 10     | ROLL mode                 | Switches pad control and illumination to <i>BEATLOOP ROLL mode</i>  |
| 10     | SHIFT + ROLL mode         | Switches pad control and illumination to <i>GROUP2 (BEATLOOP) mode</i>  |
| 11     | SLICER mode               | Switches pad control and illumination to <i>SLICER mode</i> , in SLICER mode switches between continuous slice mode and loop slice mode |
| 12     | SAMPLER mode              | Switches pad control and illumination to <i>SAMPLER mode</i>  |
| 12     | SAMPLER mode (long press) | Toggles sampler pad velocity mode (velocity ~ volume)   |

## HOT CUE Mode

| Figure | Control                 | Description                              |
|--------|-------------------------|--|
| 1      | PAD 1                   | Set/activate Hot cue 1                   |
| 1      | SHIFT + PAD 1           | Clear Hot cue 1                          |
| 2      | PAD 2                   | Set/activate Hot cue 2                   |
| 2      | SHIFT + PAD 2           | Clear Hot cue 2                          |
| 3      | PAD 3                   | Set/activate Hot cue 3                   |
| 3      | SHIFT + PAD 3           | Clear Hot cue 3                          |
| 4      | PAD 4                   | Set/activate Hot cue 4                   |
| 4      | SHIFT + PAD 4           | Clear Hot cue 4                          |
| 5      | PAD 5                   | Set/activate Hot cue 5                   |
| 5      | SHIFT + PAD 5           | Clear Hot cue 5                          |
| 6      | PAD 6                   | Set/activate Hot cue 6                   |
| 6      | SHIFT + PAD 6           | Clear Hot cue 6                          |
| 7      | PAD 7                   | Set/activate Hot cue 7                   |
| 7      | SHIFT + PAD 7           | Clear Hot cue 7                          |
| 8      | PAD 8                   | Set/activate Hot cue 8                   |
| 8      | SHIFT + PAD 8           | Clear Hot cue 8                          |
| 13     | PARAMETER LEFT          | Jump <i>beatjump_size</i> beats backward |
| 13     | SHIFT + PARAMETER LEFT  | Increase <i>beatjump_size</i>            |
| 14     | PARAMETER RIGHT         | Jump <i>beatjump_size</i> beats forward  |
| 14     | SHIFT + PARAMETER RIGHT | Decrease <i>beatjump_size</i>            |

## BEATLOOP ROLL Mode

By using the PARAMETER LEFT and PARAMETER RIGHT buttons in BEATLOOP ROLL (default parameter set: 2), you can change the pad-assigned loop size. The following table shows the possible assignments (unit: beats).

| Set No. | Pad 1 | Pad 2 | Pad 3 | Pad 4 | Pad 5 | Pad 6 | Pad 7 | Pad 8 |
|---------|-------|-------|-------|-------|-------|-------|-------|-------|
| 0       | 1/4   | 1/2   | 1     | 2     | 4     | 8     | 16    | 32    |
| 1       | 1/8   | 1/4   | 1/2   | 1     | 2     | 4     | 8     | 16    |
| 2       | 1/16  | 1/8   | 1/4   | 1/2   | 1     | 2     | 4     | 8     |
| 3       | 1/32  | 1/16  | 1/8   | 1/4   | 1/2   | 1     | 2     | 4     |

| Figure | Control         | Description   |
|--------|-----------------|---|
| 1      | PAD 1           | Toggle Beatloop roll length index 1 (according parameter set)   |
| 2      | PAD 2           | Toggle Beatloop roll length index 2 (according parameter set)   |
| 3      | PAD 3           | Toggle Beatloop roll length index 3 (according parameter set)   |
| 4      | PAD 4           | Toggle Beatloop roll length index 4 (according parameter set)   |
| 5      | PAD 5           | Toggle Beatloop roll length index 5 (according parameter set)   |
| 6      | PAD 6           | Toggle Beatloop roll length index 6 (according parameter set)   |
| 7      | PAD 7           | Toggle Beatloop roll length index 7 (according parameter set)   |
| 8      | PAD 8           | Toggle Beatloop roll length index 8 (according parameter set)   |
| 13     | PARAMETER LEFT  | Decrement active looproll-interval parameter set (0-3), button LED is illuminated at parameter set 2, 3 |
| 14     | PARAMETER RIGHT | Increment active looproll-interval parameter set (0-3), button LED is illuminated at parameter set 1, 3 |

## SLICER Mode

For a detailed explanation of the slicer mode, take a look at the controller's manual. A limited slicer functionality is implemented into the controller mapping as described below.

There are two slicer modes, continuous slice and loop slice, which can be selected by pressing the SLICER mode button. If none or only one pad (beat) is lit, continuous slice mode is active. If you press SLICER mode button again, loop slice mode will be activated and all pads, except one for the beat, will light up.

Starting with the first beat marked on a playing track, the track is divided into sections of 8 equal parts (not visible in waveform). If the first 8 parts are reached, the next section starts. The pads are assigned to one section, each time the active section changes, the pads will be assigned to the new active section (pad 1..8 = section part 1..8). The section size is dependent of the selected slicer domain, changeable by pressing SHIFT + PARAMETER LEFT or PARAMETER RIGHT. The default slicer domain is 8 beats, so each part represents the part between one beat and the following beat. Possible slicer domains are 8, 16, 32, 64 beats.

| Figure | Control                 | Description   |
|--------|-------------------------|---|
| 1      | PAD 1                   | Press: Jumps to beat position 1 in 8-beat-section and beat loops according quantization index (default: 1/4 beat), Release (continuous slice only): Jumps to actual play position in the background (slip). |
| 2      | PAD 2                   | Press: Jumps to beat position 2 in 8-beat-section and beat loops according quantization index (default: 1/4 beat), Release (continuous slice only): Jumps to actual play position in the background (slip). |
| 3      | PAD 3                   | Press: Jumps to beat position 3 in 8-beat-section and beat loops according quantization index (default: 1/4 beat), Release (continuous slice only): Jumps to actual play position in the background (slip). |
| 4      | PAD 4                   | Press: Jumps to beat position 4 in 8-beat-section and beat loops according quantization index (default: 1/4 beat), Release (continuous slice only): Jumps to actual play position in the background (slip). |
| 5      | PAD 5                   | Press: Jumps to beat position 5 in 8-beat-section and beat loops according quantization index (default: 1/4 beat), Release (continuous slice only): Jumps to actual play position in the background (slip). |
| 6      | PAD 6                   | Press: Jumps to beat position 6 in 8-beat-section and beat loops according quantization index (default: 1/4 beat), Release (continuous slice only): Jumps to actual play position in the background (slip). |
| 7      | PAD 7                   | Press: Jumps to beat position 7 in 8-beat-section and beat loops according quantization index (default: 1/4 beat), Release (continuous slice only): Jumps to actual play position in the background (slip). |
| 8      | PAD 8                   | Press: Jumps to beat position 8 in 8-beat-section and beat loops according quantization index (default: 1/4 beat), Release (continuous slice only): Jumps to actual play position in the background (slip). |
| 13     | PARAMETER LEFT          | Decrement active slicer quantization (1/8, 1/4, 1/2, 1 beat loop), button LED is illuminated at quantization 1/2, 1   |
| 13     | SHIFT + PARAMETER LEFT  | Decrement active slicer domain (8, 16, 32, 64 beats), button LED is illuminated at domain 32, 64  |
| 14     | PARAMETER RIGHT         | Increment active slicer quantization (1/8, 1/4, 1/2, 1 beat loop), button LED is illuminated at quantization 1/4, 1   |
| 14     | SHIFT + PARAMETER RIGHT | Increment active slicer domain (8, 16, 32, 64 beats), button LED is illuminated at domain 16, 64  |

### Continuous slice mode

The pad lights show the active part in the active section: The active part pad is lit, all other pad lights are off.

Continuous slice mode moves to the next section if the end of the previous active section is reached.

By pressing pad X, the play position jumps to the beat X of the active section. If you have pressed the pad on-beat and hold it, the play position is playing in loop. The beat loop length depends on the selected slicer quantization (changeable by pressing PARAMETER LEFT or PARAMETER RIGHT). If you release the pad, the playback will resume where the track would have been if the slicer wouldn't have been activated (slip mode).

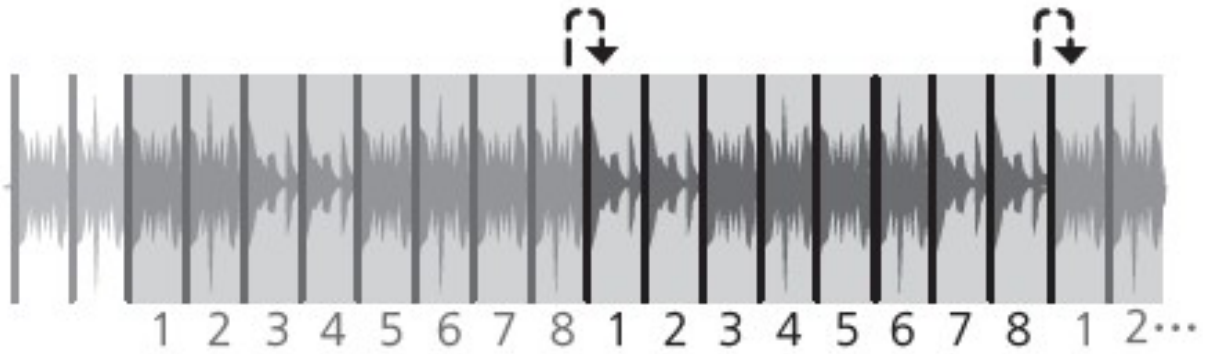

Figure59: Pioneer DDJ SX Slicer (type 1)

### Loop slice mode

The pad lights show the active part in the active section: The active part pad light is off, all other pads are lit.

As soon as loop slice mode is activated, the active section is played in loop (not visible in waveform). If the end of the active section is reached, the play position jumps back to the beginning of the active section.

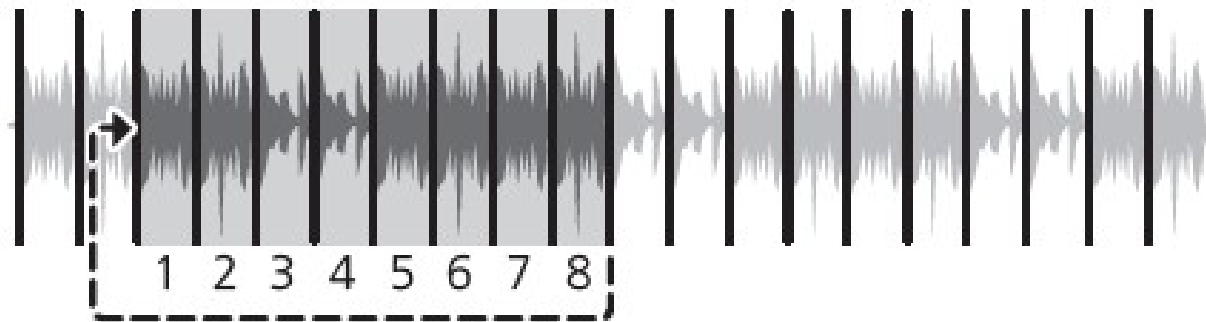

Figure60: Pioneer DDJ SX Slicer (type 2)

By pressing pad X, the play position jumps to the beat X of the active section. In loop slice mode beat loop is not possible.

As soon as loop slice mode is deactivated (by pressing SLICER mode button again), the playback will resume where the track would have been if the slicer wouldn't have been activated (slip mode).



**SAMPLER Mode**

| Figure                   | Control               | Description  |
|--------------------------|-----------------------|--|
| 1                        | PAD 1                 | Sample deck index 1 (according sampler bank) - empty: Load selected track into sample deck, track loaded: start play (default, see user options) sample deck   |
| 1                        | SHIFT + hwlabel:PAD 1 | Sample deck index 1 (according sampler bank) - playing: stop deck, stopped: eject track  |
| 2                        | PAD 2                 | Sample deck index 2 (according sampler bank) - empty: Load selected track into sample deck, track loaded: start play (default, see user options) sample deck   |
| 2                        | SHIFT + hwlabel:PAD 2 | Sample deck index 2 (according sampler bank) - playing: stop deck, stopped: eject track  |
| 3                        | PAD 3                 | Sample deck index 3 (according sampler bank) - empty: Load selected track into sample deck, track loaded: start play (default, see user options) sample deck   |
| 3                        | SHIFT + hwlabel:PAD 3 | Sample deck index 3 (according sampler bank) - playing: stop deck, stopped: eject track  |
| 4                        | PAD 4                 | Sample deck index 4 (according sampler bank) - empty: Load selected track into sample deck, track loaded: start play (default, see user options) sample deck   |
| 4                        | SHIFT + hwlabel:PAD 4 | Sample deck index 4 (according sampler bank) - playing: stop deck, stopped: eject track  |
| 5                        | PAD 5                 | Sample deck index 5 (according sampler bank) - empty: Load selected track into sample deck, track loaded: start play (default, see user options) sample deck   |
| 5                        | SHIFT + hwlabel:PAD 5 | Sample deck index 5 (according sampler bank) - playing: stop deck, stopped: eject track  |
| 6                        | PAD 6                 | Sample deck index 6 (according sampler bank) - empty: Load selected track into sample deck, track loaded: start play (default, see user options) sample deck   |
| 6                        | SHIFT + hwlabel:PAD 6 | Sample deck index 6 (according sampler bank) - playing: stop deck, stopped: eject track  |
| 7                        | PAD 7                 | Sample deck index 7 (according sampler bank) - empty: Load selected track into sample deck, track loaded: start play (default, see user options) sample deck   |
| 7                        | SHIFT + hwlabel:PAD 7 | Sample deck index 7 (according sampler bank) - playing: stop deck, stopped: eject track  |
| 8                        | PAD 8                 | Sample deck index 8 (according sampler bank) - empty: Load selected track into sample deck, track loaded: start play (default, see user options) sample deck   |
| 8                        | SHIFT + hwlabel:PAD 8 | Sample deck index 8 (according sampler bank) - playing: stop deck, stopped: eject track  |
| 13                       | PARAMETER             | Decrement active sampler bank (0-3), button LED is illuminated at sampler bank 2, 3. Sampler bank 0: sampler 1-8, sampler bank 1: sampler 9-16 sampler bank 2: sampler 17-24, sampler bank 3: sampler 25-32  |
| <b>17.1. Controllers</b> |                       | <b>398</b>   |
| 14                       | PARAMETER LEFT RIGHT  | Increment active sampler bank (0-3), button LED is illuminated at sampler bank 1, 3. Sampler bank 0: sampler 1-8, sampler bank 1: sampler 9-16, sampler bank 2: sampler 17-24, sampler bank 3: sampler 25-32 |



## BEATLOOP Mode (GROUP2)

By using the PARAMETER LEFT and PARAMETER RIGHT buttons in BEATLOOP mode (default parameter set: 0), you can change the pad-assigned loop size. The following table shows the possible assignments (unit: beats).

| Set No. | Pad 1 | Pad 2 | Pad 3 | Pad 4 | Pad 5 | Pad 6 | Pad 7 | Pad 8 |
|---------|-------|-------|-------|-------|-------|-------|-------|-------|
| 0       | 1/4   | 1/2   | 1     | 2     | 4     | 8     | 16    | 32    |
| 1       | 1/8   | 1/4   | 1/2   | 1     | 2     | 4     | 8     | 16    |
| 2       | 1/16  | 1/8   | 1/4   | 1/2   | 1     | 2     | 4     | 8     |
| 3       | 1/32  | 1/16  | 1/8   | 1/4   | 1/2   | 1     | 2     | 4     |

| Figure | Control         | Description   |
|--------|-----------------|---|
| 1      | PAD 1           | Toggle Beatloop length index 1 (according parameter set)  |
| 2      | PAD 2           | Toggle Beatloop length index 2 (according parameter set)  |
| 3      | PAD 3           | Toggle Beatloop length index 3 (according parameter set)  |
| 4      | PAD 4           | Toggle Beatloop length index 4 (according parameter set)  |
| 5      | PAD 5           | Toggle Beatloop length index 5 (according parameter set)  |
| 6      | PAD 6           | Toggle Beatloop length index 6 (according parameter set)  |
| 7      | PAD 7           | Toggle Beatloop length index 7 (according parameter set)  |
| 8      | PAD 8           | Toggle Beatloop length index 8 (according parameter set)  |
| 13     | PARAMETER LEFT  | Decrement active loop-interval parameter set (0-3), button LED is illuminated at parameter set 2, 3 |
| 14     | PARAMETER RIGHT | Increment active loop-interval parameter set (0-3), button LED is illuminated at parameter set 1, 3 |

## Effect Functions

This controller mapping uses the [standard Mixxx mapping for effects sections on controllers](#). The controls listed here are documented in Section 2 («Effects») of the owner's manual.

| Figure         | Control                   | Description   |
|----------------|---------------------------|---|
| 1 (L)          | FX1-1                     | Focused effect none: Controls EffectRack1-EffectUnit1/3-Effect1 meta, Focused effect 1..3: Controls effect parameter 1 of effect in EffectRack1-EffectUnit1/3         |
| 1 (L)          | SHIFT + FX1-1             | Controls effect selection for EffectRack1-EffectUnit1/3 effect 1  |
| 1 (R)          | FX2-1                     | Focused effect none: Controls EffectRack1-EffectUnit2/4-Effect1 meta, Focused effect 1..3: Controls effect parameter 1 of focused effect in EffectRack1-EffectUnit2/4 |
| 1 (R)          | SHIFT + hwlabel:FX2-1     | Controls effect selection for EffectRack1-EffectUnit2/4 effect 1  |
| 2 (L)          | FX1-2                     | Focused effect none: Controls EffectRack1-EffectUnit1/3-Effect2 meta, Focused effect 1..3: Controls effect parameter 2 of focused effect in EffectRack1-EffectUnit1/3 |
| 2 (L)          | SHIFT + hwlabel:FX1-2     | Controls effect selection for EffectRack1-EffectUnit1/3 effect 2  |
| 2 (R)          | FX2-2                     | Focused effect none: Controls EffectRack1-EffectUnit2/4-Effect2 meta, Focused effect 1..3: Controls effect parameter 2 of focused effect in EffectRack1-EffectUnit2/4 |
| 2 (R)          | SHIFT + hwlabel:FX2-2     | Controls effect selection for EffectRack1-EffectUnit2/4 effect 2  |
| 3 (L)          | FX1-3                     | Focused effect none: Controls EffectRack1-EffectUnit1/3-Effect3 meta, Focused effect 1..3: Controls effect parameter 3 of focused effect in EffectRack1-EffectUnit1/3 |
| 3 (L)          | SHIFT + hwlabel:FX1-3     | Controls effect selection for EffectRack1-EffectUnit1/3 effect 3  |
| 3 (R)          | FX2-3                     | Focused effect none: Controls EffectRack1-EffectUnit2/4-Effect3 meta, Focused effect 1..3: Controls effect parameter 3 of focused effect in EffectRack1-EffectUnit2/4 |
| 3 (R)          | SHIFT + hwlabel:FX2-3     | Controls effect selection for EffectRack1-EffectUnit2/4 effect 3  |
| 4 (L)          | FX1 BEATS                 | Controls EffectRack1-EffectUnit1/3 mix  |
| 4 (R)          | FX2 BEATS                 | Controls EffectRack1-EffectUnit2/4 mix  |
| 4 (L)          | SHIFT + hwlabel:FX1 BEATS | Controls EffectRack1-EffectUnit1/3 super1 knob  |
| 4 (R)          | SHIFT + hwlabel:FX2 BEATS | Controls EffectRack1-EffectUnit2/4 super1 knob  |
| 5 (L)          | FX1-1 ON                  | EffectFocusButton press and hold: focus EffectRack1-EffectUnit1/3-Effect1, else: Toggles EffectRack1-EffectUnit1/3-Effect1  |
| 5 (R)          | FX2-1 ON                  | EffectFocusButton press and hold: focus EffectRack1-EffectUnit2/4-Effect1, else: Toggles EffectRack1-EffectUnit2/4-Effect1  |
| 6 (L)          | FX1-2 ON                  | EffectFocusButton press and hold: focus EffectRack1-EffectUnit1/3-Effect2, else: Toggles EffectRack1-EffectUnit1/3-Effect2  |
| 6 (R)          | FX2-2 ON                  | EffectFocusButton press and hold: focus EffectRack1-EffectUnit2/4-Effect2, else: Toggles EffectRack1-EffectUnit2/4-Effect2  |
| 7 (L)          | FX1-3 ON                  | EffectFocusButton press and hold: focus EffectRack1-EffectUnit1/3-Effect3, else: Toggles EffectRack1-EffectUnit1/3-Effect3  |
| 7 (R)          | FX2-3 ON                  | EffectFocusButton press and hold: focus EffectRack1-EffectUnit2/4-Effect3, else: Toggles EffectRack1-EffectUnit2/4-Effect3  |
| 8 (L)          | FX1 TAP                   | EffectFocusButton of EffectRack1-EffectUnit1/3  |
| 8 (R)          | FX2 TAP                   | EffectFocusButton of EffectRack1-EffectUnit2/4  |
| 8 (L)          | SHIFT + hwlabel:FX1 TAP   | Switch EffectUnit 1 <-> 3   |
| 8 (R)          | SHIFT + hwlabel:FX2 TAP   | Switch EffectUnit 2 <-> 4   |
| 9, 10, 11, 12  | FX1 ASSIGN                | Assign EffectRack1-EffectUnit1/3 to specific deck   |
| 13, 14, 15, 16 | FX2 ASSIGN                | Assign EffectRack1-EffectUnit2/4 to specific deck   |
| 17, 18,        | FILTER                    | Control QuickEffectRack1 super1 knob (e.g. moog filter)   |

## Troubleshooting

If you experience any strange behavior of a button or a LED (e.g. wheel LEDs not working), make sure your controller is set up correctly to work with Mixxx. The DDJ-SX provides several settings, which can be changed in a special *Utility-Mode*.

### Utility-Mode

- Disconnect USB-cable.
- Switch off STANDBY/ON the unit.
- Hold SHIFT button and PLAY/PAUSE button at the left deck while switching on the unit STANDBY/ON.
- Now *Utility-Mode* is activated.
- For saving and exiting *Utility-Mode*, switch off the unit again STANDBY/ON.

### Setting for usage of Serato DJ

To use the DDJ-SX with Mixxx, the controller must be configured for the usage of Serato DJ. You can check/change this setting by pressing the KEY LOCK button at the left deck.

- KEY LOCK button off: Controller is configured for using Serato DJ (default).
- KEY LOCK button on (lit): Controller is configured for using different DJ-software.

## 17.1.99 Reloop Beatmix 2

The **Reloop Beatmix 2** is a performance-oriented 2-channel pad controller with integrated soundcard. **Beatmix 2** offers an ergonomically designed 2-channel mixer layout, optimized for the club allowing you to work intuitively: Dedicated equalizer and gain dials, high-quality line-faders, an extremely smooth-running crossfader, 16 multi-colour drum pads, as well as two extensive FX units are the foundation for your creativity.

This controller is a midi and audio class compliant device so it is compatible as-is with Linux, MacOS and Windows. However, on Windows, the manufacturer ship an ASIO low-latency driver that can be found on the [manufacturer's product page](#).

The mapping for the *Reloop Beatmix 4* should be compatible with this controller, but hasn't been tested. See the *Reloop Beatmix 4* page for the complete mapping description.

- [Manufacturer's product page](#)
- [Forum thread](#)

Nuovo nella versione 2.1.

### 17.1.100 Reloop Beatmix 4

The Reloop Beatmix 4 is a performance-oriented 4-channel pad controller with integrated soundcard. It offers an ergonomically designed 4-channel mixer layout, optimized for the club allowing you to work intuitively: Dedicated equalizer and gain dials, high-quality line-faders, an extremely smooth-running crossfader, 16 multi-colour drum pads, as well as two extensive FX units are the foundation for your creativity.

- [Manufacturer's product page](#)
- [Forum thread](#)

Nuovo nella versione 2.1.

#### Audio

This controller is a MIDI and audio class compliant device so it is compatible as-is with Linux, MacOS and Windows. On windows, the manufacturer ships an *ASIO* low-latency driver that can be found on the [Manufacturer's product page](#).

The MIC input is hardware-mixed and is not digitized so Mixxx can not have any control on the mic and you can not use ducking in Mixxx. The MASTER volume and PHONES volume knobs directly control hardware and don't change Mixxx controls.

#### Mixer Section

| Control                  | Description   |
|--------------------------|---|
| MASTER                   | Controls the master volume to your main sound system. This controls the built in sound card and has no effect on the master gain knob in Mixxx. |
| PHONES                   | Controls your headphones volume. This controls the built in sound card and has no effect on the headphone gain knob in Mixxx.                   |
| CUE MIX                  | Mixes the headphones CUE signal between your selected channel and the master output.  |
| TRAX SELECT              | Use the <i>Trax selector</i> to navigate through your song library.   |
| TRACK LOAD (short press) | Load tracks on either channel. These buttons are lit when a track is loaded into the associated deck.   |
| TRACK LOAD (long press)  | Eject the selected deck.  |
| SHIFTTRACK LOAD          | Enable and launch a track using your linefader (FADER-START, hardware function)   |
| CUE                      | Pre-listen the selected channel in your headphones. This buttons lights-up when activated   |
| BACK                     | Switch <i>Trax action</i> between playlists (sidebar), tracks and Preview Deck.   |
| SAMPLER VOLUME           | Controls the volume of all samplers.  |
| LINE FADERS              | Controls your channel volume.   |
| CROSSFADER               | Enables you to fade between your decks.   |
| GAIN                     | Adjust the gain for each deck.  |
| EQ                       | Tweak the high, mid or low frequencies when mixing your track.  |
| DECK                     | Press the deck button to swap between decks 1 & 3 on the left and 2 & 4 on the right.   |

**Suggerimento:** You can replace the fader cap of the SAMPLER VOLUME fader with a custom colored fader cap to make it visually stand out from the channel volume faders.

## Trax selector and Back button

The trax selector let you navigate through your library (playlist and tracks) as well as preview tracks.

The trax selector has three modes:

**Track mode (default)** Turning the trax selector will select tracks (one by one), turning with shift will select tracks faster (10 by 10). Pressing the Back button will switch to Playlist mode and pushing the trax selector will load the selected track into the preview deck, start playing and switch to Preview mode.

**Playlist mode** Turning the trax selector will select sidebar item (one by one), turning with shift will select sidebar item faster (10 by 10). Pressing the trax selector will expand/collapse the selected sidebar item and pressing the Back button will return to Track mode.

**Preview mode** Turning the trax selector let you navigate through the track loaded in the PreviewDeck (faster with shift), pushing the trax selector will play/pause the preview deck and pushing the back button return to Track mode.

## Transport Section

| Control               | Description  |
|-----------------------|--|
| PLAY/PAUSE            | Press to launch and pause your track.  |
| SHIFT +<br>PLAY/PAUSE | Reverses the direction of the track playing.   |
| CUE                   | Sets a temporary <i>cue point</i> . It is set by pausing the track and pressing the CUE button. While the track is playing, press the button to return to that point, where it will pause. |
| SHIFT +<br>CUE        | Takes you back to the start of your track.   |
| CUP                   | Takes you directly to your cue point and starts playback instantly. If no cue point is set, it will jump to the beginning of the track.  |
| SHIFT +<br>CUP        | Changes the pitch range, cycling through 8%, 10%, 12% and 16%  |
| SYNC                  | Syncs the BPM and phase to that of the other track (if <i>BPM</i> is detected on both).  |
| SHIFT +<br>SYNC       | Turn on master sync, keeping sync enabled  |

## Jog wheel and pitch slider

Touch and move the jog wheel to scratch (either deck playing or not).

When playing, use the side of the wheel, without touching the metallic platter, to temporarily bend the pitch (speed up/slow down playback). When the deck is not playing, using the side of the wheel let you quick search through your track.

Hold SHIFT and turn the jog wheel to quick search through your track. SHIFT ignores touch sensitive platter so holding it and turning jogwheel is the same as using the side of the jog wheel.

When a deck is playing, jog led will turn around at 33.3 RPM. When track time left is below 30 seconds, jog leds will blink slowly, and when track time remaining is below 15 seconds, jog leds will blink quickly. These delays can be changed by editing the two variables at the beginning of the JavaScript file and eventually set to -1 to disable jog led blink.

The pitch slider let you adjust pitch.

PITCH +/- buttons let you temporarily adjust the the speed one step higher/lower. These buttons, when used with shift, let you *control effects*.

## Effects Section

The effect section let you control the first two EffectUnits. There are two different effect modes mapped:

- Multi Effect mode (the default), where you can load up to three effects in each EffectUnit and control then with the super knob
- Single Effect mode, where you can load a single effect in the Effect Unit and control the first 6 parameters

| Control              | Multi Effect mode             | Single Effect mode  |
|----------------------|-------------------------------|---------------------|
| FX1                  | Turn left to disable effect 1 | Effect parameter 1  |
| FX2                  | Turn left to disable effect 2 | Effect parameter 2  |
| FX3                  | Turn left to disable effect 3 | Effect parameter 3  |
| SHIFT + FX1          | select effect 1               | Effect parameter 4  |
| SHIFT + FX2          | select effect 2               | Effect parameter 5  |
| SHIFT + FX3          | select effect 3               | Effect parameter 6  |
| BEATS (turn)         | SuperKnob                     | dry/wet knob        |
| BEATS (push)         | Toggle Effect Unit            |                     |
| SHIFT + Beats (turn) | Dry/Wet knob                  | Select Effect Chain |
| SHIFT + Beats (push) | Eject Effect Chain            |                     |

You can choose which deck you want to apply EffectUnit 1 and 2 by pressing SHIFT + PITCHBEND - / SHIFT + PITCHBEND + on that deck (short press).

To switch from Single Effect mode to Multi Effect mode, hold down SHIFT and press PITCHBEND - for more than a second to switch to “Single Effect mode” or PITCHBEND + for more than a second to switch to “Multi Effect mode”. The corresponding led will blink three times, indicating which mode you switched to.

## Pad Section

### Mode A - Cue points and Loops

| Control                     | Description  |
|-----------------------------|--|
| Pads 1-4 (top row)          | Press an unlit pad to set a new <i>cue point</i> . If it is already set, jump to this cue point. |
| SHIFT + Pads 1-4 (top row)  | Deletes cue points.  |
| Pads 5-8 (bottom row)       | Press the pad to activate a loop. Loop length (in beats) is respectively 1, 2, 4 and 8 beats.    |
| SHIFT + Pads 5 (bottom row) | Sets a loop length. Push to define loop start, release to define loop end.                       |
| SHIFT + Pads 6 (bottom row) | Shortens (half) the loop.  |
| SHIFT + Pads 7 (bottom row) | Lengthens (double) the loop.   |
| SHIFT + Pads 8 (bottom row) | Replays the loop.  |

## Mode B - Samplers

Mode B let you control 8 samplers. Top row is for sampler 1-4 and bottom row is for sampler 5-8, each sampler controlled by a pad button.

Press an unlit pad to load the track selected in the library to that sampler. Pads are red when the sampler is loaded but not playing and purple when playing.

Press a red pad to play the sample from its cue point. Press a purple pad to jump back to the sample's cue point.

Press a purple pad with shift to stop a playing sample. Press a red pad with shift to eject a sample.

## Split mode

Split mode is activated by pressing mode A and mode B buttons simultaneously. The two leds A and B are lit together. In this mode, top row is configured in mode A, and the bottom row if configured as the top row of mode B.

So in this mode, you can control 4 cue points and 4 samplers.

### 17.1.101 Reloop Beatpad

The **Reloop Beatpad** is a conventional 2 channel controller that is primarily designed to work with algoriddim's djay on the iOS platform and more recently on the Android platform, but can also be used with Mixxx by sending MIDI signals to a computer with a USB cable.

- [Manufacturer's product page](#)
- [Forum thread](#)

Nuovo nella versione 2.0.

## Mixer Section

### Crossfader

Blends audio between left and right mixer channels.

### Volume Faders

Adjust the Volume of each channel. If *Fader Start <reloop-beatpad-trackselect>* is enabled the deck will stop at the previously used Cue if the Volume Fader reaches the minimum position and will start playing if the Volume fader moves from the minimum position.

## 1 and 2 (Track select buttons)

- **Load a track:** Press these buttons to load the selected track from the Browser to left or right deck. The LED of the button will be on if the deck is loaded.
- **Eject:** Hold the same button for more than half of a second to unload the same deck.
- **Fader Start:** Hold *SHIFT* down and then press one of these buttons to enable the **Fader Start** on a deck. The LED of the button will blink if Fader Start is enabled. If Fader Start is enabled the deck will stop at the previously used Cue if the Volume Fader reaches the minimum position and will start playing if the Volume fader moves from the minimum position.

## PFL (symbolized by a headphone)

- **\*\*PFL:** \*\*Press these buttons to send each channel to the Headphones Output channel for pre-listening.
- **\*\*Slip mode:** \*\*Hold *SHIFT* down and then press these buttons to activate/deactivate Slip Mode. When active, the playback continues muted in the background during a loop, scratch etc. Once disabled, the audible playback will resume where the track would have been.
- **Quantize mode:** Hold *SHIFT* down and then press these buttons to activate/deactivate the Quantize mode. When active, it aligns Hot-cues and Loops to the next beat from the current position.

## Equalizer

- **LOW:** Adjust the Low (Bass) frequencies for each mixer channel.
- **MID:** Adjust the Mid frequencies for each mixer channel.
- **HIGH:** Adjust the High (Treble) frequencies for each mixer channel.
- **GAIN:** Adjust the Gain of each mixer channel.
- **MASTER:** Adjust the level of the Master Output.
- **Cue Mix (Headphones mixing):** Adjust how the Channels and the Master Output blend at the Headphones Channel.
- **Phones (Headphones level):** Adjust the Volume Output of the Headphones Channel.
- **AUX:** Adjust the Volume of the AUX Input.

The MASTER, Phones, and AUX knobs adjust the levels of the Beatpad's sound card; they do not control the software gains in Mixxx so the changes are not visible on screen.

## REC

- **Record:** Use this button to start/stop recording your mixing session.
- **End track warning:** Hold *SHIFT* down and then press this button in order to toggle **on** or **off** the red flashing of the *jog wheels* when the playback reaches the end of the track.



## Browse Knob

Scroll through your library.

- **Turn** to select a track in the song list.
- **Push** to load the selected track into first stop deck.
- **SHIFT+Turn** to select a folder or subfolder in the left item list sidebar.
- **SHIFT+Push** to open/close folders and subfolders in the left item list sidebar.

## Deck Controls Section

### SHIFT

Press and hold one of those buttons to access secondary functions of other controls on the Beatpad. The secondary functions can be accessed while the **SHIFT** button is held down. If the **SHIFT LOCK** switch on the back side of the Reloop Beatpad is on, the secondary functions can be accessed after the button **SHIFT** button is released and until the **SHIFT** is pressed again.

### PLAY/PAUSE

- **Play/pause:** Press to play/pause the track. If there was no track loaded into the deck and a track is selected in the library, it is loaded and starts playing.
- **Censor:** Hold *SHIFT* down and then press this button to play the track in reverse. When released the track will continue to play from the position it would have been if the button was never pressed. In other words, it enables reverse and slip mode while held.

### JUMP

- **While playing, or stopped:** If the Cue point is set, seeks the player to it and starts playback.
- **Brake:** Hold *SHIFT* down and then press this button to stop the track with a gradual brake. If the **JUMP** button is released before the track has completely stopped, the track is then played back to its regular speed.
- **Spinback:** see the *Instant FX* usage.

### SET

- **While playing:** Seeks the track to the cue-point and stops.
- **While stopped:** Sets the cue point (Pioneer/Mixxx mode) OR preview from it (Denon mode). If the Cue point is already set at the current position of the track, hold this button to play the track and release it to return to the Cue point and pause it. To continue playback without returning to the Cue Point, press and hold the **SET** Button, then press and hold the *Play/Pause* Button and then release both buttons.
- **Key lock:** Hold *SHIFT* down and then press this button to enable/disable the Key-lock.

---

**Suggerimento:** Change the default cue mode in Preferences -> Interface. The Pioneer mode is the more consistent with the Reloop Beatpad.

---

## SYNC

- **Press once** to synchronize the tempo (BPM) and phase to that of the other track.
- **Press twice quickly** to play the track immediately, synchronized to the tempo (BPM) and to the phase of the other track, if the track was paused.
- **Sync Lock:** Hold for at least half of a second to enable **sync lock** for this deck. Decks with sync locked will all play at the same tempo, and decks that also have **quantize** enabled (which is enabled by default by the mapping) will always have their beats lined up. **Note :** the **quantize** mode is not mapped on the controller but can be enabled/desabled from Mixxx.

## Jogwheel

Touch sensitive platters for scratching (Scratch mode/iCut mode), bending (Scratch mode/CD mode) or Seek mode. The jogwheel offers multi-color leds, which will show the playing marker (Scratch mode), the song progress bar (in Seek mode), and other colored combinations depending on the applied effect, loop, loop roll or Filter. If no track is loaded, the jogwheel displays a red cross. At the end of a track, the jogwheel is flashing red faster and faster until it reaches the end of the track (full steady red).

You can toggle on/off this behavior with *SHIFT + REC*.

## Scratch mode

Toggle with the **JOG SCRATCH** button.

Use the jogwheel to scratch and the outer ring to bend (like in *CD mode*).

- **iCut mode:** Hold *SHIFT* down and scratch to scratch in “automagic” scratch mode. When the jog wheel is turned back, the crossfader is closed. When the jog wheel is turned forward, the crossfader opens. (Note that the Algoriddim djay mapping actually closes/opens the crossfader quickly without taking into account the direction of the wheel, contrary to what the Beatpad’s Quick Start guide says.)

## Seek mode

Toggle with the **JOG SEEK** button.

Use the jogwheel to navigate through the track.

## CD mode

Deactivate both the *Scratch mode* and the *Seek mode* to enable this mode.

Use the jogwheel to temporarily bend the pitch of the track (which only affects the tempo with keylock on).

## PITCH BEND

- **Pitch bend:** Use these buttons temporary slow-down/speed up the tempo of the track. Once the buttons are released the track will continue to play at the tempo designated by the pitch fader.
- **Beat Jump:** Hold *SHIFT* down and then use these buttons to jump 1 beat backwards or forward.

## PITCH

Controls the track's pitch. With keylock on, this only changes the tempo. The red LED indicates that the pitch fader of the unit is on zero (center) position.

## Loops Section

- **Loop size:** Turn the encoder to select the number of beats for a loop. Turn it counterclockwise to half the size of the loop and clockwise to double it.
- **Loop move:** Hold *SHIFT* down and then use the encoder to move the triggered loop forward or backwards by 1 beat.
- **Activate/deactivate:** (Acts exactly like the *LOOP* Button)
- **Regular loop mode:** Push (and release) the encoder to trigger a loop of the selected size
- **Roll loop mode:** Press (and hold down) to trigger a momentary rolling loop of the selected size. While the encoder is held down, the track will keep moving forward as if it was not looping, so when the encoder is released, it will jump forward to where the track would have been if the rolling loop was never enabled. In other words, this is a regular loop in slip mode.
- **Toggle loop mode:** Hold *SHIFT* down and then push the encoder to toggle between Regular and Roll Loop mode.

### Vedi anche:

Rolling loops can be set using the *Bounce Loop (Roll) mode*.

## Effects Section

### FX ON

Push (and release) this button to trigger the selected effect chain for the corresponding deck (toggle function).

### FX SELECT

- **Select:** Use this encoder to select an effect for the current selected rack.
- **Temporary effect:** Push and hold the encoder to temporarily apply the effect of the current selected rack for the corresponding deck (while pressed).
- **Quick Effect:** Hold *SHIFT* down and then push the encoder Activate or Kill the **Quick Effect**. You can change the Quick effect assigned in Mixxx, via Options -> Settings-> Equalizers -> Quick Effect.

## FX PARAM

- **SUPER:** Use this knob to control the **SUPER** parameter of the effect for the current selected rack.
- **MIX:** Hold *SHIFT* down and then use this knob to control the **MIX** parameter of the effect for the current selected rack.

## FILTER

- **Quick Effect:** Use this knob to apply the Quick effect (by default, this is Filter, but you can change it) to the deck. In middle position no effect is applied for filter.
- **Key:** Hold *SHIFT* down and use this knob to adjust the key (pitch) of the track without changing the tempo. In middle position the track will have its original key.

## Pads Section

The 4 Performance Pads offer 4 different modes, depending on the 4 PAD MODE buttons just above.

### HotCues mode

#### CUE

Press the **CUE** mode button to set the PADS to HOT CUE mode.

#### Pads

- **Press** each one of the 4 pads to assign a Hot Cue Point (1 to 4) or returns the track to that Hot Cue Point. When a Hot Cue Button is unlit, you can assign a Hot Cue Point by pressing it at the desired point in your track. Once it is assigned, the Hot Cue Button will light up blue.
- **\*\* *SHIFT* + Press\*\*** to delete its assigned Hot Cue Point.

### Bounce Loop (Roll) mode

#### BOUNCE LOOP

Press the **BOUNCE LOOP** mode button to set the PADS to Loop Roll mode.

#### Pads

Press (and keep down) any of the 4 pads to trigger a momentary *Loop Roll* of a different size (in beats) as per the table.

|                      |      |      |      |      |        |      |       |       |           |       |       |       |
|----------------------|------|------|------|------|--------|------|-------|-------|-----------|-------|-------|-------|
| =====+++++=====      | ==== | ==== | ==== | ==== | Pads 1 | 2    | 3     | 4     | Press 1/8 | 1/4   | 1/2   | 1     |
| <i>SHIFT</i> + Press | 2    | 4    | 8    | 16   | =====  | ++++ | ===== | ===== | =====     | ===== | ===== | ===== |

Once the PAD is released the track will continue to play from the position it would have been if the Loop Roll was never triggered. The size of the applied Loop Roll can be adjusted with the *LOOP SIZE* encoder as well. Pads change the “selected loop size” introduced in *LOOP SIZE* and *LOOP* sections.

## Instant FX mode

### Instant FX

- **Press** this button to set the PADs to Effects mode.
- **Spinback:** Hold *SHIFT* down and then press this button down in order to stop the track with a backward brake effect. If the Instant FX button is released before the track has completely stopped, the track is then played back to its regular speed, in the forward direction.
- **Brake :** see *JUMP* button usage

### Pads

- **Instant FX:** Press (and keep down) any of the 4 pads to apply momentarily the effect of the corresponding effect rack. The parameters of these effects can be adjusted from the *FX PARAM* knob.
- **Current effect rack selection:** Hold *SHIFT* *<reloop-beatpad-shift>* down and then press any of the 4 pads to select the current effect rack for this deck that will be used for effect selection or for the corresponding effect to be triggered later on (see *Effects Section*). this can also be done with a visual feedback in *Sampler mode*.

## Sampler mode

**Note:** On account of the Reeloc Beatpad limitations (bug ?), lights will not show on in Sampler mode when the controller is in *SHIFT* mode.

Press the SAMPLER mode button to set the PADs to cycle between 4 sub modes:

- **Sampler mode** (orange LEDs): each pad triggers a sample from the selected Sampler bank. The PADs which are lit indicate which samples are loaded and ready to use. While a sample is playing, the corresponding PAD changes its color to pink.
- **Sampler bank selection mode** (pink LED): each pad selects 1 of the 4 sampler banks. The PAD that is lit indicates which bank is active.
- **Loop mode** status and selection (magenta LEDs): press any pad to toggle between *regular loop mode* and *roll loop mode*. **Regular loop mode** is symbolized by the left PAD lit, representing the loop), and all the others switched off. **Roll loop mode** is symbolized by both the left (representing the loop) and the right PADs lit (symbolizing the position after the loop where the track will continue to play when the loop will be triggered off).
- **Effect rack selection** mode (purple LED): each pads selects 1 of the 4 effect racks. The PAD which is lit indicates which effect rack is active (see *Effect Section*).

## Troubleshooting

### Grounding problem

If your controller randomly freezes or your iPad or Android tablet acts weirdly (screen flashing, bad sound), make a home made, grounded power cable.

## Controller not detected by Windows

If you see a yellow exclamation point (!) in the Windows Device Manager indicating that the drivers did not start, unplug the power cable from your laptop then unplug/replug the USB cable from your controller. If that does not work, restart your laptop without the power cable plugged in.

### 17.1.102 Reloop Digital Jockey 2 Controller Edition

- [Manufacturer's product page](#)
- [Forum thread](#)

Nuovo nella versione 1.8.

---

**Nota:** Unfortunately a detailed description of this controller mapping is still missing. If you own this controller, please consider [contributing one](#).

---

### 17.1.103 Reloop Digital Jockey 2 Master Edition

- [Manufacturer's product page](#)
- [Forum thread](#)

Nuovo nella versione 1.8.

**Avvertimento:** This device is not USB *MIDI* class compliant. Its signals are translated to *MIDI* by special drivers on Windows and macOS. There is no driver available for Linux.

---

**Nota:** Unfortunately a detailed description of this controller mapping is still missing. If you own this controller, please consider [contributing one](#).

---

### 17.1.104 Reloop Jockey 3 Master Edition

The Reloop Jockey 3 Master Edition is a 2 Channel Controller with the option to control 4 Channels. It has a built-in sound card with 6 channels in and 4 channels out. It features both balanced 1/4» and unbalanced RCA master outputs plus RCA booth outputs with an independent volume control. It can also be used as a stand-alone mixer, or used to mix an analog source with music files in Mixxx. This device requires a power adapter in addition to the USB cable.

- [Mixxx Forum Thread](#)
- [Manufacturer's product page](#)
- [Manufacturer's manual](#)

Nuovo nella versione 2.1.

**Avvertimento:** This device is not USB *MIDI* class compliant. Its signals are translated to *MIDI* by special drivers on Windows and macOS. There is no driver available for Linux.

## Setup

The Mixxx mapping uses the same settings as Reloop's Traktor mapping. Leave the MIDI channels as the default 1-4. If you have problems with the jogwheels, set the jogwheel resolution to 2048. (Please read the manual of this Controller section 5.1 and 5.1.2)

Set the Input 1 and Input 2 switches on the front side of the Jockey 3 ME to SW.

## Mixxx Sound Hardware Preferences

- Master output: channels 1-2
- Headphone output: channels 3-4
- Auxiliary or vinyl input 1: channels 1-2
- Auxiliary or vinyl input 2: channels 3-4
- Microphone input: channels 5-6

## Mapping Description

### Mixer Section

- **Trax encoder:** scroll through library. With shift, scroll through sections on the left side of the library. Push to toggle big library.
- **Load button:** load selected track into active deck
- **Deck switches:** select between controlling deck 1/3 or analog input 1 on the left; select between controlling deck 2/4 or analog input 2 on the right. Note that the analog inputs are only affected by the mixer controls but not the other deck controls.
- **Gain:** set *deck gain*
- **High/mid/low:** adjust EQ for high/mid/low frequencies
- **Master/booth/phones:** control the Jockey 3 ME's sound card. These knobs do not send MIDI messages or adjust values in Mixxx, so turning them will not change anything on screen. Use these but *don't change the software knobs on screen in Mixxx*.
- **Headphones:** play deck on headphone output
- **Cuemix:** Fade between PFL and master output on headphones
- **Vertical faders:** deck volume
- **Level meter LEDs:** show the level of the deck
- **Crossfader:** fade between decks
- **Crossfader curve** (front side of controller): Adjust crossfader curve between fade and cut.

## Transport Section

- **Play/pause:** play/pause or, with shift, toggle keylock
- **Cue:** behavior depends on *cue mode set in Mixxx preferences*. With shift, it does not work as labeled; it toggles quantize.
- **Cup:** Like Cue, but it plays only after releasing the button.
- **Sync:** toggle master sync. With shift, it does not work as labeled; it toggles microphone talkover.

## Jogwheels

Set the jog wheel mode by pressing one of the 4 buttons beside the jog wheel, below the trash and 5-8 buttons.

- **Off:** By default, all mode buttons are off. In this default mode, moving the jogwheel temporarily bends the pitch, regardless of whether it is moved from the top or the side.
- **Scratch:** Move the wheel from the top to scratch. Touch the outside rubber ring to temporarily bend the pitch.
- **Pitch bend:** Move the wheel to control the SuperKnob on EffectUnit of this Deck. FIXME (Maybe a Touch Control?)
- **Search:** Search position in file quickly. Touch stops the Deck.
- **Trax:** Not Mapped. FIXME (No Plans)

## Hotcue Section

Press an unlit hotcue button to set that hotcue at the current position. Press a lit hotcue button to jump to that hotcue. To delete a hotcue, hold the Trash button while pressing a hotcue. To toggle between hotcues 1-4 and 5-8, press the 5-8 button.

## Loop Section

- **Length encoder:** Press to activate a 4 beat loop. Double or half the beats of the loop by turning
- **Move encoder:** Move a track 4 Beats forward or backward. Push, hold and Turn it to halve or double the value of 4 Beats.
- **Loop button:** Turn on/off a Loop that is set from Length encoder. With shift, sets the start position of a loop.
- **Reloop button:** Repeat the entire file. With shift, sets the end position of a loop.

## Other controls

- **Filter:** turn to apply a highpass or lowpass filter. On Deck A, press Shift and turn Filter to adjust the Gain of the Microphone
- **Pan:** On Deck A, turn to fade between the left and right speakers on the master output. (Balance)
- **< Beat:** Beatjump by one beat back. With shift, moves the beatgrid lines further from each other (lower BPM by 0.01)
- **Beat >:** Beatjump by one beat forward. With shift, moves beatgrid lines closer to each other (raise BPM by 0.01)
- **Pitch fader:** adjust playback rate of deck (with keylock, only adjusts tempo and not pitch)



- +/-: Pitch temporarily faster or slower.
- **FX 1:** Shift - (Minus) does not function as labeled. It aligns the beatgrid with the current play position.

## Effect Section

The effect section controls the effect chain with the same number as the deck selected by the deck switch, although any effect chain can be applied to any deck.

- **Dry/wet:** adjust how much the effect is applied. With shift, turn to select different effect chain presets
- **FX Param:** adjust effect parameters 1-3 for the first effect in the chain.
- **Press FX Param 1-3 + Shift:** edit how effect parameters are linked to the superknob. The effect selected corresponds to the number of the FX Param encoder pressed. For example, pressing FX Param 2 with shift on deck 3 edits Effect2 of the EffectRack3. Each encoder press with shift changes what is being edited:
  - Select which effect parameter to edit
  - Select a [[effects framework#linking values|superknob link type between 0 and 4]] for the parameter selected on the first press
  - Select whether the [[effects framework#linking values|superknob link is inverted]] for the parameter selected on the first press
  - Close superknob link editing mode
- **FX on:** enable/disable effect chain
- **FX B1/2/3:** enable/disable effect 1/2/3 on this chain
- **Preset 1-4** (shift+effect buttons): apply effect chain to that deck number

### 17.1.105 Reloop Terminal Mix 2/4

- [Terminal Mix 2 product page](#)
- [Terminal Mix 4 product page](#)

The Reloop Terminal Mix 2 and Terminal Mix 4 use the same mapping in Mixxx.

Nuovo nella versione 1.11.

## Sound hardware

The Reloop Terminal Mix 2 and Terminal Mix 4 have integrated multichannel sound cards. Usually, the TerminalMix runs very well with USB power only. If you experience issues especially when powering both Master and Booth outputs at high levels you should use the additional power supply (6v/1.5A). The official manual from Reloop states not to operate the unit at temperatures below 5°C/41°F as it might damage A/D converters and other components. However, the audio output may already start crackling if the temperature drops below 10°C.

## Inputs

Both TerminalMix 2 and 4 have a microphone and a switchable line/phono input that can be routed into Mixxx. The Microphone jack is at the front side of the controller, the RCA line jacks are at the back next to the line/phono switch. For both inputs there is a gain knob and a switch on the controller's front side that toggles between routing the signal to the computer (SW) or mixing it directly with the master output (MST). MST allows to play music from external sources without any software, for example while setting up Mixxx software. Switch to SW if you want to use the line signal for vinyl control or AUX input, or if you want to record the microphone input with Mixxx, broadcast it, or put on effects.

## Outputs

At the front, there are two headphone jacks (1/8" and 1/4"), both affected by the hard-wired TONE knob. At the back, there are unbalanced outputs for booth and master (RCA), as well as a balanced master output (1/4"). The output level of both master outputs, booth and headphone outputs are all controlled by respective hard-wired knobs in the center column which can't be mapped to software.

## Controller hardware / Maintenance

The jog wheels' touch sensitivity can be adjusted separately. Refer to the [official manual](#) for instructions.

When used in dusty environment for a while you might find the MIDI LED flickering although you didn't touch any of the controls. This is mostly due to dust/fuzz particles in the 'comb' at the jog wheels' underside that is distracting the IR light barriers that detect platter movement. Remove the particles with a vacuum cleaner, or blow into the gap between wheel and housing.

After a few years of heavy usage the buttons and sliders may start to wear out. Then, buttons need to be pressed harder or in a different manner than what was working before, and sliders may send false values when they are actually in the 'off zone'. Luckily, the buttons are standard parts and relatively easy to replace, and the sliders' conductive surface can be cleaned with Q-tips and alcohol.

## Mapping options

The mapping the following customization variable at the top of the script you can set to your liking:

- `pitchRanges`: Set the pitch slider range each time you toggle it.

Just open the `Reloop Terminal Mix 2-4.js` file in your favorite text editor and you'll see these variables right near the top. Edit and save and Mixxx will automatically reload the mapping.

## Deck controls

*The controls are the same on both sides of the controller. The left side controls Deck 1 or 3 and the right side controls Deck 2 or 4.*

- RANGE button - Toggles the pitch slider range. See [Mapping Options](#).
- KEYLOCK\* button - Toggles key lock.

## FX Controls

This mapping uses the [Standard Effects Mapping](#) to control the FX units.

---

**Nota:** These knobs and buttons don't switch to decks 3 and 4.

---

- FX1/2/3 knobs
  - control the Meta knob of each effect
  - focused effect: control the first three knob parameters of the focused effect
- ON buttons
  - Press: toggle the effects
  - Press + hold: temporarily toggle an effect
  - focused effect: control the first three button parameters of the focused effect
- BEATS encoder
  - Turn: adjust the Wet/Dry knob of the effect unit
  - Press repeatedly: adjust the BPM (not the pitch/speed!) of the loaded track
  - SHIFT + Press: move the nearest beat marker to the current play position
- TAP button
  - LED flashes on each beat
  - Press + hold, then press any ON button to focus the respective effect
  - SHIFT + Press: switch between FX units 1/3 (left FX section) and 2/4 (right FX section)

## Loop Controls

- LENGTH knob
  - Turn: double or halve the current *loop size* (beats) visible in loop size spinbox in each skin.
  - Press: set and activate a loop of *loop size*
- SHIFT + Press: re-activate the previous loop
  - play position behind loop-out: jump to loop-in point and play loop from there
  - play position before loop: activate loop, keep playing and enter loop when play position crosses loop-in marker
- IN / 1/2x button
  - Press: set the loop in point, flashes when a loop is active
  - Press + hold: drags the loop in point of an active loop
- OUT / 2x button
  - Press: set the loop out point, flashes when a loop is active
  - Press + hold: drags the loop out point of an active loop
- MOVE knob
  - Press + turn: adjust the *//beatjump size//* visible in beatjump spinbox in each skin

- Turn with no active loop: jump back or forth in the track by beatjump size
- Turn with active loop + Quantize OFF: move the loop position by 1/8 beat per detent (helpful to correct the loop in point in case it's set slightly too early or too late)
- Turn with active loop + Quantize ON: move the loop position by one beat per detent (helpful to correct the loop in point in case it snapped to the wrong beat marker)
- SHIFT + turn with active loop: shift the loop back or forth by beatjump size

## Hot cues / Sampler buttons

- Hot cue buttons 1-4
  - LED: lit if a hot cue is set
  - Press: set or recall a hot cue
  - Press + hold when deck is stopped: play from hot cue as long as button is pressed. Press Play to continue playing after releasing hot cue button
  - Press + hold when deck is playing: jump to hot cue and play from there
  - SHIFT + press: delete the hot cue
- ► 1-4 Sampler buttons
- LED: lit when a sample is loaded to the corresponding sampler, flashes when that sampler is playing.
- Press: play the sample from the beginning
- SHIFT + Press: stop the sample
- ✂ (scissors) button - Switches hot cues 5-8 and samplers 5-8

## Wheel & Vinyl button

- Vinyl/Search button
- Press + release: toggle scratching with the wheel (LED On)
- Hold down + turn the wheel: seek through the track
- Wheel
- Vinyl mode ON
  - Touch the top black area + turn: scratch the current track like a vinyl record
  - Touch gray rim only + turn: perform a temporary pitch bend
- Vinyl mode OFF
  - Touch wheel anywhere + turn: perform a temporary pitch bend

## Transport buttons

- **▶◀** (Sync) - Synchronizes the tempo and beat phase of this deck to that of the other.
- **CUP** (Cue-Play) Start playback from the cue point (also known as stutter play)
- **Q** (Cue)
  - LED: lit or flashes when play position is at cue point, depending on the *cue mode*.
  - Press: Set or recall the main cue point on the track
  - Press + hold: play from Cue point. Release stops playback
- **▶||** (Play/Pause) Toggle playback of the track
- **SHIFT + ▶◀** (left deck) / **SHIFT + ▶||** (right deck)
  - initiate the brake effect for the respective deck: track slows down to full stop.
- Touch wheel, Vinyl mode ON: track speed jumps back to normal (considering the pitch slider) and playback continues as soon as the wheel is released. Open the `controllers/ReLoop Terminal Mix 2-4.js` file and look for `TerminalMix.brake` to adjust parameters.
- **3 / 4** button - When lit all deck buttons (except FX controls) control deck 3 (deck 4 respectively).

## Mixer controls

### Channel strips

*The below controls adjust the specified parameter of the respective virtual deck.*

- **GAIN** knob - Adjusts the pre-fader gain
- **HIGH/MID/LOW** EQ knobs - Adjust the volume of the respective frequency range
- **FILTER** knob - Adjust the QuickEffect Meta knob (default: filter)
- **Headphone** button - Toggles hearing the deck in the headphone output
- **1 / 2 / 3 / 4**
  - Press: load the currently highlighted song into that deck.
  - **SHIFT + press**: toggle fader-start (on the channel fader and cross-fader when applicable.) The button flashes when fader-start is enabled on that deck.
- **Channel slider** - Adjust the output volume

*The below controls are not deck-specific.*

- **MASTER** knob - Adjust the master output volume of the internal sound card. (*Hard-wired knob, does not send MIDI messages*)
- **BOOTH** knob - Adjust the booth output volume of the internal sound card. (*Hard-wired knob, does not send MIDI messages*)
- **PHONES** knob - Adjust the headphone output volume of the internal sound card. (*Hard-wired knob, does not send MIDI messages*)
- **CUE MIX** knob - Adjust how much of the headphone bus vs the master output you hear in the headphones.
- **SAMPLER VOLUME** knob - Adjusts the volume of all of the samplers at once.

- CRATES button - Does nothing at the moment. (Mixxx's library doesn't yet support direct panel selection.) Use the MIDI Learning Wizard to assign an action.\*
- VIEW button - Does nothing at the moment. Use the MIDI Learning Wizard to assign an action.\* - PREP button - *Does nothing at the moment. Use the MIDI Learning Wizard to assign an action.*
- BACK button
  - Press: move the highlight in the active library panel to the right
  - SHIFT + Press: move the highlight to the left
- TRAX knob
  - Turn: move the highlight up/down by one line
  - SHIFT + turn: move the highlight one page up/down
  - Press while Tree panel has focus: expand an item if possible. If item can't be expanded further, it is selected and highlight is shifted rightward to the respective tracks table.
  - Press while tracks table has focus: perform the Track Load Action specified in *Preferences* ▶ *Library* (default: load track to next empty deck)
- Volume Level Meter
  - LEDs display the hardware (!) volume of the Master output (2 blue LEDs at the top indicate clipping)
  - *Attention:* the Master volume might already clip in Mixxx before the hardware LEDs light up. You can adjust the hardware Master volume knob and target loudness in *Preferences* ▶ *Normalization* ▶ *ReplayGain* to keep enough headroom for the Master volume in Mixxx and make the lower blue LEDs light up when the Master volume clips in Mixxx
- POWER LED (red)
- MIDI LED (blue)
  - Flashes when a MIDI messages was sent
  - When it flashes although no control is touched, it's probably due to dust in the jogwheels (See *Controler Hardware / Maintenance*)
- Shift Lock switch at the back side
  - ON: press SHIFT buttons once to switch to secondary button/knob actions
  - OFF: press & hold SHIFT buttons to switch to secondary button/knob actions

### Cross-fader section

Move the cross-fader to smoothly fade between the decks assigned to either side.

### Deck assign switches (Terminal Mix 4 only)

Use the four switches on the front of the unit to choose on which side of the cross fader that deck will be heard. (Note that the fader-start functionality correctly follows this assignment.) If “thru” is selected, the cross-fader will not affect the audio from that deck and it will always be heard.

### Curve adjust

Use the knob to adjust the curve from a smooth fade to a fast cut.

*The remaining controls on the front of the unit adjust hardware parameters and are not MIDI-mappable.*

## 17.1.106 Roland DJ-505

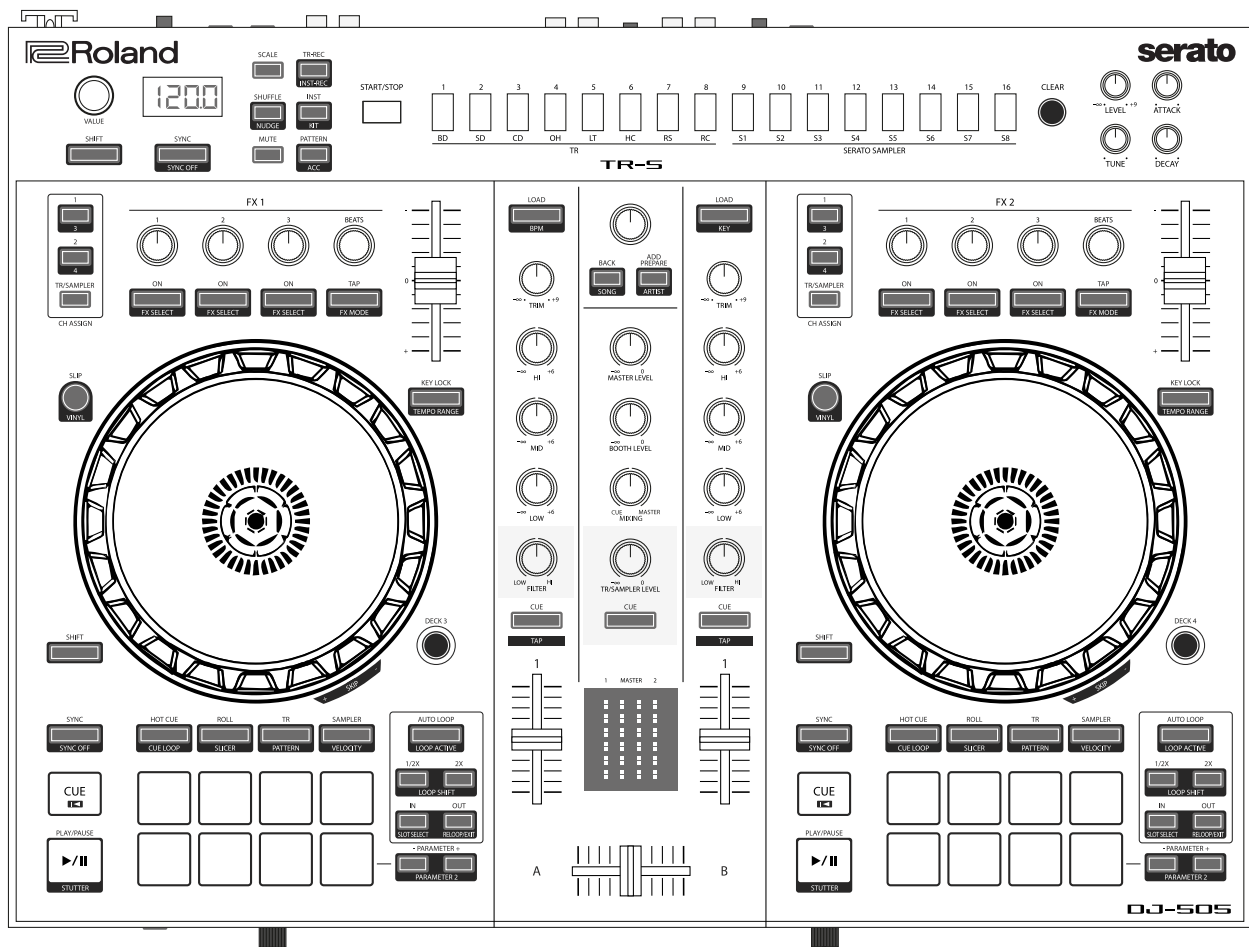

Figure61: Roland DJ-505 (schematic view)

The Roland DJ-505 is an all-in-one USB *MIDI* controller with an integrated audio interface. It has controls for 2 decks that can be toggled between decks to play with 4 decks. It also features a TR-S step sequencer with sounds from the TR-808 and the TR-909 drum machines (TR-606 and TR-707 are available via firmware update).

- [Manufacturer's product page](#)

- [Serato DJ Hardware Page](#)
- [Owner's Manual](#)
- [Driver/Firmware/TR-S Samples Download Page](#)
- [Mapping Forum Thread](#)

Nuovo nella versione 2.3.0.

## Drivers

You can download the latest Windows & MacOS drivers and firmware from the [manufacturer's website](#). Since the DJ-505 is a USB class compliant MIDI and audio device, the device is plug-and-play on Linux.

## Audio Setup

The mapping relies on the following channel assignments (for line/phono input support, applying effects to the TR-S output, etc.):

| Output Channels | Assigned to |
|-----------------|-------------|
| 1-2             | Master      |
| 3-4             | Headphones  |

| Input Channels        | Assigned to      |
|-----------------------|------------------|
| 1-2 (CH 1 Line/Phono) | Vinyl Control 1  |
| 3-4 (CH 2 Line/Phono) | Vinyl Control 2  |
| 5-6 (Mix)             | Record/Broadcast |
| 7-8 (TR-S output)     | Auxiliary 1      |

The microphone, TR-S drum machine, and external inputs are mixed together in input channels 5-6, so Mixxx can record and broadcast them.

The knobs for MASTER LEVEL, BOOTH LEVEL, PHONES VOLUME, MIC LEVEL, TR/SAMPLER LEVEL and CUE/MASTER MIXING are controlling the hardware mixer of the built-in audio interface. Hence, turning the knobs will not change values in the Mixxx *GUI* and you'll need to set the Mixxx knobs to their default values when using the controller:

- Set the master/booth/headphones/microphone/aux channel levels to 100% (knob center position)
- Set cue/master mixing to cue-only (leftmost position)

---

**Nota:** You should assign the *Vinyl Control* input channels even if you do not intend to use timecode vinyl. These channel assignments are also needed to make the CH 1/2 PC/LINE/PHONO switches work (i. e. passing through line or phono input to the left/right deck).

---



## Controller Mapping

The control numbering in the schematic drawings matches the those found on the specified page in the Owner’s Manual.

### Browser Section (p. 4)

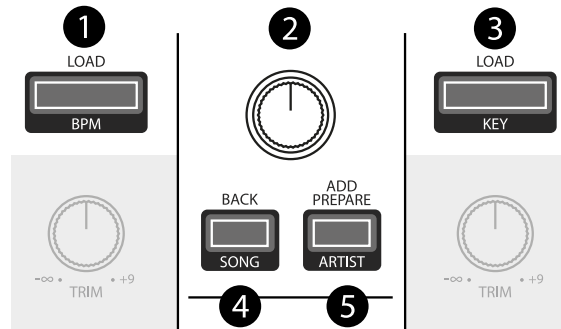

Figure62: Roland DJ-505 (browser section)

| No. | Control                     | Function  |
|-----|-----------------------------|---|
| 1   | LOAD buttons                | Load song into deck.  |
| 1   | SHIFT + LOAD button (left)  | Sort library by BPM (press repeatedly to toggle ascending/descending order).  |
| 1   | SHIFT + LOAD button (right) | Sort library by key (press repeatedly to toggle ascending/descending order).  |
| 2   | Rotary Selector             | Turn to move tracklist cursor up/down. Press to load and play/pause currently selected track on preview deck. Hold and turn to seek in track on preview deck. |
| 2   | SHIFT + Rotary Selector     | Turn to move sidebar cursor up/down. Hold and turn to change track color of currently selected track.   |
| 3   | BACK button                 | <i>Not yet mapped.</i>  |
| 3   | SHIFT + BACK button         | Sort library by title (press repeatedly to toggle ascending/descending order).  |
| 4   | ADD PREPARE button          | (Un-)Maximizes the library view.  |
| 4   | SHIFT + ADD PREPARE button  | Sort library by artist (press repeatedly to toggle ascending/descending order).   |

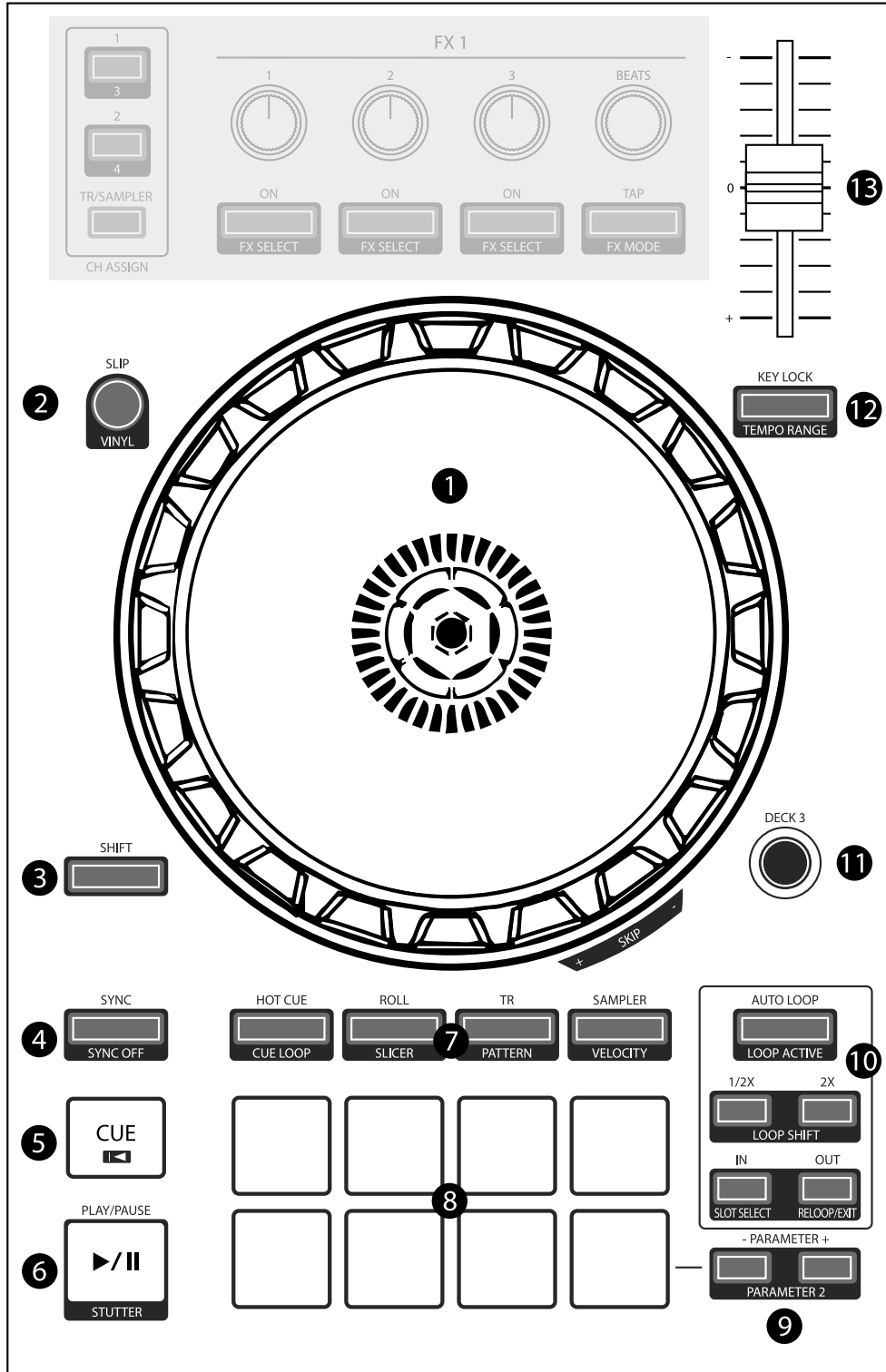

Figure63: Roland DJ-505 (deck section)

Deck Section (p. 5-6)

| No. | Control                             | Function   |
|-----|-------------------------------------|--|
| 1   | Jog Wheel (top surface)             | Perform scratch operation.   |
| 1   | Jog Wheel (outer edge)              | Rotate to lower/raise playback speed and pitch if key lock is off).                              |
| 1   | SHIFT + Jog Wheel (top surface)     | Search fast through the track location.  |
| 2   | SLIP button                         | Hold to turn on slip mode temporarily or double press to turn it on permanently.                 |
| 2   | SHIFT + SLIP button                 | Toggle vinyl control mode.   |
| 3   | SHIFT button                        | Hold down to access other functions.   |
| 4   | SYNC button                         | Short press to match tempo and phase of other deck once. Long press to enable <i>Sync Lock</i> . |
| 4   | SHIFT + SYNC button                 | Short press to disable <i>Sync Lock</i> . Long press to toggle <i>quantization</i> .             |
| 5   | CUE button                          | Specifies, plays or recalls temporary cue point.   |
| 5   | SHIFT + CUE button                  | Returns to the beginning of the song.  |
| 6   | PLAY/PAUSE button                   | Plays or pause the song.   |
| 6   | SHIFT + PLAY/PAUSE button           | Hold to play backwards.  |
| 7   | Pad Mode Select                     | See <i>Performance Pads</i> .  |
| 8   | Performance Pads                    | See <i>Performance Pads</i> .  |
| 9   | PARAMETER area                      | See <i>Performance Pads</i> .  |
| 10  | LOOP area: AUTO LOOP button         | Set a beatloop at the current play position.   |
| 10  | LOOP area: SHIFT + AUTO LOOP button | Toggle looping.  |
| 10  | LOOP area: 1/2X/2X buttons          | Set the loop playback length to half/double.   |
| 10  | LOOP area: SHIFT + 1/2X button      | Move the loop by it's length toward the left.  |
| 10  | LOOP area: SHIFT + 2X button        | Move the loop by it's length toward theright.  |
| 10  | LOOP area: IN/OUT button            | Specify loop-in/loop-out points.   |
| 10  | LOOP area: SHIFT + IN button        | Toggle beats quantization.   |
| 10  | LOOP area: SHIFT + OUT button       | Toggle looping, go to loop-in point and resume playback.   |
| 11  | DECK 3/DECK 4 buttons               | Switches the deck (left: decks 1 and 3, right: decks 2 and 4)                                    |
| 12  | KEY LOCK                            | Toggle key lock.   |
| 12  | SHIFT + KEY LOCK                    | Cycles through tempo slider range (8%, 16%, 50%).  |
| 13  | Tempo slider                        | Adjust song playback speed (and pitch if key lock if off).                                       |

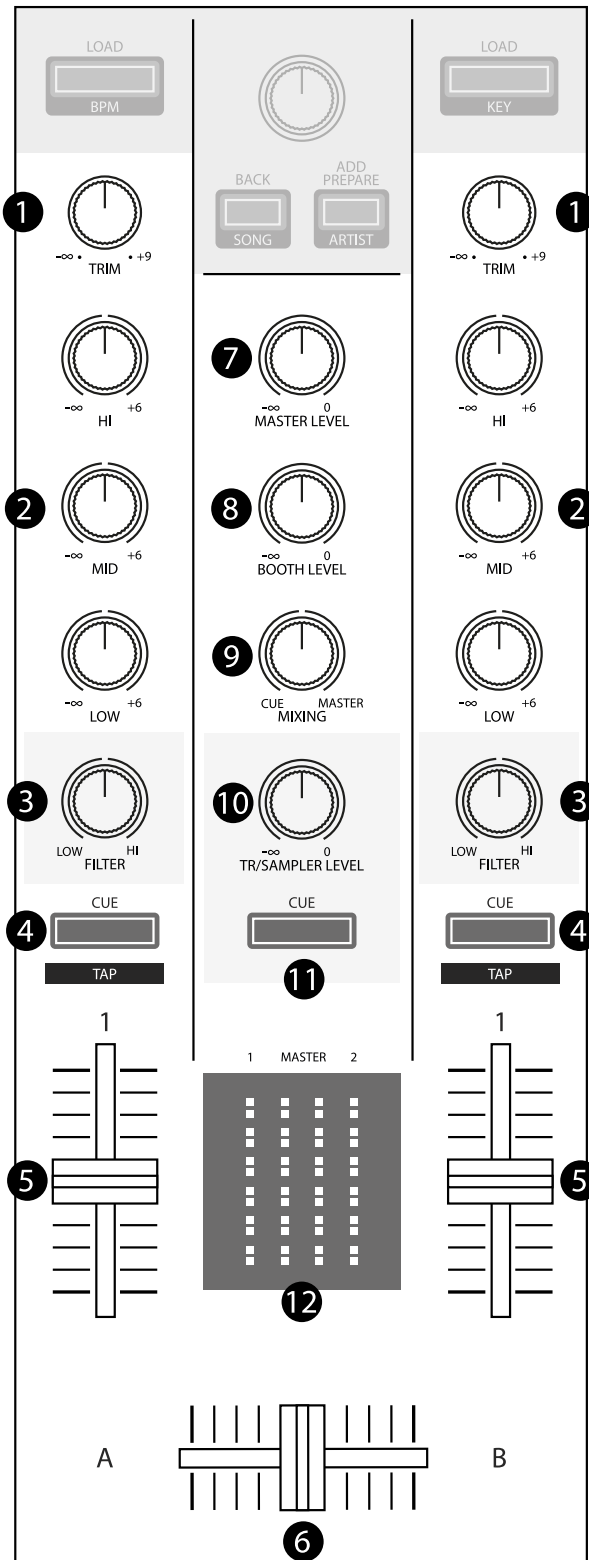

Figure64: Roland DJ-505 (mixer section)

Mixer Section (p. 7)

| No. | Control                              | Function   |
|-----|--------------------------------------|--|
| 1   | TRIM knobs                           | Adjust the deck gain (prefader)  |
| 2   | HI/MID/LOW knobs                     | Adjust the high/mid/low-frequency regions of the song.   |
| 3   | FILTER knobs                         | QuickEffect superknob (filter by default, can be changed to a different effect in Mixxx preferences) |
| 4   | Channel CUE buttons                  | Toggle PFL for each channel.   |
| 4   | SHIFT + CUE buttons (short press)    | Adjust beatgrid so that the closest beat is set to the current cursor position.                      |
| 4   | SHIFT + CUE buttons (long press)     | Adjust beatgrid to match another playing deck.   |
| 4   | SHIFT + CUE buttons (tap repeatedly) | Set tempo by tapping on each beat.   |
| 5   | Channel faders                       | Adjust the output level for each channel.  |
| 6   | Cross fader                          | Fades between left and right deck.   |
| 7   | MASTER LEVEL knob                    | Adjusts the master output level.   |
| 8   | BOOTH LEVEL knob                     | Adjusts the output level of the BOOTH OUT jacks.   |
| 9   | MIXING knob                          | Fades between PFL and master output in headphones  |
| 10  | TR/SAMPLER LEVEL knob                | Adjusts output of the TR-S (Aux 3) and Samplers 1-16.  |
| 11  | TR/SAMPLER CUE button                | Toggle PFL of the TR-S (Aux 3) and Samplers 1-16.  |
| 12  | Level indicator                      | Indicate the output level of each channel and master.  |

Effects Section (p. 7)

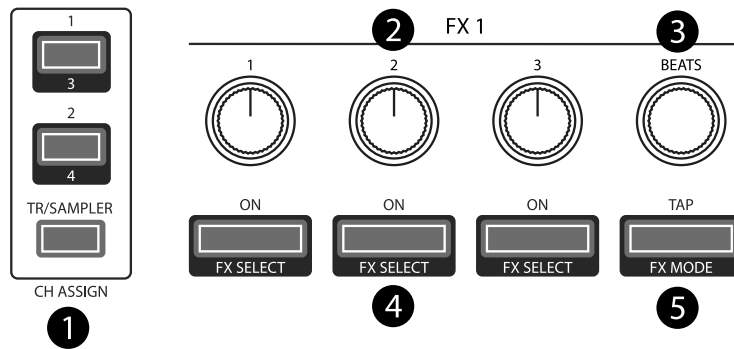

Figure65: Roland DJ-505 (effects section)

| No. | Control        | Function   |
|-----|----------------|--|
| 1   | CH ASSIGN area | Toggle effect units 1/2 for decks 1/2 (3/4 if SHIFT is pressed) or the TR-S (Aux 3) and Samplers 1-16. |
| 2-5 | Various        | See <a href="#">Standard Effects Mapping</a> .   |

TR-S Section (p. 8)

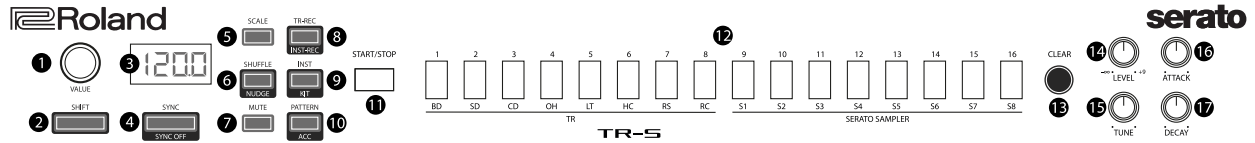

Figure66: Roland DJ-505 (TR-S section)

| No.  | Control             | Function  |
|------|---------------------|---|
| 1    | VALUE knob          | <i>See Owner's Manual.</i>  |
| 2    | SHIFT button        | Hold down to access other functions.  |
| 3    | Display             | <i>See Owner's Manual.</i>  |
| 4    | SYNC button         | Match tempo of playing deck (phase matching is not implemented yet, use the NUDDGE button instead). |
| 4    | SHIFT + SYNC button | <i>Currently not mapped.</i>  |
| 5-17 | <i>Various</i>      | <i>See Owner's Manual.</i>  |

Front Panel (p. 8)

| No. | Control                       | Function   |
|-----|-------------------------------|--|
| 1   | PHONES jacks                  | Connect headphones here.   |
| 2   | VOLUME knob                   | Adjust the volume of the headphones.   |
| 3   | CROSS FADER switch            | Switch the cross fader response curve.                                       |
| 4   | REVERSE switch                | Switch cross fader reverse (hamster) mode on/off.                            |
| 5   | CH1/CH 2 switches: PC         | Selects Mixxx deck as input source (Unmute the Mixxx deck and mute Aux 1/2). |
| 5   | CH1/CH 2 switches: LINE/PHONO | Selects Line/Phono input source (Mute the Mixxx deck and unmute Aux 1/2).    |
| 6   | MIC LEVEL knob                | Adjust the microphone volume.  |

Performance Pads

You can use the Pad Mode Select buttons to select a mode for the performance pads.

| Control                              | Mode                  | LED Color  |
|--------------------------------------|-----------------------|------------|
| HOT CUE button                       | Hot Cue Mode          | White      |
| SHIFT + HOT CUE button               | Cue Loop Mode         | Blue       |
| SHIFT + HOT CUE button (press twice) | Prepare Mode          | Red        |
| ROLL button                          | Roll Mode             | Light blue |
| ROLL button (press twice)            | Loop Mode             | Green      |
| TR button                            | TR Mode               | Red        |
| SHIFT + TR button                    | Pattern Mode          | Green      |
| TR button (press twice)              | TR Velocity Mode      | Orange     |
| SAMPLER button                       | Sampler Mode          | Magenta    |
| SHIFT + SAMPLER button               | Velocity Sampler Mode | Purple     |
| SAMPLER button (press twice)         | Pitch Play Mode       | Green      |

Most pad modes are similar to those found when used with Serato. A notable exception is the Loop Mode, which replaces the Serato's Saved Loop Mode. In this mapping, the Loop Mode is similar to the Roll mode, but sets a non-rolling beatloop instead.

Modes that are described in the owner's manual (Slicer, Slicer Loop, Saved Loop, Flip) but not listed below are currently not mapped.

### Hot Cue Mode

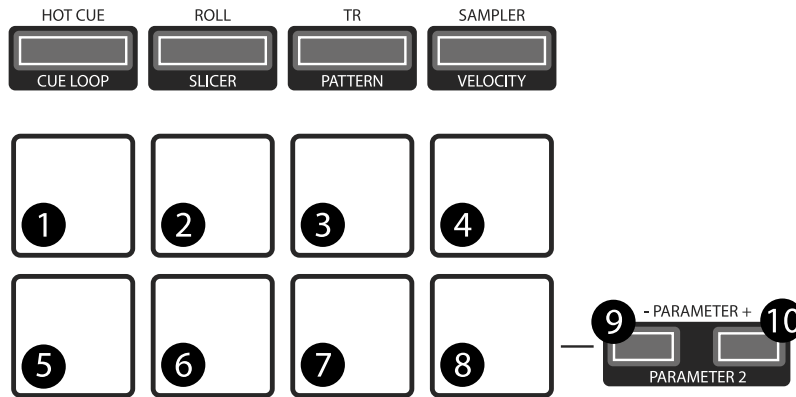

Figure67: Roland DJ-505 (performance pads)

Bookmark positions in the track and jump to them.

| No. | Control                    | Function  |
|-----|----------------------------|---|
| 1-8 | Pad (unlit)                | Save current position as hot cue.   |
| 1-8 | Pad (lit)                  | Jump to hot cue. If the track is stopped, holding the pad will preview the hot cue until the pad is released. |
| 1-8 | SHIFT + Pad (lit)          | Clear hot cue.  |
| 9   | PARAMETER - button         | Change color of last used hotcue to the previous color in the palette.  |
| 10  | PARAMETER + button         | Change color of last used hotcue to the next color in the palette.  |
| 9   | SHIFT + PARAMETER - button | Move beatgrid left.   |
| 10  | SHIFT + PARAMETER + button | Move beatgrid right.  |

### Cue Loop Mode

Set beatloop from a hot cue point.

| No.  | Control                       | Function   |
|------|-------------------------------|--|
| 1-8  | Pad (lit)                     | Set a beatloop at the position of the hotcue and jump to it. |
| 1-8  | Pad (unlit)                   | Save the current position as hot cue and set a beatloop.     |
| 9    | PARAMETER - button            | Halve the size of the current loop.                          |
| 10   | PARAMETER + button            | Double the size of the current loop.                         |
| 9-10 | SHIFT + PARAMETER -/+ buttons | <i>Currently not mapped.</i>                                 |

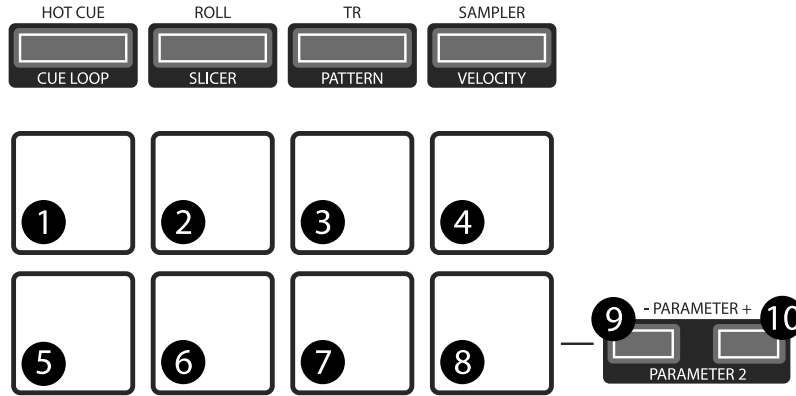

Figure68: Roland DJ-505 (performance pads)

### Prepare Mode

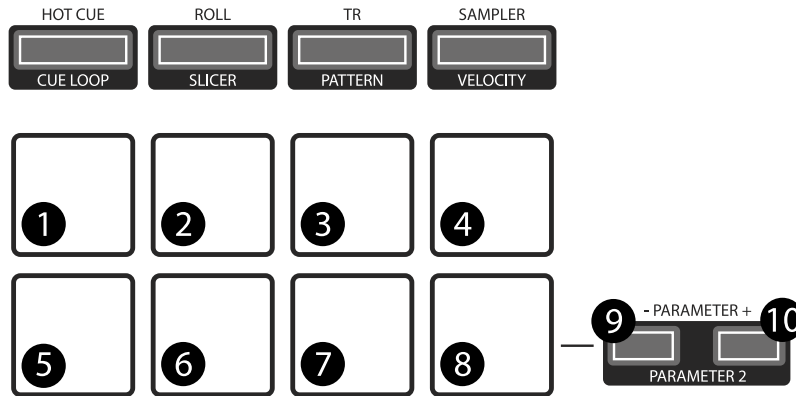

Figure69: Roland DJ-505 (performance pads)

This mode allow you to prepare tracks by setting intro/outro cues.

| No.  | Control                       | Function                             |
|------|-------------------------------|--------------------------------------|
| 1    | Pad (unlit)                   | Set current position as intro start. |
| 1    | Pad (lit)                     | Jump to intro start position.        |
| 2    | Pad (unlit)                   | Set current position as intro end.   |
| 2    | Pad (lit)                     | Jump to intro end position.          |
| 3    | Pad (unlit)                   | Set current position as outro start. |
| 3    | Pad (lit)                     | Jump to outro start position.        |
| 4    | Pad (unlit)                   | Set current position as outro end.   |
| 4    | Pad (lit)                     | Jump to outro end position.          |
| 5-8  | Pad                           | <i>Currently not mapped.</i>         |
| 9-10 | SHIFT + PARAMETER +/- buttons | <i>Currently not mapped.</i>         |

**Nota:** This mode has been added by the Mixxx developers and is not available in Serato.



## Roll Mode

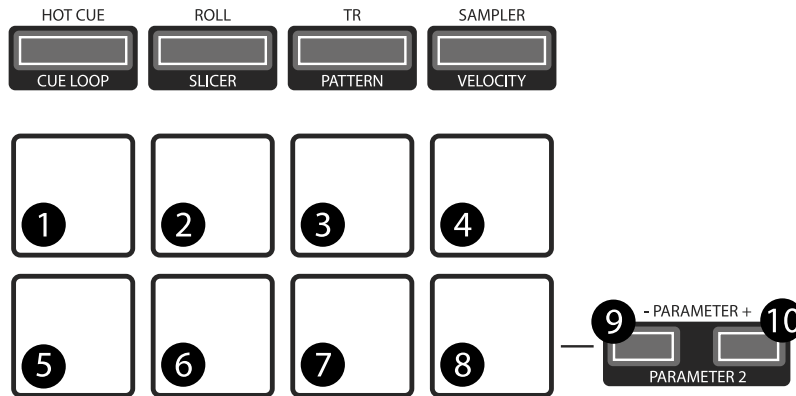

Figure70: Roland DJ-505 (performance pads)

The Roll Mode provides quick access to rolling loops and beatjumps.

| No.  | Control                       | Function   |
|------|-------------------------------|--|
| 1-4  | Pad (hold)                    | Play a rolling loop with the beatlength that is assigned to the pad. |
| 5    | Pad (press)                   | Beatjump left.   |
| 6    | Pad (press)                   | Decrease beatjump size.  |
| 7    | Pad (press)                   | Increase beatjump size.  |
| 8    | Pad (press)                   | Beatjump right.  |
| 9    | PARAMETER - button            | Halve the size of the current loop.                                  |
| 10   | PARAMETER + button            | Double the size of the current loop.                                 |
| 9-10 | SHIFT + PARAMETER +/- buttons | <i>Currently not mapped.</i>   |

## TR/Pattern/TR Velocity Modes

These modes are hardcoded in the device firmware, so they work exactly as described in the Owner's Manual.

## Sampler/Velocity Sampler Play Modes

The sampler modes allow you to load, play and stop samples in the first 8 sample slots.

| No.  | Control               | Function  |
|------|-----------------------|---|
| 1-8  | Pad (unlit)           | Load currently selected track into the sample slot associated with the pad.   |
| 1-8  | SHIFT + Pad (lit)     | If the sample is playing, stop the playback. If the sample is not playing, eject the sample from the sample slot.   |
| 1-8  | Pad (lit)             | Play the sample in the sample slot associated with the pad. <i>Velocity Sampler Mode:</i> The playback volume of the sample depends on the pressure (velocity). |
| 9-10 | PARAMETER +/- buttons | <i>Currently not mapped.</i>  |

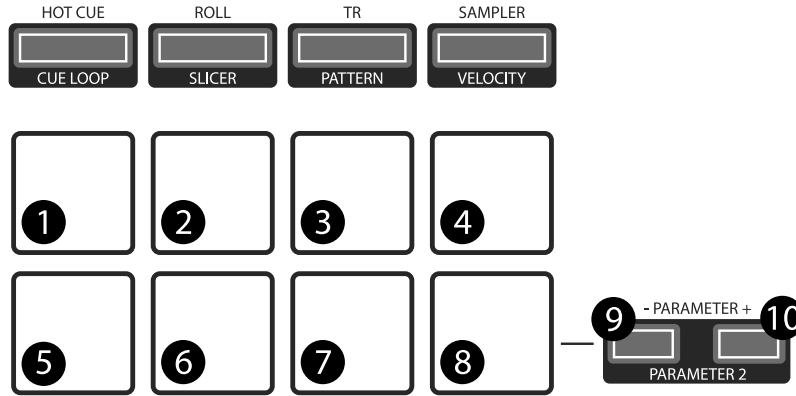

Figure71: Roland DJ-505 (performance pads)

### Pitch Play Mode

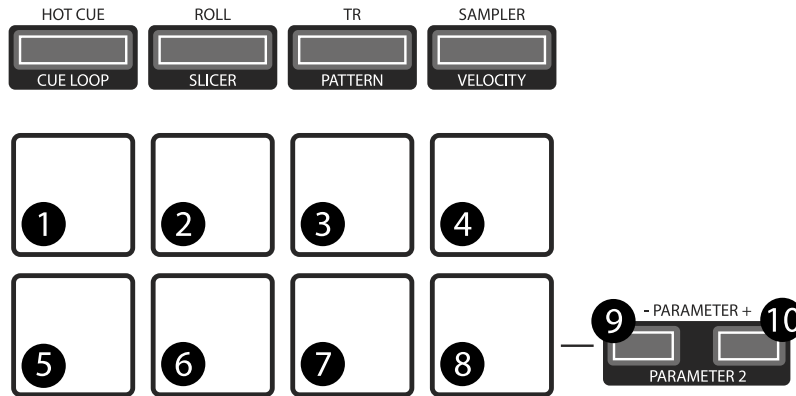

Figure72: Roland DJ-505 (performance pads)

Play the track from a hot cue position and change the pitch in semitone steps. Pads right of the white lit pad raise the pitch, pads left of it lower it.

| No.  | Control                 | Function  |
|------|-------------------------|---|
| 1-8  | Pad                     | Play currently selected hotcue with modified pitch.                                 |
| 1-8  | SHIFT + Pad (dimly lit) | Select hot cue for pitch play. The pad of the currently selected hotcue pad is lit. |
| 9-10 | PARAMETER +/- buttons   | Cycles through semitone ranges (Up, Mid, Down).                                     |

## Known Issues

- TR-S Syncing currently works at the *BPM* level, but phase syncing is not implemented yet. As a workaround, the NUDGE button can be used to adjust the phase. This depends on *MIDI* clock I/O ([Launchpad Bug #682221](#)).
- Some performance pad modes are missing (Slicer [[Launchpad Bug #1828886](#)], Slicer Loop, Saved Loop [[Launchpad Bug #1367159](#), [PR #2194](#) ], Flip [[Launchpad Bug #1768113](#)])
- Some buttons are not mapped yet (e.g. BACK)
- LEDs on BACK/ADD PREPARE do not work (this seems to be a hardware/firmware bug and does not work in Serato either)
- Controller does not send current cross fader value on Serato SysEx Message (this seems to be a hardware/firmware bug and does not work in Serato either)

### 17.1.107 Sony Sixxaxis

The Sony Sixxaxis is a motion-sensitive wireless game console controller.

- [Forum thread](#)

Nuovo nella versione 1.11.

---

**Nota:** Unfortunately a detailed description of this controller mapping is still missing. If you own this controller, please consider [contributing one](#).

---

### 17.1.108 Soundless Studio joyMIDI

The joyMIDI is a portable 4-in-1 MIDI controller with 4 operating modes: Keyboard (MIDI), DrumPad (MIDI), DJ (MIDI) and GamePad (HID joystick). The case is 3D printed and the design files are open source on [Onshape](#).

- [User Manual](#) (See the chapter 7.3 , DJ controller mode)
- [Forum thread](#)

Nuovo nella versione 2.2.4.

## Mapping Description

After powering on the device, press the right button to enter the DJ controller mode.

### Bank 1

### Bank 2

### Bank 3



Figure73: Soundless Studio joyMIDI (top view)



Figure74: Entering the DJ controller mode on the joyMIDI.

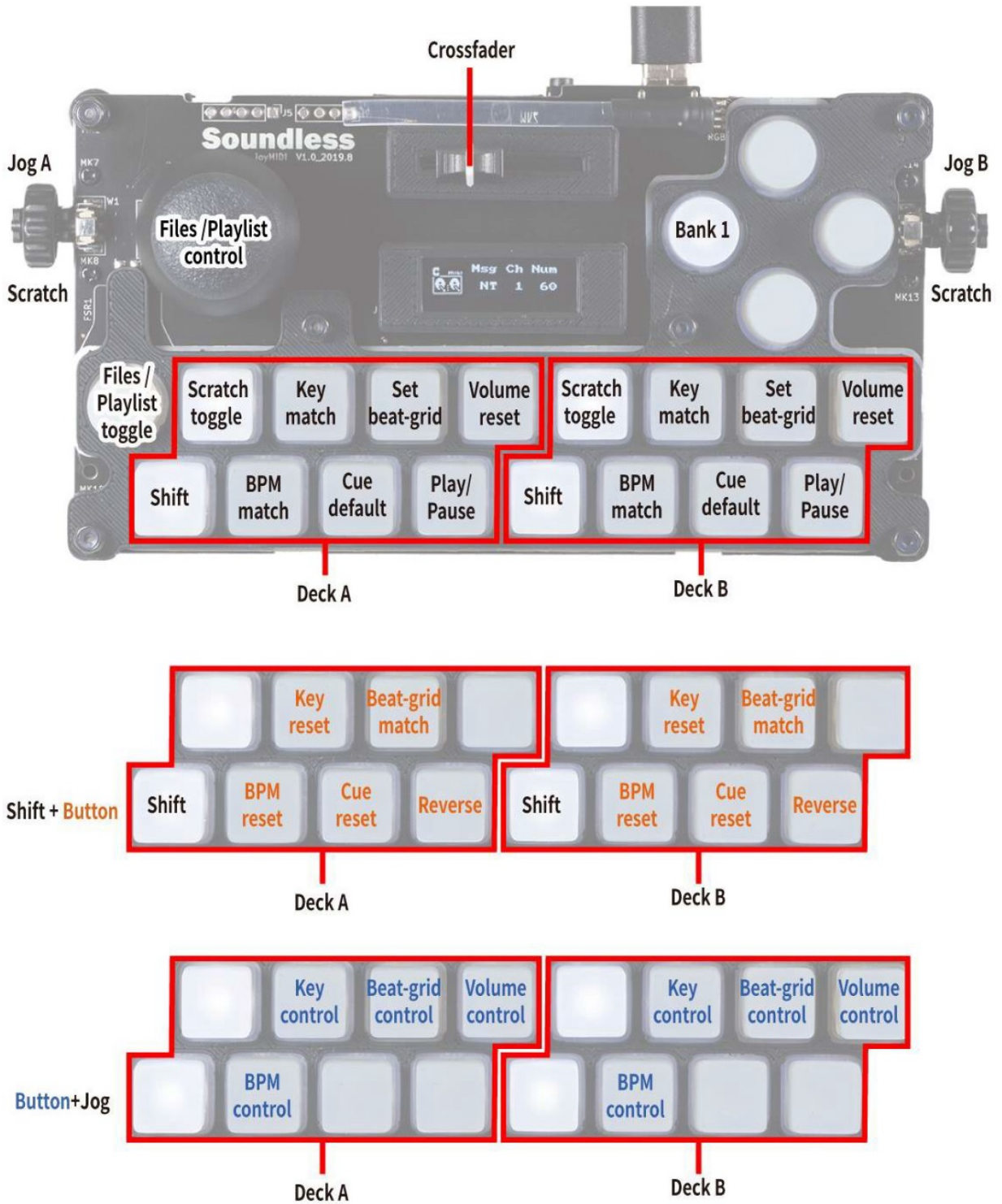

Figure75: Soundless Studio joyMIDI (bank 1)



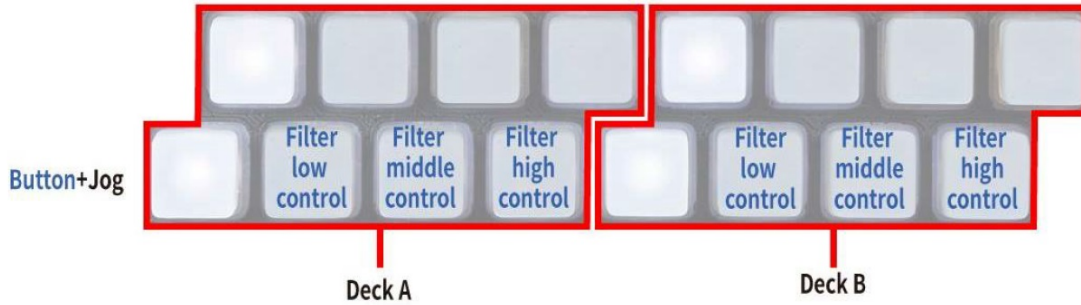
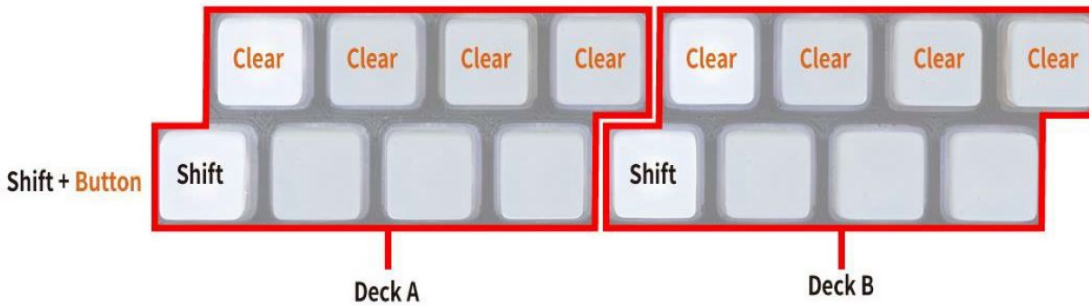
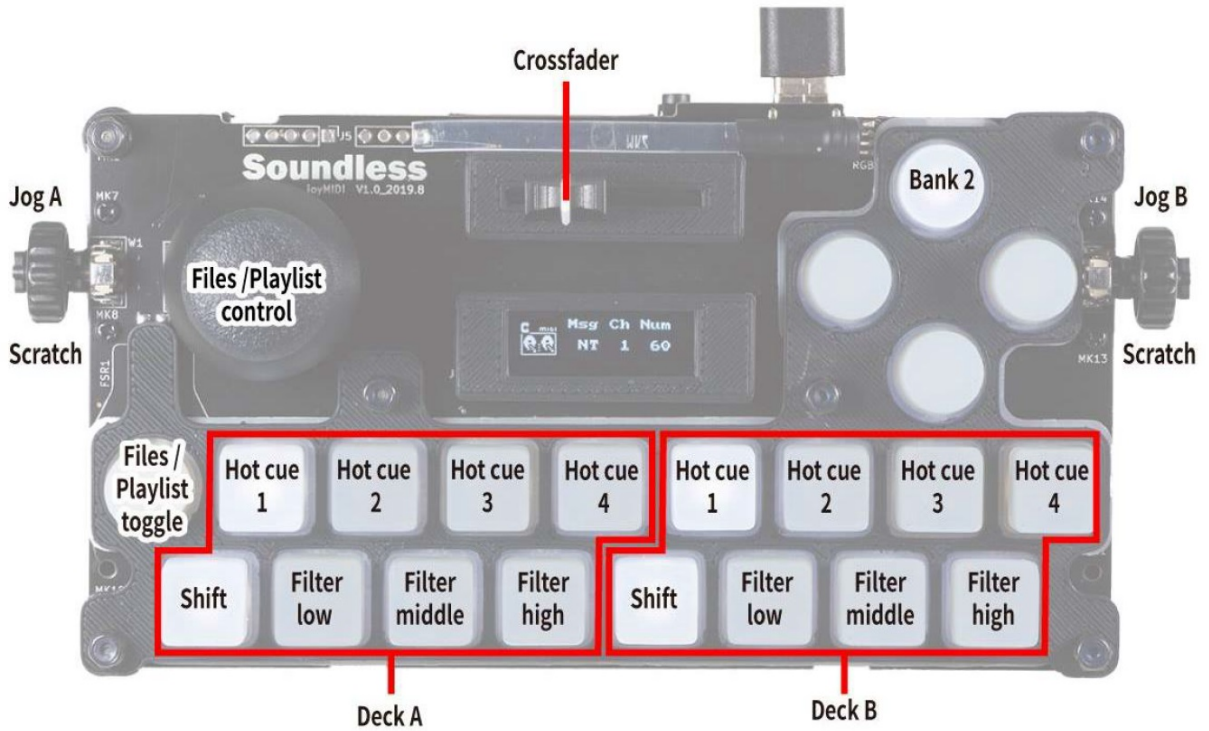

Figure76: Soundless Studio joyMIDI (bank 2)

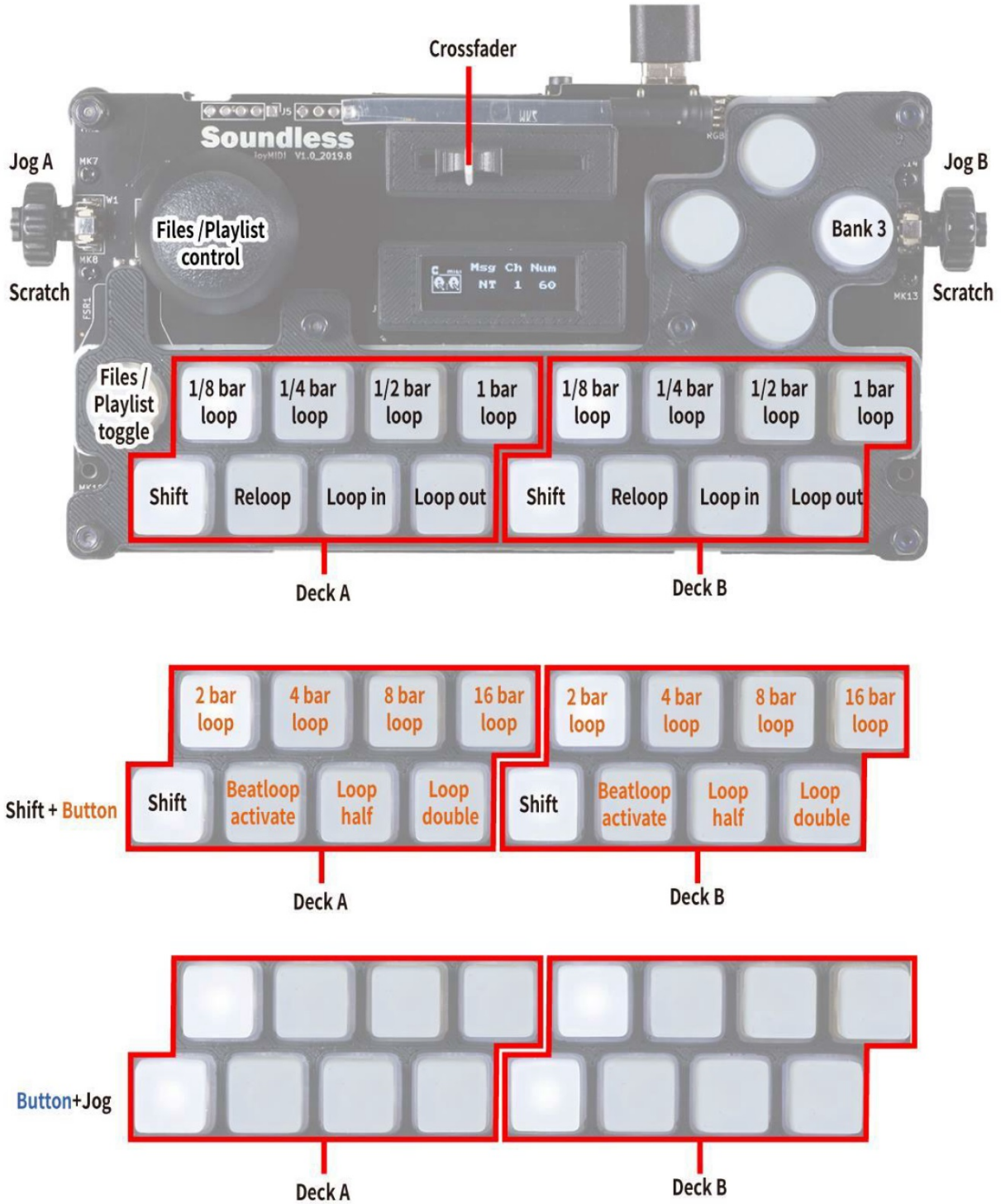

Figure77: Soundless Studio joyMIDI (bank 3)

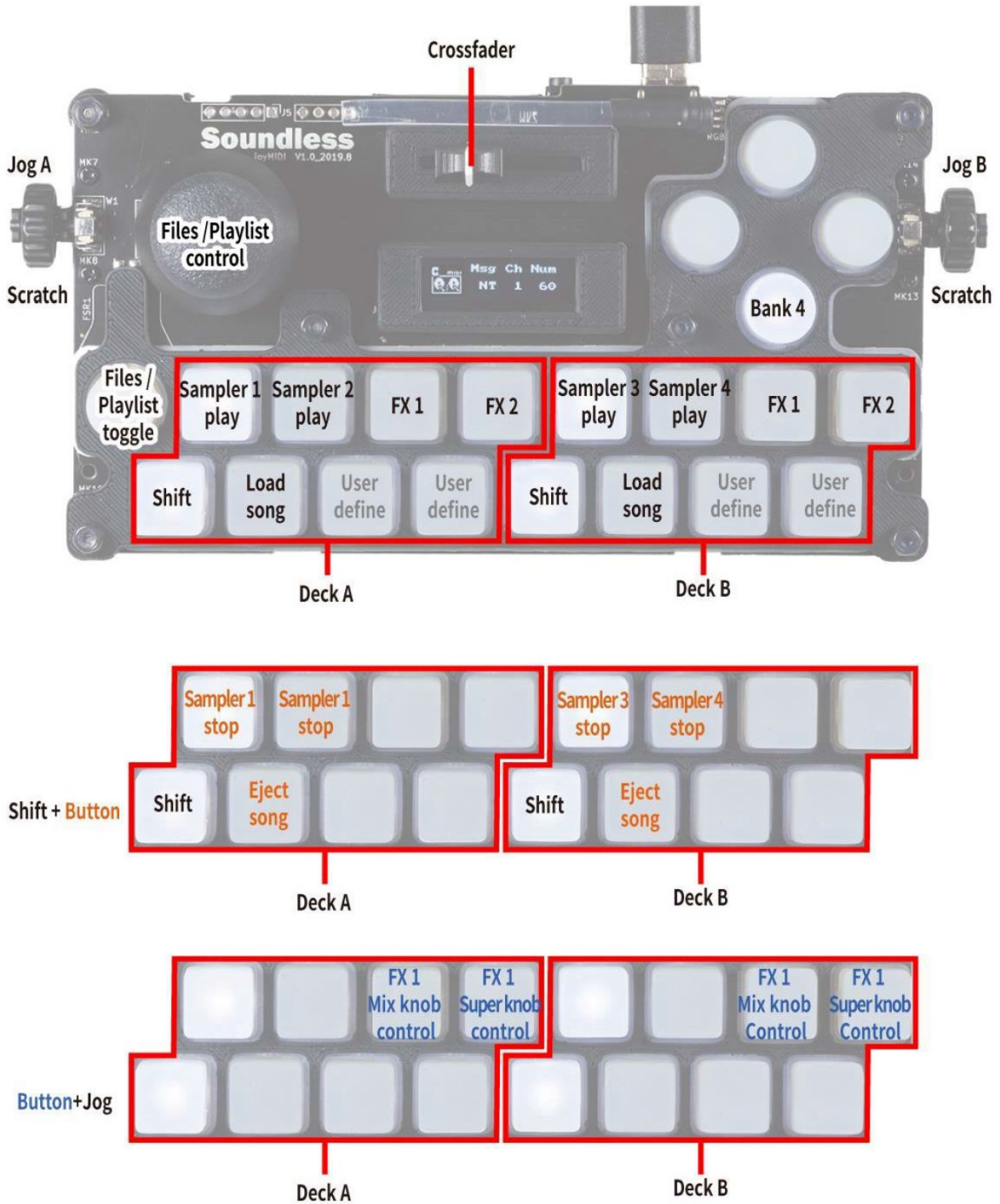

Figure78: Soundless Studio joyMIDI (bank 4)



## Bank 4

### 17.1.109 Stanton DJC.4

- [Manufacturer's product page](#)
- [Manual / Midi commands](#)
- [Forum thread](#)

Nuovo nella versione 2.2.4.

#### Compatibility

This controller is a class compliant USB MIDI and audio device, so it can be used without any special drivers on GNU/Linux, Mac OS X, and Windows. However, if you wish to use the *ASIO sound API* under Windows, please install the latest driver package available from the [Product page](#).

#### Sound card setup

This controller has a built-in 4 channel sound card, with MASTER output (RCA and balanced 6.3 mm TRS) and HEADPHONE output (6.3 and 3.5mm jack).

| Output Channels | Assign to  |
|-----------------|------------|
| 1-2             | Master     |
| 3-4             | Headphones |

| Input Channels | Assign to                |
|----------------|--------------------------|
| 1-2 (Input 1)  | Vinyl Control 1 or Aux 1 |
| 3-4 (Input 2)  | Vinyl Control 2 or Aux 2 |

Above the **Gain** knobs are switches to select which input should be sent to the PC. For input 1 this can be Aux (3.5 mm TRS) or Line/Phono 1/2 (RCA) and for input 2 this can be microphone (6.3 mm TRS on front) or Line/Phono 3/4 (RCA).

#### Input 1 routing

On the rear side is a small switch to select if Input 1 is routed to the PC or directly to the master output (through). It is therefore possible to include the microphone into a recording/stream or to exclude it.

#### Vedi anche:

The *example setups section* provides more details about the audio configuration in Mixxx.

## Hardware controls

The **Master** and **Mic Level** are hardware controls and interact directly with the integrated sound card and are not mapped to Mixxx.

### Vedi anche:

The *gain staging documentation* explains how to set your levels properly when using Mixxx.

## Mapping description

The knobs for MASTER LEVEL, MIC LEVEL and the MIC ON/OFF switch are controlling the hardware mixer of the built-in audio interface. Hence, turning the knobs will not change values in the Mixxx *GUI* and you'll need to set the Mixxx knobs to their default values when using the controller.

## Controls

### Center section

| No. | Control                        | Function  |
|-----|--------------------------------|---|
| 1   | SAMPLER VOLUME knob            | Change the volume of all eight samplers at the same time. If the SAMPLER VOLUME is at zero hide the sampler bank. |
| 2   | BROWSER Rotary encoder         | Turn to move tracklist/sidebar cursor up/down. Press to toggle between sidebar and tracklist.                     |
| 2   | SHIFT + BROWSER Rotary encoder | Turn to move tracklist/sidebar cursor page wise up/down. Press to (Un-)Maximizes the library view.                |
| 3   | LOAD buttons                   | Load song into active deck (Depending on Deck select).  |
| 3   | SHIFT + LOAD buttons           | Open/close a tree view. Equivalent to pressing the LEFT/RIGHT key on the keyboard                                 |

### Mixer section

| No. | Control                                     | Function  |
|-----|---|---|
| 1   | GAIN knobs                                  | Adjust the deck gain (prefader)   |
| 2   | HI, MID, LOW knobs                          | Adjust the high/mid/low-frequency regions of the song. Press to kill this frequency region. |
| 3   | SHIFT + LOW knob                            | QuickEffect superknob (filter by default). Press to (de-)activate QuickEffect.              |
| 4   | Channel CUE buttons                         | Toggle PFL for each channel.  |
| 5   | Channel faders                              | Adjust the output level for each channel.   |
| 6   | Cross fader                                 | Fades between left and right deck.  |
| 7   | Level indicator                             | Indicate the output level of master.  |
| 8   | CROSSFADER CURVE (front side of controller) | Adjust crossfader curve between fade and cut.   |
| 9   | HEADPHONES MIX (front side of controller)   | Adjusts the cue/main mix in the headphone output.   |
| 10  | HEADPHONES LEVEL (front side of controller) | Adjusts the headphone output gain.  |

**Deck section**

| No.       | Control                        | Function   |
|-----------|--------------------------------|--|
| 1         | Jog dial (top surface)         | Perform scratch operation if Scratch is enabled.   |
| 1         | Jog dial (outer edge)          | Rotate to lower/raise playback speed if Scratch is enabled (and pitch if key lock is off). |
| 1         | SHIFT + Jog dial (top surface) | Search fast through the playback location.   |
| 2         | SCRATCH button                 | En-/Disable scratch function   |
| 3         | SHIFT button                   | Hold down to access other functions.   |
| 4         | SYNC button                    | Match tempo and phase of other deck.   |
| 4         | SHIFT + SYNC button            | Plays the track reverse as long as pressed.  |
| 4         | TAP button (tap repeatedly)    | Set tempo by tapping on each beat.   |
| 5         | CUE button                     | Specifies, plays or recalls temporary cue point.   |
| 5         | SHIFT + CUE button             | Jumps to the cue point and stops.  |
| 6         | PLAY/PAUSE button              | Plays or pause the song.   |
| 11        | DECK select buttons            | Switches the deck (left: decks 1 and 3, right: decks 2 and 4)                              |
| 12        | KEY LOCK                       | Toggle key lock.   |
| 12        | SHIFT + KEY LOCK               | Toggle beats quantization.   |
| 13        | Tempo slider                   | Adjust song playback speed (and pitch if key lock if off).                                 |
| 14        | PITCH BEND +                   | Holds the speed one step (4 % default) higher while pushed.                                |
| 15        | PITCH BEND -                   | Holds the speed one step (4 % default) lower while pushed.                                 |
| 14,<br>15 | SHIFT + PITCH BEND             | <i>Not mapped.</i>   |
| 16        | HOT CUE                        | Set (if empty) or Play Hot Cue Point.  |
| 16        | SHIFT + HOT CUE                | Unset/Delete Hot Cue Point   |

**Loop section**

| No. | Control                        | Function  |
|-----|--------------------------------|---|
| 1   | IN                             | If loop is disabled, sets the player loop in position to the current play position. If loop is enabled, press and hold to move loop in position to the current play position.   |
| 1   | SHIFT + IN                     | Seek to the loop in point.  |
| 2   | OUT                            | If loop is disabled, sets the player loop out position to the current play position. If loop is enabled, press and hold to move loop out position to the current play position. |
| 2   | SHIFT + OUT                    | Seek to the loop out point.   |
| 3   | ON                             | Toggles the current loop on or off. If the loop is ahead of the current play position, the track will keep playing normally until it reaches the loop.                          |
| 3   | SHIFT + ON                     | Activate current loop, jump to its loop in point, and stop playback.  |
| 4   | DELETE                         | Not mapped.   |
| 5   | LOOP LENGTH /                  | Halves beatloop size.   |
| 6   | LOOP LENGTH X                  | Doubles beatloop size.  |
| 7   | BEAT MULTIPLIER encoder        | Turn to move the loop left or right by 1 beat per click.  |
| 7   | BEAT MULTIPLIER button         | Sets a loop using the current beatloop size long and enable the loop.   |
| 7   | SHIFT + BEAT MULTIPLIER button | Activates a rolling loop using the current beatloop size.   |

## Sampler section

| No. | Control                  | Function  |
|-----|--------------------------|---|
| 1   | SAMPLER 1-4 (left deck)  | Controls Samplers 1-4 (independent of deck selection) |
| 2   | SAMPLER 1-4 (right deck) | Controls Samplers 5-8 (independent of deck selection) |

## Effect section

| No. | Control        | Function   |
|-----|----------------|--|
| 1   | ON             | Toggle FX 1 for decks 1/3 (both on the left) and FX 2 for decks 2/4 (both on the right). |
| 2-5 | <i>Various</i> | See <a href="#">Standard effects mapping</a> .   |

## Tweakables

At the top of the file `file:Stanton-DJC-4-scripts.js` there are a few customizable options to change the default mapping.

| Variable                        | Function  | De-<br>fault       |
|---------------------------------|---|--------------------|
| <code>autoShowFour-Decks</code> | If a track gets loaded into deck 3 or 4, automatically show four decks in Mixxx | <code>false</code> |
| <code>showMasterVu</code>       | If set to false, show channel VU meter instead of Master L/R                    | <code>true</code>  |
| <code>dryWetAdjust-Value</code> | Amount the <code>dryWetKnob</code> changes the value for each increment         | <code>0.05</code>  |

## Known Issues

The following controls are currently not mapped:

- Loop Delete button (no matching function in Mixxx)
- X-Fader Link button
- Smart Fade button
- Smart button (Shift + Scratch)
- Video button (Shift + Smart Fade)
- FX Ctrl 1/2 fader (Shift + Channel fader)
- TX/FX Select rotary encoder
- TX/FX Action rotary encoder button

### 17.1.110 Stanton SCS.1d

- [Manufacturer's product page](#)

Nuovo nella versione 1.9.1.

#### Mapping description

**Easy customization:** We have provided the following customization variables at the top of the script you can set to your liking:

- **pitchRanges** - The pitch ranges selectable with the Range button. You can add more as you like but they must be in ascending order.
- **fastDeckChange** - If set to true, changes decks instantly by skipping the flashing lights. Useful for beat juggling on one unit.
- **globalMode** - If true, the unit will stay in the current section modes on virtual deck changes (instead of switching to the modes you were in the last time you controlled that virtual deck.) The trigger pad section always stays in the current mode regardless of this setting.
- **platterSpeed** - The speed of the platter at 0% pitch: 0=33 RPM, 1=45 RPM
- **deckChangeWait** - Time in milliseconds to hold the Deck Select button down to avoid changing decks
- **padVelocity** - If set to true, uses the velocity values when recalling cues on the trigger pads (this is toggle-able with a button on the unit as well.)
- **crossFader** - If true, uses the pitch slider to adjust the cross-fader while the Pitch Range button is held down
- **browseDamp** - Number of platter ticks to move the highlight one item when browsing the library. Set higher for slower movement. (Defaults to 3.)
- **looseLoops** - If true (default,) causes the loop buttons to set new loop points each time you press them (good for loop rolls.) If set to false, you must explicitly delete one before you can set another.

Just open the `midi/Stanton-SCS1d-scripts.js` file in your favorite text editor (Wordpad works too) and you'll see these variables right near the top. Edit & save, then restart Mixxx and enjoy.

Now let's take a look at how the controls operate, starting in the upper left and moving counter-clockwise:

#### Mode switch buttons

- **Setup:** *unused by Mixxx but will enter the deck's internal setup menu*
- **Control:** *unused*
- **Browse:** Allows browsing the library with the platter. Press additional times to change the category (Library, Playlists, Crates, etc.) To go backwards, press another mode button (Vinyl or Control) then Browse again.
- **Vinyl:** Take a guess! :-)
- **⇒/Enter:** Loads the currently selected track into the currently selected virtual deck
- **Deck Select:** Switches to the other virtual deck
- **⇐/Cancel:** *unused*

## Transport section

- **circle button:** Toggles headphone cue
- «: Fast rewind
- »: Fast forward
- |«: *unused*
- »|: *unused*
- **Cue, Sync, Play/Pause:** as labeled
- **BPM:** BPM tap

## Trigger Pad section

The trigger pads are used to set and recall hot cues. You can use them as you would a sampler if the target deck is stopped (where it will only play as long as you are pressing the pad) or as hot cues (if the target deck is playing.) You set a cue simply by pressing an unlit pad at the desired point. It lights green when there's a cue set and the corresponding display shows the cue point in `minutes:seconds.centiseconds` format.

- **circle buttons** *above the displays: unused*
- **circle button** at the top right of the section:
  - Velocity toggle: When lit red, the target deck's volume will be adjusted by how hard you strike the pads. Press this button to toggle the feature.
  - Delete cues: Hold this button down and press a pad to delete the cue stored there
- **circle buttons** at the bottom right of the section: These select the cue bank for each deck. The top button chooses the bank for deck one and the bottom for deck two. There are three banks for each deck denoted by the button color: green (1), red (2), and amber (3). In this way you can recall cues/play samples on either deck at any time regardless of what the rest of the controller is doing.

## Pitch slider section

- **Pitch slider:**
  - Pitch adjust: directly corresponds to the slider on screen for the currently selected virtual deck. Since the slider is motorized, it will move on its own if you change decks or adjust the slider on the screen.
  - Cross-fader adjust: will move to and allow adjustment of the on-screen cross-fader while the Range button is held down.
- **Range button:**
  - Toggles between the pitch range values specified in the `pitchRanges` global variable mentioned at the top of this page
  - When held, allows the pitch slider to be used to adjust the cross-fader (if the `crossFader` variable is set to true.) If you do this, the pitch range will not be changed when you release the button.
- **Reset button:** Resets the slider to the center position when adjusting pitch or the cross-fader.

## Preset section

This section has three banks, selected by the three circle buttons at the bottom of the section.

## Loop mode

Press the top circle button (Bank 1) at the bottom of the section to get into this mode. The 12 preset buttons are grouped in pairs with the left one adjusting the loop in point and the right one adjusting the loop out point.

There are two modes of operation selectable by the **looseLoops** global variable described at the top of this page:

1. **Loose Loops mode** - Works just like a CDJ and the on-screen loop controls. Use this for loop rolls.
  - **Left loop button** - Sets loop in point any time you press it
  - **Right loop button** - Sets loop out point any time you press it
  - **Reloop/Exit:** Hold the **Bank 1** button and press either Left or Right loop buttons to toggle the loop on and off
2. **Protected Loops mode** - Works like the hot cue section in that you must first delete a loop point before you can set another. Use this when you want to return to a pre-set loop and not worry about accidentally losing it.
  - **Left loop button** - Sets loop in point only when none is already set
  - **Right loop button** - Sets loop out point only when none is already set
  - **Reloop/Exit: Both loop buttons together** - Toggles the loop on and off
  - **Delete:** Hold the **Bank 1** button and press a Left or Right loop button to delete that loop point.

## Instant pitch changes

The bottom two banks are used for instant pitch changes for the current virtual deck. These are useful when using the pads as samplers to further vary the sounds.

They offer the following arrangements, increasing from left to right, top to bottom:

- **circle buttons** at the bottom:
- **Middle: Key change** - Center row buttons are one semitone away from their vertical neighbors and the outside ones are three semitones away (for harmonic key changes.)
- **Bottom: Notes** - Buttons correspond to major scale notes (ala Vestax Controller One.) This is most useful with a constant-pitch sound or chord. (You can generate one in Audacity, or use the time code sound. :-)

Remember you can return to the original pitch (tonic) by pressing Reset just above the pitch slider.

Note that when you use one of these buttons, the pitch range is automatically set to 100% in order for the values to be set correctly.

*Key change and Note modes were tuned with respect to 440Hz A (above middle C.)*

## Encoder section

Pressing any of the encoders returns the parameter to the default value.

- **circle button** to the left of the section: changes the parameter bank the encoders adjust:
- **Green:**
  - **1st encoder** (from the left): adjusts low frequency equalizer
  - **2nd encoder:** adjusts mid frequency equalizer
  - **3rd encoder:** adjusts high frequency equalizer
  - **4th encoder:** adjusts deck volume
  - **circle buttons** under each display: momentary kill buttons for the corresponding parameter
- **Red:**
  - **1st encoder** (from the left): adjusts flanger depth
  - **2nd encoder:** adjusts flanger delay
  - **3rd encoder:** adjusts flanger period (Low Frequency Oscillator)
  - **4th encoder:** adjusts pre-fader track gain
  - **circle button** under the 1st display: toggles the flange effect for the current deck.
  - **//circle button** under the 2nd display: unused//
  - **//circle button** under the 3rd display: unused//
  - **circle button** under the 4th display: toggles key lock for the current deck.
- When holding down the **Deck Select** button:
  - **1st encoder** (from the left): adjusts the cue/main headphone mix
  - **2nd encoder:** adjusts the headphone volume
  - **3rd encoder:** adjusts the master balance (pan)
  - **4th encoder:** adjusts the master volume

### 17.1.111 Stanton SCS.1m

- [Manufacturer's product page](#)

Nuovo nella versione 1.7.

**Easy customization:** We have provided the following customization variables at the top of the script you can set to your liking:

1. **faderStart:** If set to *true*, it allows decks to start when their channel or the cross-fader is opened. (This is also toggleable with the topmost button on the controller. See below.)
2. **scratchFactor:** Adjusts the speed of scratching with the select knob. (Defaults to **2**.)

Just open the `controllers/Stanton-SCS1m-scripts.js` file in your favorite text editor (Wordpad works too) and you'll see these variables right near the top. Edit & save.





Figure79: Stanton SCS.1m (top/schematic view). Image courtesy of Stanton Magnetics, Inc., overlay (c) 2009 Sean M. Pappalardo.

## Deck controls

Refer to the image above, top to bottom

- **a** buttons: Sync function: change the pitch of the deck so that its BPM matches that of the other deck (assuming the pitch range is sufficient)
- **b** buttons: Toggle headphone cue
- **Gain, High, Mid, Low** knobs: as labeled
- **Pan** knob: *unused*
- **c** encoders
- Rotate to increase or decrease the pitch range in 1% steps
- Press to toggle the flange effect
- **c** displays: Show the current pitch adjustment percentage. The back light color changes with the pitch range:
  - Green = 1%-25%
  - Orange = 25%-50%
  - Red = 50% and above
- **c A** buttons: Permanently lower the pitch by 1%
- **c B** buttons: Permanently raise the pitch by 1%
- **e** sliders: Pitch adjust
- **e** buttons: Temporarily raise the pitch by 4% for as long as held (pitch bend up.)
- **g** buttons: Temporarily lower the pitch by 4% for as long as held (pitch bend down.)
- **d** encoders
- Rotate to nudge the track either direction (akin to twisting a record spindle)
- Press to toggle reverse playback
- LEDs show current track position
- **d** displays: Show the current track time remaining. They will flash slowly when less than 30 seconds remain, quickly when less than 15 seconds remain.
- **d A** buttons: Rewind
- **d B** buttons: Fast-forward
- **f** sliders: Volume adjust
- **f** buttons: Play/pause
- **h** buttons: Cue

## Global controls

Refer to the image above, top to bottom

- **z** button: Toggle fader start/cue
- **Master, Headphones, Cue Mix** knobs: as labeled
- **Zone**knob: *unused*
- **Gain**knob: *unused*
- **i** knob: Adjust flange effect depth
- **j** knob: Adjust flange effect delay
- **k** knob: Adjust flange effect period (Low Frequency Oscillator)
- **l** knob: Adjust master pan (balance)
- **p**button: *unused*
- **m** button: BPM tap for Deck 1
- **n**button: *unused*
- **o** button: BPM tap for Deck 2
- **Preset** buttons: Hot cue points for the selected deck (**q** button)
- **Bank Down** button: select backward between Library, Playlist, and Browse views
- **Bank Up** button: select forward between Library, Playlist, and Browse views
- **q** button: Change which deck's hot cues are active (**Preset** buttons.) Off is Deck 1, On (red) is Deck 2.
- **r** jog wheel:
- **Browse mode:**
  - Rotate to move the track select highlight
  - Press to load the selected track into the first stopped deck, if any. //(This is [[<https://bugs.launchpad.net/mixxx/+bug/734713>]not working]] in 1.9.x for some reason.)//
- **Control mode:**
  - Rotate to scratch the song on the selected deck
  - //Pressing does nothing//
- **Cancel** button:
- **Browse mode:** Press to load the highlighted song onto deck 1, if it's not currently playing.
- **Control mode:** hold down to enable scratching on deck 1
- **Enter** button:
- **Browse mode:** Press to load the highlighted song onto deck 2, if it's not currently playing.
- **Control mode:** hold down to enable scratching on deck 2
- **//Setup** button: unused by Mixxx but will enter the mixer's internal setup menu//
- **Control** button: Selects scratching mode for the jog wheel
- **Browse** button: Selects track browse mode for the jog wheel

(Any unlabeled controls are not currently used.)

### 17.1.112 Stanton SCS.3d “DaScratch”

- [Manufacturer’s product page](#)
- [Walk-through video!](#)

Nuovo nella versione 1.7.

Nuovo nella versione 2.0: Alternate mapping with many more visual effects (flashing lights) and different behavior.

#### Default Mapping



Figure80: Stanton SCS.3d (layout). *Images courtesy of Stanton Magnetics, Inc.*

**Easy customization:** We have provided the following customization variables at the top of the script you can set to your liking:

- **pitchRanges** - Set the pitch slider range when the Pitch LED is off, blue, purple and red (in decimal values. E.g. 0.08 = 8%, 0.5 = 50%)
- **fastDeckChange** - If set to true, changes decks instantly by skipping the flashing lights. Useful for beat juggling on one unit.
- **spinningPlatter** - If set to true, uses the circle LEDs to *accurately (no sticker drift!)* show the track position in record revolutions, also useful for juggling.
- **spinningPlatterOnlyVinyl** - If set to true, only shows the spinning platter LED in vinyl modes. Otherwise shows in all modes except Loop, Instant Pitch Change and TRIG (because they're used for other things in those modes.)
- **spinningLights** - The number of lights used for the spinning platter effect, 1 or 2. (1 is best for juggling.)
- **VUMeters** - If set to true, shows a VU meter in the circular area for the currently selected deck when in vinyl mode. (Left for deck 1, right for deck 2.)
- **markHotCues** - Set to "blue" or "red" (with quotes) to choose which LEDs mark the stored positions in TRIG & LOOP modes
- **jogOnLoad** - If true, the unit will automatically change to Vinyl (jog) mode after loading a track (from Track Select mode)
- **globalMode** - If true, the unit will stay in the current mode on deck changes (instead of switching to the mode you were in the last time you controlled that deck.)
- **singleDeck** - If you've got more than one MIDI controller, set this to true to have the SCS.3d stay on one deck and make Deck mode non-temporary. *More on this here.*
- **deckChangeWait** - Time in milliseconds to hold the DECK button down to avoid changing decks
- **pitchAdjustment** - Adjusts the coarseness of the pitch slider (1=coarse, 3=normal, 5=fine)
- **finePitchAdjustment** - Adjusts the coarseness of the pitch slider in fine mode (1=coarser, 3=normal, 5=finer)
- **finePitchDefault** - If true, swaps normal and fine pitch modes so you can use fine pitch mode unshifted

Just open the `controllers/Stanton-SCS3d-scripts.js` file in your favorite text editor and you'll see these variables right near the top. Edit & save.

## Mode buttons

- FX - Adjust & toggle Flanger effect, toggle reverse effect
- EQ - Adjust channel EQ parameters
- Loop - Loop controls and Instant pitch changes
- Trig - Hot cues
- Vinyl - Toggle between pitch bend, vinyl manipulation & scratching, and track selection
- Deck - Adjust global controls and switch to another virtual deck

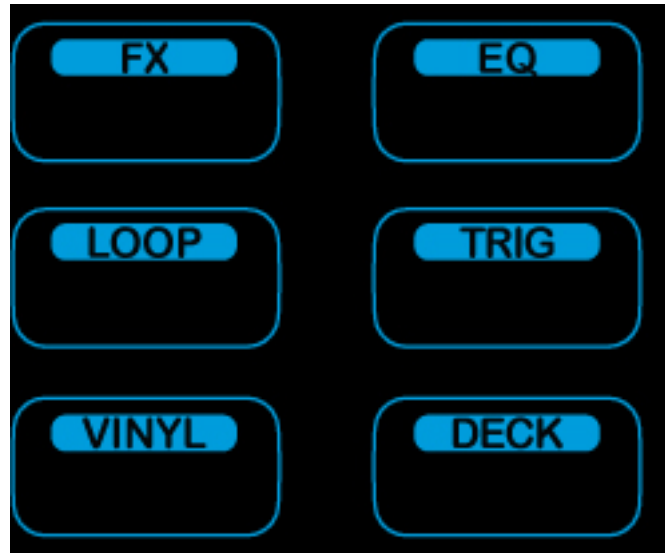

Figure81: Stanton SCS.3d (mode buttons)

**Common to all modes:**

(except where noted)

- Gain slider (S1) adjusts deck volume
- Pitch slider (S2) adjusts deck pitch control
- B11 toggles headphone cue
- B12 toggles pitch range (black=8%, blue=12%, purple=50%, red=100%)
- B13 Rewind (REW)
- B14 Fast Forward (FFWD)
- PLAY starts or pauses track playback.
- CUE will jump to the cue point or set it, depending on your settings and whether the track is playing.
- SYNC synchronizes the tempo of the current deck to another. Holding SYNC for more than 1/3 of a second will enable Master SYNC lock. (Press SYNC again to disable it.)
- Pressing TAP repeatedly will change the speed of the current deck to match your tap tempo (useful for synchronizing with an external music source.)

**While holding down the current mode button:**

- Gain slider (S1) adjusts pre-fader gain
- Pitch slider (S2) finely adjusts pitch control
- B11 resets pre-fader gain to center
- B12 resets pitch to center 0%
- SYNC toggles the *Quantize* function (where Cue and Loop points snap to the nearest beat and triggering them happens in time with the beat.)

## FX Modes

These modes let you adjust the effect unit parameters. The FX button will be red when adjusting effect unit 1, purple for unit 2, and black for unit 3. (In Mixxx versions below 2.0.1, there is only one mode that adjusts the Flanger effect.)

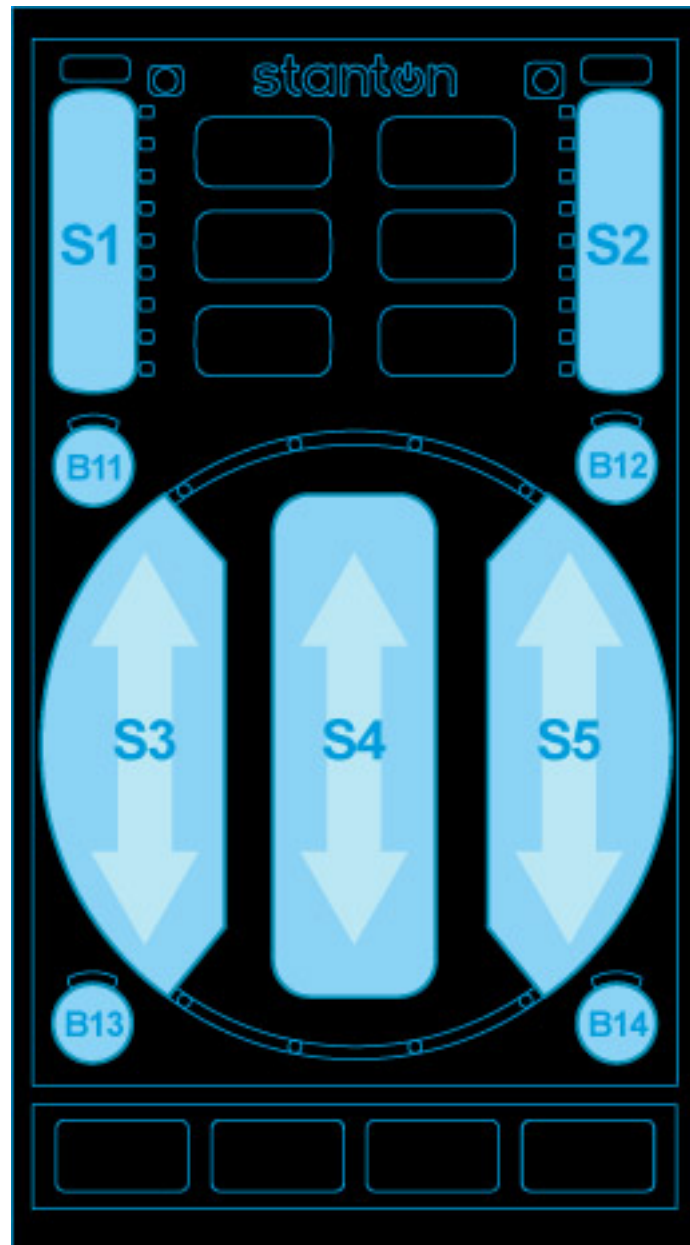

Figure82: Stanton SCS.3d (slider mode)

- Left slider (S3) adjusts the first effect parameter
- Center slider (S4) adjusts the second effect parameter
- Right slider (S5) adjusts the third effect parameter
- B11 performs a reverse-roll (censor) while held down
- B12 toggles this effect on the current deck

Hold the FX button down and touch any slider to reset it to center.

## EQ Mode

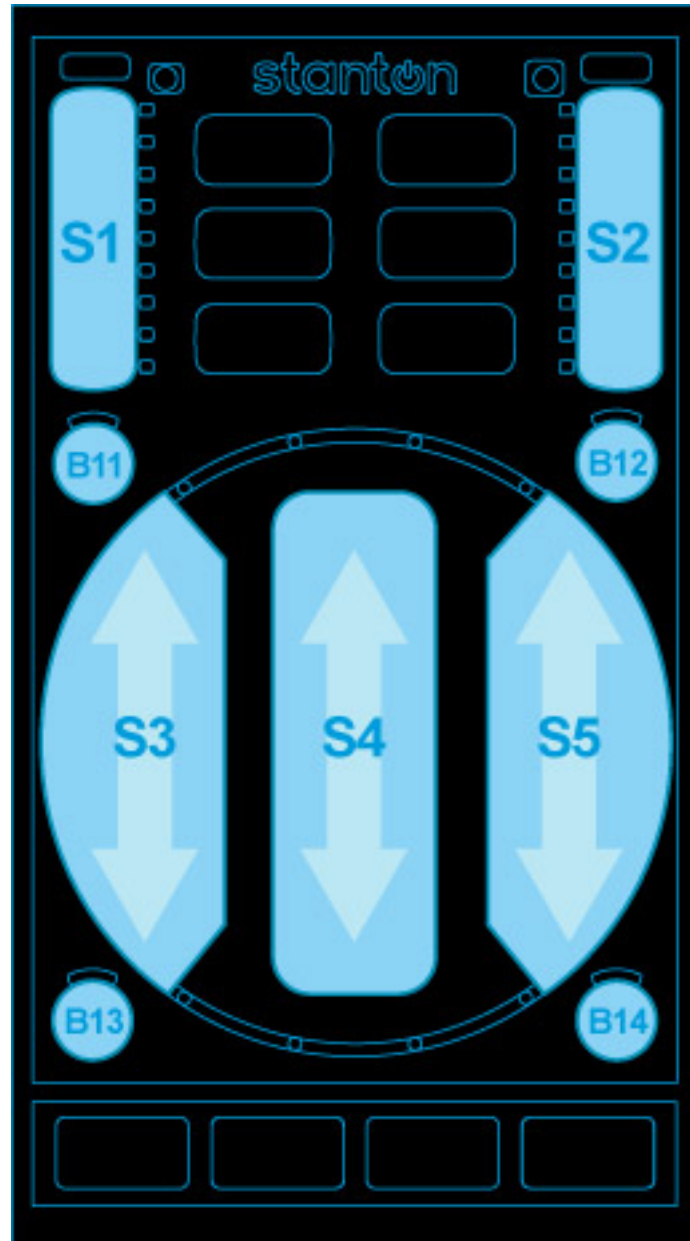

Figure83: Stanton SCS.3d (slider mode)

- Left slider (S3) adjusts low frequency equalizer
- Center slider (S4) adjusts mid frequency equalizer
- Right slider (S5) adjusts high frequency equalizer

Hold the EQ button down and touch any slider to reset it to center.



## Loop mode (red)

The surface is configured as 11 buttons:

| Left          | Middle      | Right        |
|---------------|-------------|--------------|
| 1/8-beat loop | Loop In     | 2-beat loop  |
| 1/4-beat loop | Reloop/Exit | 4-beat loop  |
| 1/2-beat loop | Reloop/Exit | 8-beat loop  |
| 1-beat loop   | Loop Out    | 16-beat loop |

**Mixxx v2.0.1 and above** have the left column flipped so you can adjust the loop size sequentially when moving along the circle:

| Left          | Middle      | Right        |
|---------------|-------------|--------------|
| 1-beat loop   | Loop In     | 2-beat loop  |
| 1/2-beat loop | Reloop/Exit | 4-beat loop  |
| 1/4-beat loop | Reloop/Exit | 8-beat loop  |
| 1/8-beat loop | Loop Out    | 16-beat loop |

The Reloop/Exit button lights up when a loop is active. If it happens to be an exact number of beats, the corresponding beat loop button will light up as well.

Also:

- **B11** (under the Gain slider) halves the length of the current loop
- **B12** (under the Pitch slider) doubles the length of the current loop

You can exit any loop by pressing Reloop/Exit (or a lit beat loop button.)

## Instant-pitch change modes (Loop button)

This offers instant pitch change buttons in the following arrangements:

**Key change (purple)** - Center buttons are one semitone away from their vertical neighbors and the outside ones are three semitones away (for harmonic key changes.)

**Notes (black)** - Buttons correspond to major scale notes (ala Vestax Controller One.) This is most useful with a constant-pitch sound or chord. (You can generate one in Audacity.)

Remember you can return to the original pitch (tonic) by pressing B12 (under the pitch slider.)

Note that when you use one of these buttons, the pitch range is automatically set to 100% in order for the values to be set correctly.

*Key change and Note modes were tuned with respect to 440Hz A (above middle C.)*

**1.7 also offered the following** since looping was not available:

**Fixed increment (red)** - Each button sets the pitch 3.33% above or below its vertical neighbors.

## Trig Modes

These modes configure the surface as three separate banks of 12 buttons (lit up dim red for visibility) giving you a total of THIRTY-SIX hot cues! (Mixxx 1.8.0-1.9.0 internally supports just 32, so the center 4 buttons and the lower right one in the third bank (black) are inoperative. Mixxx 1.9.1+ supports 36 again.) The TRIG button will be red in bank 1, purple in bank 2, and black in bank 3.

The red LEDs flash when you press the corresponding button. The outer blue LEDs light when a cue point is set on that button. (Changeable with the **markHotCues** option mentioned at the top of this page.)

- To set a cue, just press a free button at the desired time.
- To recall a cue, just press a button that has a cue point set
- To erase a cue, hold TRIG while pressing the button(s) you want to erase

## Vinyl Modes

### Vinyl mode (red)

- Outer circle (C1) and Center slider (S4) allow you to bend the song's pitch, akin to dragging your finger on the record

### Vinyl2 Mode (purple)

- Outer circle (C1) allows you to "scratch" the song and perform juggles
- Center slider (S4) allows you to "scratch" the song
- Scratch & cue toggle: Hold the VINYL button and press CUE when in Vinyl2 mode to toggle recalling the cue point when you touch either C1 or S4. This makes juggling really easy since you don't have to back-cue.

### Track Select Mode (black)

- Outer circle (C1) allows you to scroll through your Library
- Center button (anywhere on S4) loads the currently highlighted song into the current deck, as long as it's not live (playing to the master output.)
- B11 selects backward between Library, Playlist, Browse, etc. views
- B12 selects forward between Library, Playlist, Browse, etc. views
- B13 moves the highlight up one item
- B14 moves the highlight down one item

## Deck Mode

You are in this mode only **while holding down the Deck button**, unless the controller is in single-deck mode:

- Gain slider (S1) adjusts master volume
- Pitch slider (S2) adjusts master balance (pan)
- B11 resets master volume knob to the middle
- B12 resets master balance to center
- Left slider (S3) adjusts the cue/main headphone mix
- Center slider (S4) adjusts the cross-fader

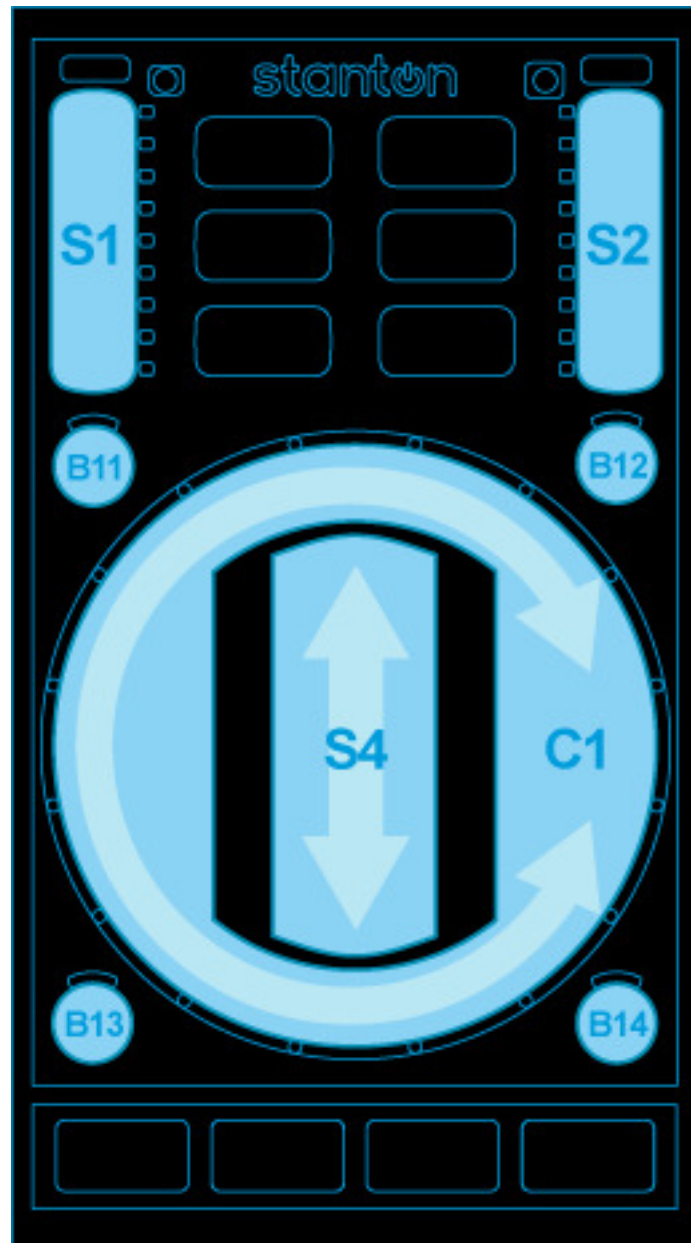

Figure84: Stanton SCS.3d (circle mode)

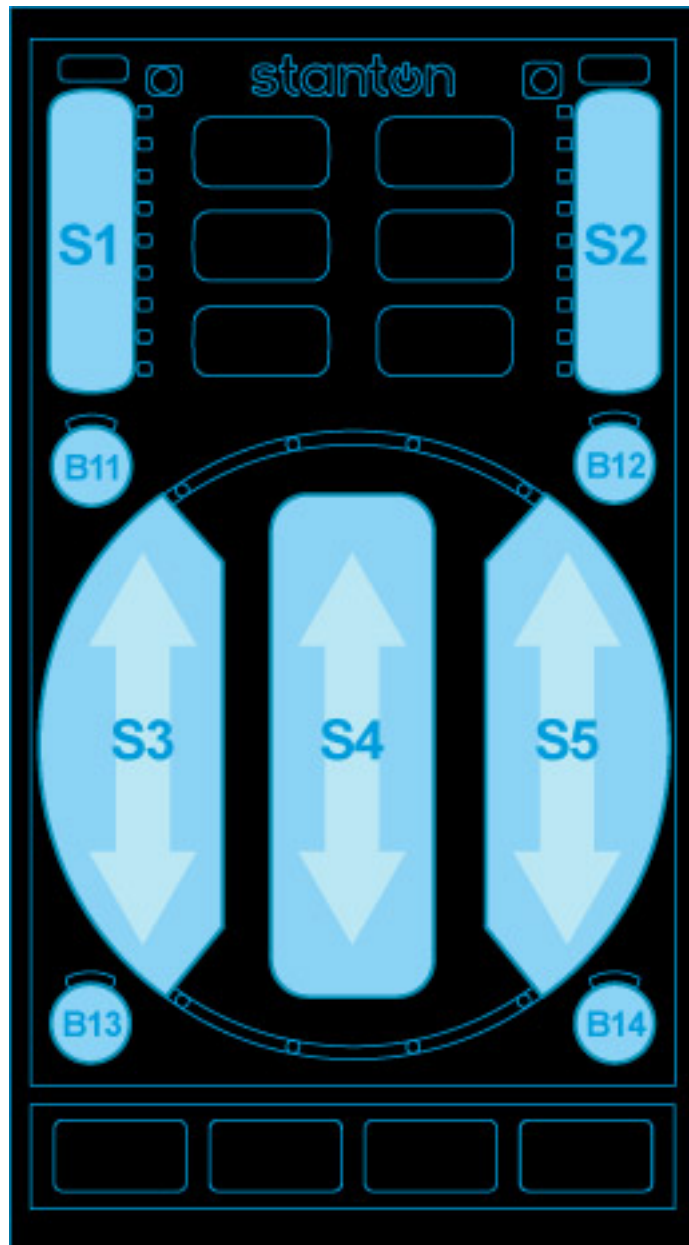

Figure85: Stanton SCS.3d (slider mode)

- Right slider (S5) adjusts the headphone volume
- TAP resets cross-fader to center position (only in multi-deck mode)
- Press Deck + Sync together to toggle between multi- and single-deck modes
- In single-deck mode:
  - Hold the Deck button down and touch any slider to reset it to its default value
  - Press Deck + Play together to change the active deck

## General controls

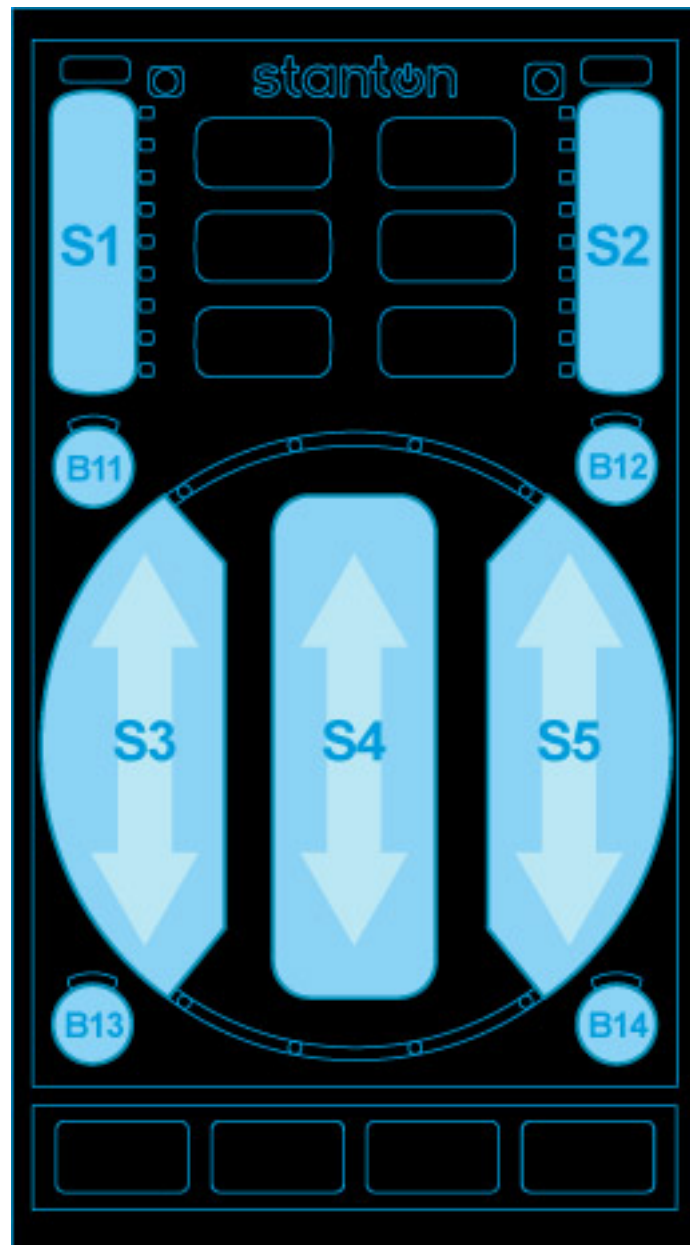

Figure86: Stanton SCS.3d (slider mode)

Unless otherwise noted, the following controls have the same function in all modes.

- S1 controls volume of currently active deck.
- S2 changes rate or pitch depending on current mode, see VINYL-mode for discussion.
- PLAY starts or pauses the track. When a track is ready to play the button blinks.
- CUE will jump to the cue point or set it, depending on your settings and whether the track is playing.
- SYNC syncs the active deck to another deck. Holding SYNC for more than one second will enable SYNC lock.
- Pressing TAP repeatedly will adjust track BPM.

The currently active deck/channel is shown by lighting one of B11 through B14 red (except for FX-mode where the selected FX chain is shown). B11 lights red for deck 1, B12 for deck 2, B13 for deck 3 and B14 for deck 4. See DECK and FX modes on how to control this.

A light spinning around the circle shows the track is playing. When the track nears its end (at -30 seconds), a blinking light will detach and run slower. When the spinning light reaches the blinking light, the track ends.

By touching one of the six mode buttons, you switch to that mode. Some modes have alternate overlays, you can switch to those by touching the mode again. The first overlay is red, the second blue, the third is purple. The following mode-overlays are available:

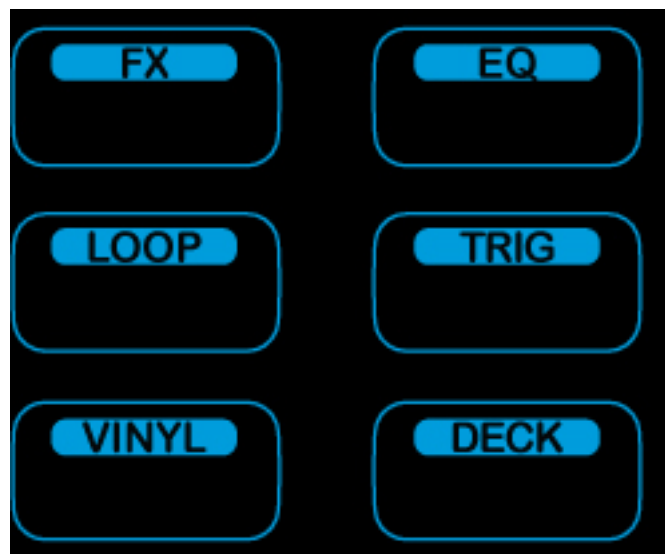

Figure87: Stanton SCS.3d (mode buttons)

- FX: (red) Control effect device; (blue) Control deck superknob
- EQ: (red) Control deck EQ
- LOOP: (red) Set/release beat-loops; (blue) Rolling-loops
- TRIG: (red) cue points 1 through 5; (blue) cue points 6 through 10; (pink) cue points 11 through 15;
- VINYL: (red) jog wheel; (blue) scratch
- DECK: (red) library scan & load

Modes are remembered per-deck. When you switch the deck, the mode last active for that deck will be selected.

By holding a mode button, a mode is enabled temporarily in hold-mode. When the button is released again, the device switches back to the previously selected mode. Some hold-modes enable alternative, often disruptive functionality. Most

of the time you won't want to use the hold-modes on live decks (e.g. needledrop in VINYL) or you must be very cautious (assigning effect chains with FX).

Each mode will be explained in detail below.

### FX mode

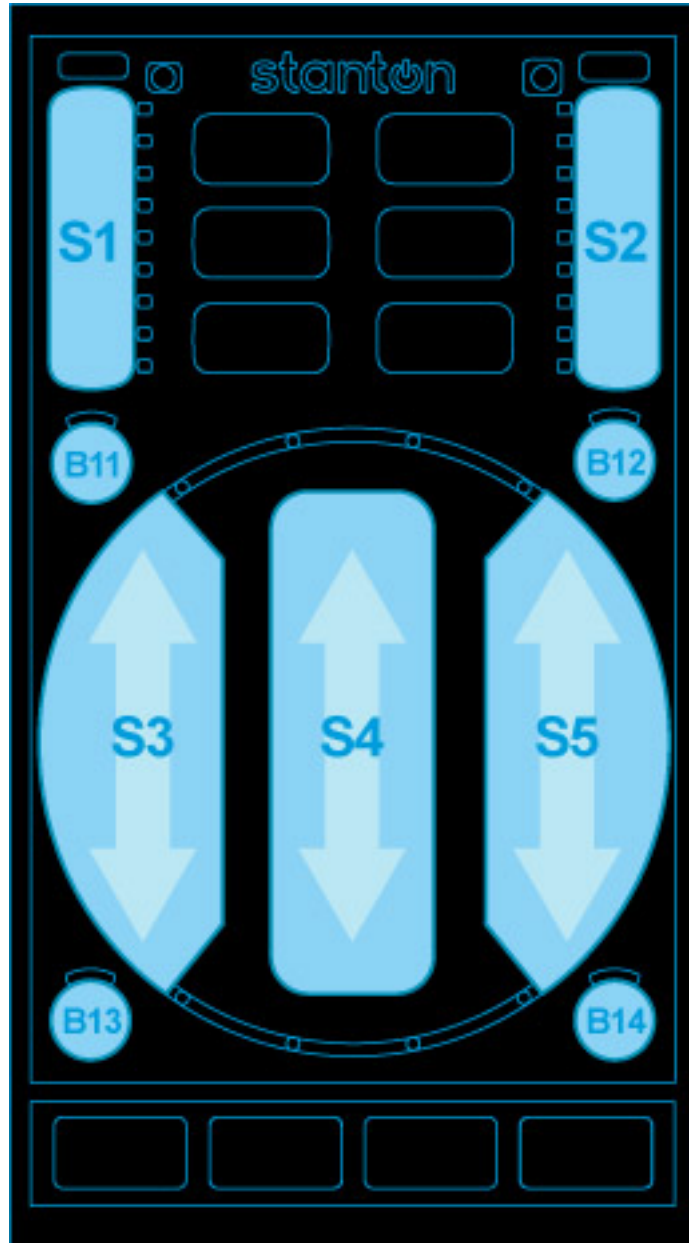

Figure88: Stanton SCS.3d (slider mode)

FX mode allows you to control effects. Slider S2 controls the wet/dry mix of the current effect. Sliders S3, S4, and S5 control the first three effect knobs on the effect unit. (Specifically, the first effect of one of the four effect chains is controlled.)

The device remembers the selected effect per deck, so if you switch decks you also switch to the previously selected effect on that deck. Initially, effect slot 1 is selected for deck 1, slot 2 for deck 2 and so on.

To control another effect, buttons B11 through B14 allow you to switch. The currently active effect is shown in red where button B11 lights red when the first effect chain is selected, B12 for the second chain, B13 for chain 3, and B14 for chain 4. The buttons turn blue when the active deck is assigned to this effect chain. If the active effect is assigned to the current deck, the corresponding button will appear purple. If you don't see purple it means that the effect you're controlling is not assigned to the current deck.

For example, if the controller is on deck 2, has effect slot 2 selected, and effects 2 and 3 assigned, the four buttons would be lit as follows:

- B11: black
- B12: purple
- B13: blue
- B14: black

## Holding FX

By holding FX, you can toggle assignment of the current deck to effect chains with buttons B11 through B14. B11 assigns effect chain 1, B12 assigns effect chain 2, B13 assigns chain 3, and B14 assigns chain 4 to the active deck. The effects that have the current deck assigned are shown in blue. While FX is held, S2 can be used to scroll through different effects. To load the next effect, touch top half of the slider and touch the bottom half to load the previous effect into the currently active effect slot.

When FX is held, the button for the active deck is shown in red. So if you want to assign the active effect to the active deck, press the button that is red. If the button is purple, pressing it would deactivate the active effect on the active deck.

Example on how to load an echo effect into chain 3 and assign it to channel 2:

1. Press DECK-B12 to switch to deck 2
2. Press FX to switch to FX mode
3. Press B13 to select effect chain 3
4. Slide S2 to the bottom to bypass chain 3 (precautionary measure)
5. Hold FX and touch S2 above the middle to select the next effect (will select echo if no effect was selected previously)
6. Hold FX and press B13 to assign effect chain 3 to deck 2
7. Adjust echo parameters with sliders S3, S4, S5
8. Slide S2 upwards to bring the effect in

## EQ mode

In EQ mode, the central sliders S3, S4, S5 control low/mid/high EQs. Hold EQ to control pre-gain on S1 instead of volume. The other controls (low/mid/high/pitch) are reset to center when the control is touched while EQ is held.



## LOOP mode

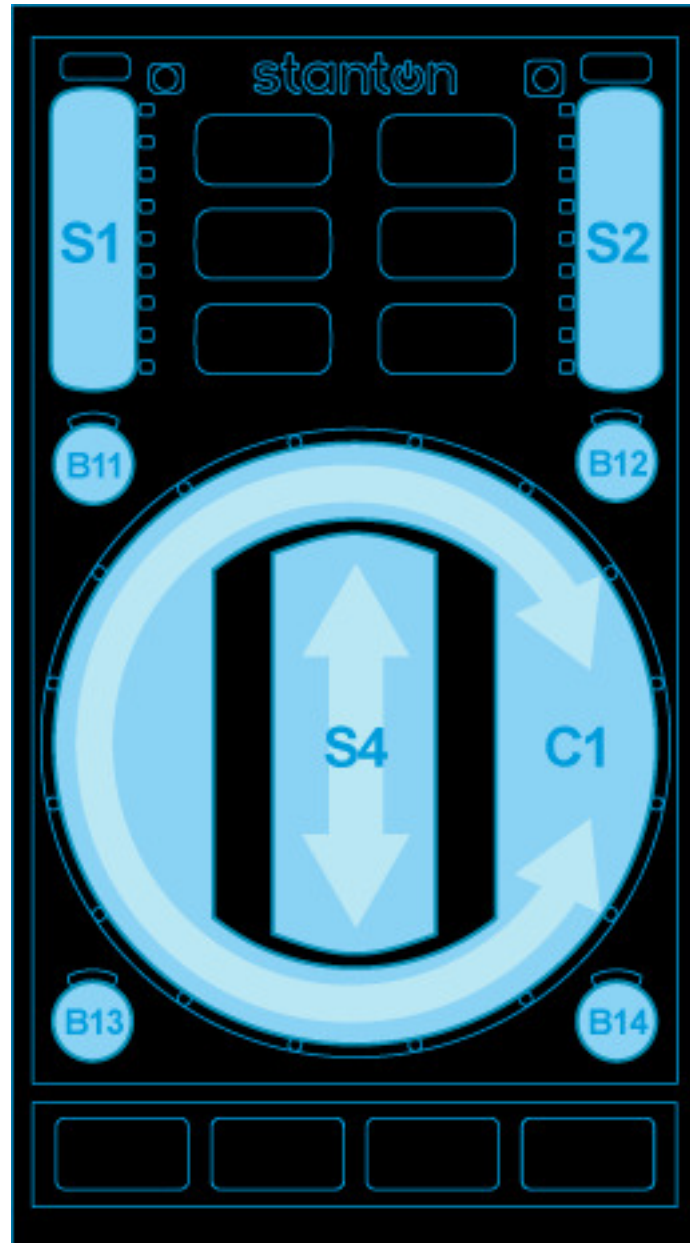

Figure89: Stanton SCS.3d (circle mode)

By touching the circle you activate a loop over a certain number of beats. Touching on the right side will activate a beat-loop over 1, 2, 4, 8 etc beats, starting from the top. On the left side you get fractions 1/2, 1/4, 1/8 etc loops starting from the top. To leave the loop, touch center.

By touching the LOOP mode button again, the 'rolling' overlay comes on and the LOOP button turns blue. In rolling mode, the loop will be released as soon as you take your finger off the circle and the track will resume where it would have been without looping.

## TRIG mode

You can set hotcues and jump to hotcues in this mode. The circle is split into five fields (1: top left, 2: bottom left, 3: top right, 4: bottom right, 5: center) where touching the area will either set the hotcue if it was unset, or trigger the hotcue if it was set. When a hotcue is set, the blue lights next to it will light.

To clear a hotcue, hold TRIG and touch the corresponding field.

The first TRIG overlay (red light) controls hotcues 1 to 5, touching TRIG will switch to overlay two, controlling hotcues 6 to 10 (blue light), then overlay three, for cue points 11 to 15 (purple light).

## VINYL mode

The circle C1 functions as a jog-wheel, slide clockwise to speed-up the track. The center slider S4 can be used to raise and lower speed by holding it above or below center, respectively.

B11 jumps back one beat, B12 jumps forward. B13 and B14 control fast-reverse, fast-forward.

While VINYL is held, B11 through B14 set the pitch slider mode. The currently active mode lights blue. The different pitch slider modes are:

- B11 Absolute rate: The pitch slider directly sets the rate in a wide range
- B12 Discrete Pitch: Change pitch up or down by touching upper or lower part of slider
- B13 Rate: Change the rate up or down by holding the slider off-center. The further from the center you hold the slider, the faster the rate changes.
- B14 Relative pitch: slide to change pitch up or down

When VINYL is held, the SYNC button adjusts the beatgrid. When the track is not playing, the beatgrid is moved to the current track position. When the track is playing, the beatgrid is aligned with the other track's beatgrid.

A second overlay to VINYL (blue) enables scratching on the pad. Both the circle and the center slider (S4) can be used to scratch.

## DECK mode

This mode is used to load tracks. When the current deck is not playing, an arrow pattern indicates that the currently selected track can be loaded into the deck by pressing the central field S4. Sliding on the circle C1 will scroll through the library.

B11 and B13 allow you to switch up and down between the library categories, while B12, B14 allow stepping through the library list one-by-one (the slider allows only coarse control).

When holding DECK, you can switch channels.

- B11: deck 1; B12: deck 2
- B13: deck 3; B14: deck 4

The corresponding button turns red. The active deck is shown on the buttons in all modes except FX.

The controller keeps its mode per deck. So when changing deck, the mode will switch to the mode previously used on that deck.

Note that the active deck is synced with the *Stanton SCS.3m*, so when switching between decks 1 and 3, or 2 and 4 the other device changes as well.

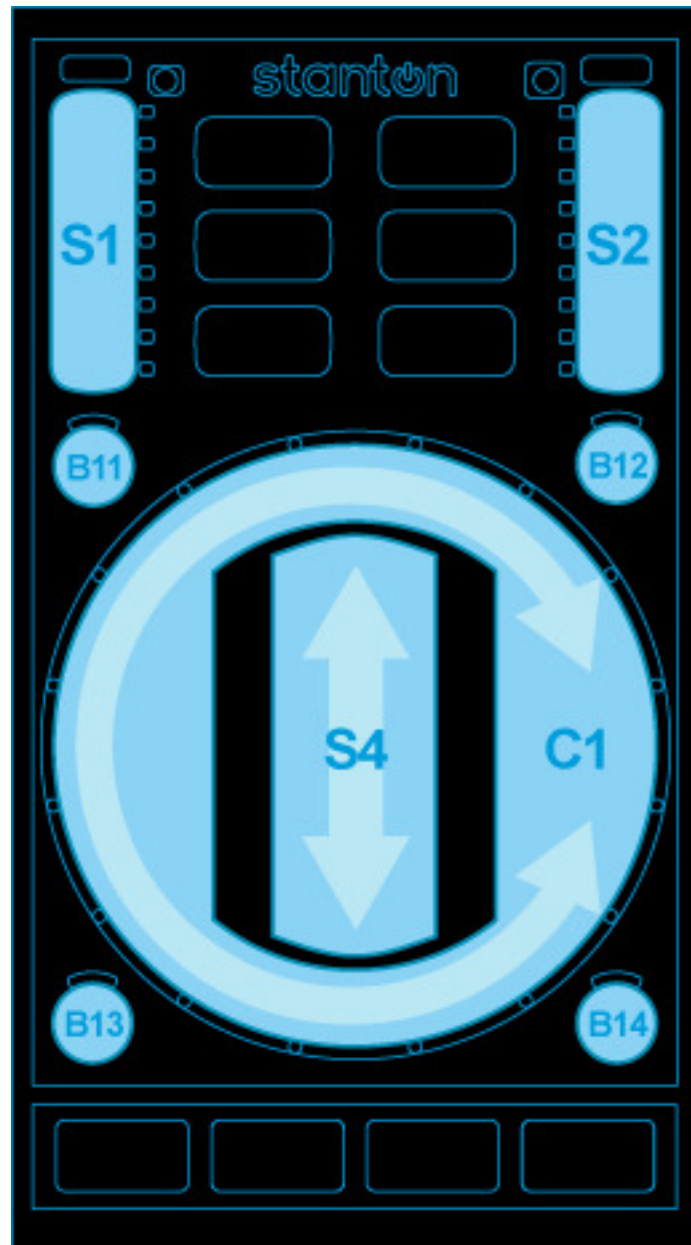

Figure90: Stanton SCS.3d (circle mode)

### 17.1.113 Stanton SCS.3m “DaMix”

- [Manufacturer’s product page](#)

Nuovo nella versione 1.7.

#### Mapping Description

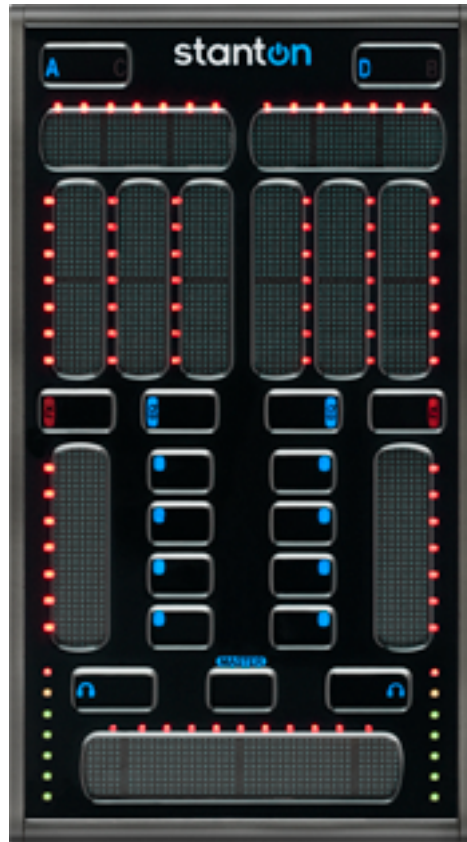

Figure91: Stanton SCS.3m «DaMix» (top view). *Images courtesy of Stanton Magnetics, Inc.*

The left side of the controller controls deck 1. The right side is for deck 2. This I’ll walk through the controller from top to bottom and explain the features.

#### Deck select buttons

These are used only as modifier buttons in Mixxx for now. Hold them down to access different functions for that side of the controller (Deck A/C for the left side virtual deck 1, Deck B/D for the right side, deck 2,) detailed for each control below.

## Top horizontal sliders

These adjust the pitch control.

- Touching near the edges will do a temporary pitch bend in that direction.
- Hold the current mode button down (EQ/FX) and touch the slider on that side to reset it to 0%.
- Hold the applicable Deck select button down when using these sliders to perform fine-grained pitch adjustment.

When the Master button is held down:

- The left slider adjusts the Pre/Main headphone mix
- The right slider adjusts Master Balance
- Also hold the current mode button and touch the slider on that side to reset it to center

## FX/EQ sliders

From left to right, for each side:

- in EQ mode these adjust Low, Mid, and High frequency filters
- in FX mode these adjust Depth, Delay, and LFO for the flanging effect

Hold down the current mode button (FX/EQ) and touch one of these sliders to reset it to center.

## FX/EQ mode buttons

Press these to choose what the sliders above them control. (See above.)

- Hold Deck and press FX to toggle the flange effect for that deck
- Hold Deck and press EQ to auto-adjust the pitch to sync the BPM on this deck with the other one (assuming it was detected correctly on both)

## Volume sliders

These adjust the channel volume as on a traditional mixer.

- Holding Deck causes these to adjust the pre-fader gain for the deck

When the Master button is held down:

- The left slider adjusts the Headphone volume
- The right slider adjusts Master volume

## Soft buttons

From top to bottom on both sides:

- Rewind
- Fast forward
- Cue
- Play

Headphone buttons toggle that deck in the headphone mix.

## Cross-fader

Adjusts the cross-fade between the virtual decks

- Needle drop function: Hold a Deck button to use the cross-fader strip to search through the track loaded on that deck

## Level Meters

These normally show the pre-fader signal for the respective deck. When holding down the Master button, they show the stereo master output meters: left side for the left channel, right side for the right channel.

**NOTE:** The LEDs are calibrated to the VU meters on-screen. If you see a red LED flicker, *you are clipping* and need to reduce the volume or gain to avoid distorted sound and/or speaker damage.

## Deck switching buttons

When touching the “A C” or “B D” buttons, the mixer switches between decks. On the left side, touching “A C” will switch between decks 1 and 3. On the right side, touching “B D” will switch between decks 2 and 4. All controls except for the crossfader then control the selected deck.

Connected SCS.3d modules will follow deck changes. For example if you switch from deck 1 to deck 3 on a SCS.3m, all connected SCS.3d modules who are on deck 1 will also switch to deck 3.

## EQ mode

This is the standard mixing mode where the three EQ sliders control low/mid/high. The top slider controls the filter knob.

Touching EQ will return to EQ mode from the FX modes. Holding EQ and touching a slider will reset it to its preset position. (Unfortunately this doesn't work for FX and MASTER modes.)

## FX modes

Touch one of the four buttons to the side of the gain slider to control one of the effect chains. Top button selects first effect chain and so forth. In this mode, the vertical sliders control the first three knobs of the first effect in the selected effect chain. The top slider controls dry/wet mix.

You can assign FX chains to the deck by holding FX and pressing one of the four buttons next to the gain slider. So to assign FX chain 1 to the current deck, hold FX and press the top button (right below EQ).

When holding FX, the volume slider can be used to adjust channel gain. Hold FX and slide up to make the channel louder. Hold FX-EQ and touch the gain slider to reset gain.

## MASTER mode

When holding the central MASTER button, the left side controls the headphone channel, while the right side controls the master channel.

- Left top slider: Pre/main mix on headphone
- Right top slider: main balance
- Left slider: head gain
- Right slider: master gain
- Buttons: The buttons assign effects to head and master

### 17.1.114 Tascam US-428

This product has been discontinued.

- [Manufacturer's product page](#)

Nuovo nella versione 1.6.2.

---

**Nota:** Unfortunately a detailed description of this controller mapping is still missing. If you own this controller, please consider [contributing one](#).

---

### 17.1.115 TrakProDJ

Nuovo nella versione 1.10.0.

---

**Nota:** Unfortunately a detailed description of this controller mapping is still missing. If you own this controller, please consider [contributing one](#).

---

### 17.1.116 Vestax Spin

This controller has been discontinued as Vestax went out of business in 2014.

- [Forum thread](#)

Nuovo nella versione 1.9.

---

**Nota:** Unfortunately a detailed description of this controller mapping is still missing. If you own this controller, please consider [contributing one](#).

---

### 17.1.117 Vestax Typhoon

This controller has been discontinued as Vestax went out of business in 2014.

- [Manufacturer's product page](#)
- [Forum thread](#)

Nuovo nella versione 1.9.

---

**Nota:** Unfortunately a detailed description of this controller mapping is still missing. If you own this controller, please consider [contributing one](#).

---

### 17.1.118 Vestax VCI-1000 (MixVibes 3DEX Edition)

This controller has been discontinued as Vestax went out of business in 2014.

---

**Nota:** Unfortunately a detailed description of this controller mapping is still missing. If you own this controller, please consider [contributing one](#).

---

### 17.1.119 Vestax VCI-100 MKI

This controller has been discontinued as Vestax went out of business in 2014.

Nuovo nella versione 1.6.

---

**Nota:** Only Firmware version 1.2 is supported by Mixxx.

---

**Nota:** Unfortunately a detailed description of this controller mapping is still missing. If you own this controller, please consider [contributing one](#).

---



### 17.1.120 Vestax VCI-100 MKII

This controller has been discontinued as Vestax went out of business in 2014.

- [Product page in archive.org](#)
- [ASIO driver for Windows in serato.com](#)
- [Forum thread](#)

Nuovo nella versione 2.0.

#### Mapping Description

[Functions] in brackets are executed if a shift button of the deck is pressed. **{Functions} in braces are executed if a shift button of the other deck is pressed.** Changes after the previous version are in bold.

1. **Unfocus EffectSlot of the EffectUnit** [Select EffectUnit1/2]
2. **Focus next EffectSlot of the EffectUnit** [Select EffectUnit3/4]
3. **Meta knob of the EffectSlot1, or if EffectSlotN is focused Parameter1 of it** [Set the link to meta knob][1]
4. **Meta knob of the EffectSlot2, or if EffectSlotN is focused Parameter2 of it** [Set the link to meta knob]
5. **Meta knob of the EffectSlot3, or if EffectSlotN is focused Parameter3 of it** [Set the link to meta knob]
6. **Super knob, or if EffectSlotN is focused Parameter4 of it** [Set the link to meta knob], or if enabled by #33 **Wet/dry mix of the EffectUnit**
7. EQ high
8. EQ mid
9. EQ low
10. **Pitch (up and down to 3 semitones continuously, or in keylock mode discretely)**
11. Filter (**super knob of Quick Effect**)
12. **Gain**
13. Rate [Rate by quantized BPM]
14. Channel fader
15. Cross fader
16. Headphone volume
17. Headphone mix
18. Master volume
19. Scratch [**Brake (if released before full stop, playback resumes)**]
20. Jog (locked in slip mode)
21. Play [**Reverse**]
22. Cue [**Cue and Play**]
23. **Activate [Clear] hotcue1**
24. **Activate [Clear] hotcue2**
25. **Sync mode [Adjust beatgrid to the current playposition]**

26. Keylock mode [**Quantize mode**]
27. Loop by default loop size[2] [Reloop], or in loop *Exit the loop* [*Set loop out position*]
28. Halve default loop size [**Jump backward**], or in loop *Halve the loop*[**Jump it backward**] {**Halve jump size[3] of the other deck**}
29. Double default loop size [**Jump forward**], or in loop *Double the loop*[**Jump it forward**] {**Double jump size of the other deck**}
30. **Enable [Set next effect to] EffectSlot1 of the EffectUnit**
31. **Enable [Set next effect to] EffectSlot2 of the EffectUnit**
32. **Enable [Set next effect to] EffectSlot3 of the EffectUnit**
33. **Enable #6 to control wet/dry mix of [Set next effect chain to] the EffectUnit**
34. Slip mode (affect scratch, brake, pause, reverse, loop and hotcue)
35. PFL [PFL solo] (if headphone mix is cue or master only then switch it)
36. Enable EffectUnit1 [EffectUnit3] for the channel
37. Enable EffectUnit2 [EffectUnit4] for the channel
38. Up: previous **item** and scroll, Down: next **item** and scroll, Left: **previous pane [load to left]**, Right: **next pane [load to right]**, Push: **choose item**
39. Channel select

## Mapping for Mixxx 2.0

[Functions] in brackets are executed if a shift button of the deck is pressed.

1. Set previous effect chain to the EffectUnit [Select EffectUnit1/2]
2. Set next effect chain to the EffectUnit [Select EffectUnit3/4]
3. Parameter1 of Effect1 of the EffectUnit
4. Parameter2 of Effect1 of the EffectUnit
5. Parameter3 of Effect1 of the EffectUnit
6. Wet/dry mix of the EffectUnit
7. EQ high
8. EQ mid
9. EQ low
10. Gain
11. Filter (high pass only)[4]
12. Pitch (semitones only)
13. Rate [Rate by quantized BPM]
14. Channel fader
15. Cross fader
16. Headphone volume
17. Headphone mix

18. Master volume
19. Scratch
20. Jog (locked in slip mode)
21. Play [Adjust beatgrid to the current playposition]
22. Cue [Adjust beatgrid to match another playing deck]
23. Cue and Play [Move beatgrid earlier]
24. Sync mode [Move beatgrid later]
25. Quantize mode [Zoom in waveform]
26. Keylock mode [Zoom out waveform]
27. Loop by default loop size[5] [Reloop], or in loop *Exit the loop* [Set loop out position]
28. Halve default loop size, or in loop *Halve the loop* [Move the loop backward by 1/2 beat]
29. Double default loop size, or in loop *Double the loop* [Move the loop forward by 1/2 beat]
30. Activate [Clear] hotcue1
31. Activate [Clear] hotcue2
32. Activate [Clear] hotcue3
33. Activate [Clear] hotcue4
34. Slip mode (affect scratch, loop and hotcue)
35. PFL [PFL solo] (if headphone mix is cue or master only then switch it)
36. Enable EffectUnit1 [EffectUnit3] for the channel
37. Enable EffectUnit2 [EffectUnit4] for the channel
38. Up: previous track and scroll, Down: next track and scroll, Left: load to left, Right: load to right, Push: load to first stopped
39. Channel select
  1. left-right inverse -> right inverse -> left inverse -> full inverse -> none -> full -> left -> right -> left-right
  2. size < 1/4: LED28 & 29; 1/4 ≤ size < 4: LED28; 4 < size ≤ 64: LED29; 64 < size: LED28 & 29
  3. size < 1/4: LED28 & 29; 1/4 ≤ size < 4: LED28; 4 < size ≤ 64: LED29; 64 < size: LED28 & 29
  4. see [the article](#) or use *Controller Wizard* (choose “Quick Effect Super Knob”) for low-high pass
  5. size < 1/4: LED28 & 29; 1/4 ≤ size < 4: LED28; 4 < size ≤ 64: LED29; 64 < size: LED28 & 29

### 17.1.121 Vestax VCI-300

The VCI-300 is a dedicated USB MIDI controller. It also comes with a built in audio interface with standard 4-in/4-out and headphone connection, which means all you need for DJing is the VCI-300, a laptop and a set of headphones.

This controller has been discontinued as Vestax went out of business in 2014.

- [Forum thread](#)

Nuovo nella versione 1.11.

## Differences between VCI-300 and VCI-300 MKII

In 2010 Vestax made changes to the original VCI-300 that improved the controller. There were *no* changes in the MIDI mapping.

### Volume Boost (Gain Boost)

- Higher output gain level and headphone volume level when supplying power with the optional power adaptor.
- *Important Note:* Optional power supply DC-7 must be used in order to get the boost on the headphones and Master output. Without the power supply the MKII will perform just like the original VCI-300. Also, using the DC-7 on the original VCI-300 will do nothing.

### Optional Vestax Digital Fader (not included)

The VCI-300MKII Cross fader can be upgraded to Vestax’s new magnetic sensor system digital fader CF-X2.

### New Direct Audio Thru

Audio fed to the MIC/AUX input can now be directly sent to the Master outputs with the THRU switch turned ON, minimizing latency of when fed through ITCH.

### New adjust knobs for the JOG sensor control

New JOG sensor adjust knobs for speedy and accurate adjustments.the VCI-300MKII’s JOG wheels have excellent tracking ability,and flexibility for various play styles.You can control songs with analog precision.

### New Mini Head-Phone Jack

The MKII features a 1/8 inch headphone connection along with standard 1/4 inch connection.

## Mapping description

Mixxx supports the VCI-300 out of the box. The mapping for Mixxx closely resemble the original to make the transition easy.

| #  | KEY                  | FUNCTION   |
|----|----------------------|--|
| 01 | Pitch Slider         | Adjusts playback speed.  |
| 02 | Auto Tempo           | Toggle quantize (1.11.0: Trigger beatsync)                               |
|    | Shift + Auto Tempo   | Trigger beatsync (1.11.0: Toggle quantize)                               |
|    | Scroll + Auto Tempo  | Tap BPM. When taped repeatedly, adjust the tracks BPM to the tapped BPM. |
| 03 | Keylock              | Trigger beatsync   |
|    | Shift + Keylock      | Reset pitch to 0.00% (quartz)  |
| 04 | Pitch Shift          | Pitch bend   |
|    | Shift + Pitch Shift  | Fine tune playback speed +/-0.01   |
| 05 | Cue [1-3]/In         | Set/Activate Hotcue  |
|    | Shift + Cue [1-3]/In | Delete Hotcue  |

Table 15 – continua dalla pagina precedente

|       |                       |   |
|-------|-----------------------|---|
| 06    | Scratch               | Toggle scratching on jogwheel   |
| 07    | Out 1/Loop            | Set manual loop in point  |
|       | Shift + Out 1/Loop    | Clear loop point  |
|       | Out 2/Loop            | Set manual loop out point   |
|       | Shift + Out 2/Loop    | Clear loop point  |
|       | Out 3/Loop            | Enable/disable loop   |
| 08    | Shift                 | Holding shift engages shift functions of many of the buttons, secondary functions are printed inside a gr   |
| 09    | Trim                  | This controls the volume of the track before it goes to the EQ and fader.   |
| 10    | Censor                | Temporary play backwards while pressed, resumes from where the playhead would have been if the but  |
|       | Shift + Censor        | 1.11: Toggle reverse playback. Pressing Censor again during reverse playback, will return to normal pla<br>1.12 (work in progress): Enable/disable effect unit with preselected <i>Filter</i> effect. The filter parameter is |
| 11    | Auto Loop             | Enable beatloop of the current beatloop value (default: 4 beats) for tracks that have BPM calculated  |
|       | Shift + Auto Loop     | Enter/Exit beatloop roll  |
|       | Scroll + Auto Loop    | Reset number of beats to 4 if beatloop not active   |
| 12    | Equalizers            | Adjust the gain of the high/mid/low EQ filter.  |
| 13    | Half                  | Halve loop length   |
|       | Shift + Half          | Jump to start of track (while paused)   |
|       | Scroll + Half         | Seek backward (while paused)  |
|       | Double                | Double loop length  |
|       | Shift + Double        | Jump to end of track (while paused)   |
|       | Scroll + Double       | Seek forward (while paused)   |
| 14    | Master Level          | This knob controls the overall output of the VCI-300, ensure this is right down before running the softw  |
| 15    | Monitor Select        | Controls the balance in the headphones between the mix output and the PFL headphone cue   |
| 16    | Monitor Volume        | Controls the volume of the headphones.  |
| 17    | Cue                   | If a cue point is set, jumps to the cue point when pressed.   |
|       | Shift + Cue           | Set the cue point (while playing), clear the cue point (while paused), jump to beginning of track (if no o  |
| 18    | Play                  | Start/Pause playback  |
|       | Shift + Play          | Stutter Play  |
| 19    | Crossfader            | Fades between the left and right channels.  |
| 20    | Input faders          | Control the volume of their respective tracks.  |
| 21/23 | PFL A/B               | Sends the left/right deck to the headphone mix.   |
|       | Shift + PFL A/B       | Load selected track into the deck (while paused) and switch PFL to this deck  |
| 22    | Scroll + Jogwheel     | Scroll playlist (while paused)  |
| 24    | Cursor Up/Down        | Scrolls to the next/previous track in the track table.  |
|       | Cursor Left/Right     | Switches to the next view (Library, Queue, etc.)  |
|       | Tab                   | Toggles (expands/collapses) the currently selected sidebar item.  |
| 25    | Jog (platter touched) | Track search (while paused when scratching is disabled)<br>Pitch bend / nudge (while playing when scratching is disabled)<br>Scratch (when scratching is enabled)   |
|       | Jog (outer rim)       | Pitch bend / nudge  |
|       | Shift + Jog           | Fast track search (while paused)  |
|       | Scroll + Jog          | Scroll playlist (while paused)  |

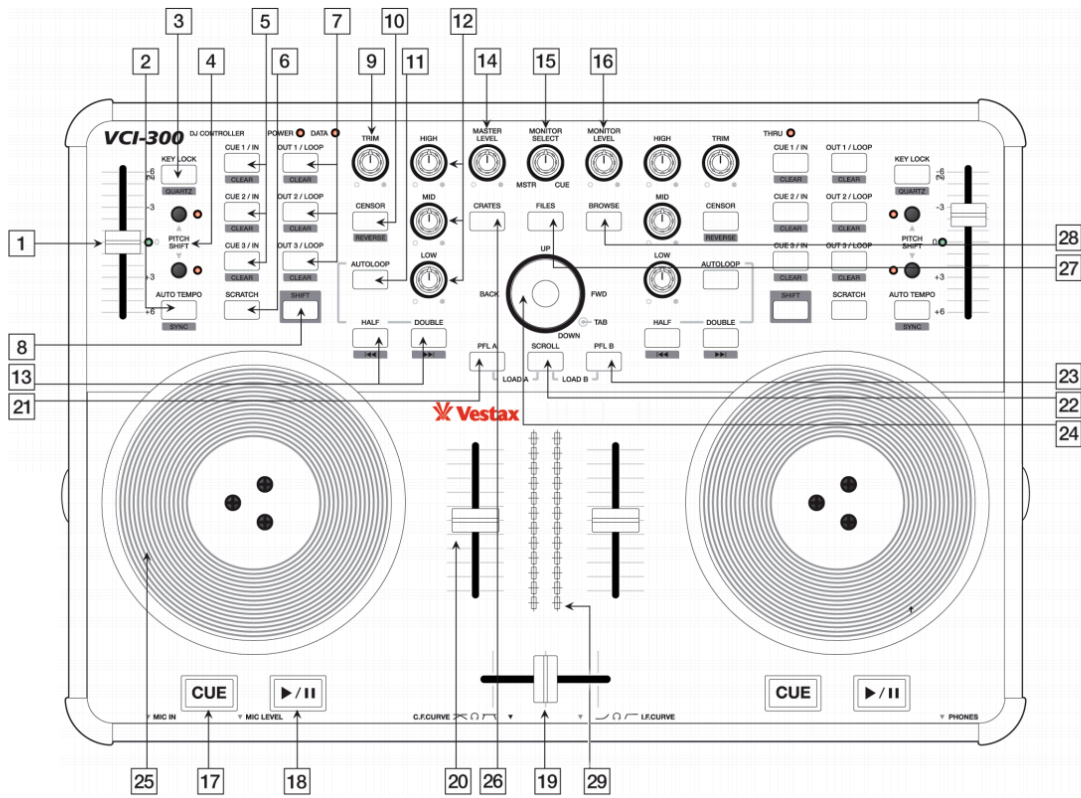

Figure92: Vestax VCI-300 (schematic view) Image (c) Vestax

### 17.1.122 Vestax VCI-400

The Vestax VCI-400 is a 4 deck controller. It has an integrated audio interface with balanced outputs (XLR and 1/4» TRS), two pairs of RCA inputs, and two XLR / 1/4» combination microphone inputs. The microphone inputs can be sent to the computer for recording and broadcasting. The RCA inputs do not have phono preamps and do not work for vinyl control. The VCI-400 requires its own power supply; it does not run on USB bus power.

This controller has been discontinued as Vestax went out of business in 2014.

Nuovo nella versione 1.10.1.

#### Compatibility

The original VCI-400 firmware has a bug that prevents the sound card from working with Linux. Now that Vestax is out of business, drivers and firmware for Vestax devices are hosted on [Serato's website](#). If your VCI-400's sound card does not appear as an available device using Linux, use the firmware updater on a computer running Windows or Mac OS X. This will only need to be done once and then the controller will continue to work with Linux.

Note that the VCI-400 and VCI-400 Ean Golden Edition are incompatible. Their firmwares use different MIDI messages to communicate with the computer. Unfortunately, it is not possible to switch between the VCI-400 and VCI-400 Ean Golden Edition firmware.

#### Mapping

The VCI-400 mapping for Mixxx is based on the Serato Limited Edition overlay.

**For regular use, make sure the “mixer select” switches are all the way to the left.** If you move them to the right, the Play / Cue buttons will be used to select vinyl control modes instead.

Most of the functions are exactly as they appear on the overlay, and the overlay is very nicely labeled so that's the best place to start.

The four small buttons below the grouping of 8 buttons selects which mode the 8 buttons are in, either Hot Cues, Loops, Rolls, or Samples. Mixxx remembers which mode is selected on a per-deck basis, so when you toggle the deck-selection switches the mode may change. The button corresponding to the current mode will be lit so you know what mode you're in.

Button Modes:

- In Hot Cue mode, the 8 buttons will move Mixxx to the designated hotcue. If you hold the shift button, the hotcue will be cleared.
- In Loop mode, the 8 buttons will create a new loop at the current position from size 32nd note to 16 beats.
- In Roll mode, holding any of the buttons will temporarily create a loop anywhere from 32nd note to 16 beats.
- In Sampler mode, both sides of the controller launch the same set of 8 samplers. Holding shift will eject a sample.

Some of the buttons have special functions in Mixxx:

1. The Vinyl / Slip button. While pushed, the jog wheel is in scratching mode (similar to if you push down on the platter). If you hold this button while spinning the jog wheel, you can let go of the wheel and Mixxx will still be in scratch mode. Great for backspins.
2. The Param knob can be used to adjust the musical key of the current track. Twist to make the tone higher or lower. If you hold the shift button (3), use this knob to scroll quickly through the track. Pushing this knob will reset the key.
3. Shift button



Figure93: Vestax VCI-400 (top view with annotations)



4. Auto Loop knob. Twisting this will change the size of the current loop, either doubling or halving the size. If you hold shift (3), twisting this knob will move the loop left or right by 1 beat per click. Pushing this knob will enable or disable looping.
5. The Master FX button enables the 1st FX bank to be applied to the master output.
6. The FX Mode button toggles which effect is in the first FX bank.
7. Controls FX1 Parameter 1
8. Controls FX1 Parameter 2
9. Controls FX1 Parameter 3
10. Controls FX1 Dry / Wet
11. Enable/Disable Quantize Mode.
12. Enable/Disable Keylock

The four small buttons in the center, Area, Panel, Back, and Prepare, don't do anything. Neither does the sampler volume slider.

Some additional functions are accessible with the shift button:

- Shift + Load to eject a track.
- Shift + Play while the deck is playing does a breaking stop.
- Shift + Censor does a spinback stop.

### **Vinyl Control Mode**

If you want to use vinyl control instead of the jog wheels, you can move the mixer selection switches all the way to the right. In this mode, the Play button becomes a Vinyl Control Enable/Disable button, and the Cue button selects which Vinyl Control mode is active – Absolute, Relative, or Constant. The cue button lights up when Absolute is selected.

### **Note about VU Meters**

There's a bug in the way that the VCI400 firmware works – although Mixxx can control the VU meters, the VCI's internal soundcard always *also* controls the VU Meters. This can result in an odd flickering effect that looks strange. For this reason, the Master VU meters are disabled by default. If you've installed the firmware that allows decks C and D to act as pass-through mixer channels, you may see flickering there too.

---

## Glossario dei Termini

---

### AAC

**Advanced Audio Coding** A patented audio compression algorithm which uses a form of *lossy* data compression. Designed to be the successor to *MP3*, AAC generally achieves better sound quality at similar bit rates. While the *.aac* extension is sometimes used for AAC-encoded files, they are typically saved with an *.m4a* file extension.

**AcoustID** An acoustic fingerprint system built entirely on *open-source* technology. It aims to create a free database of user-submitted audio fingerprints with mapping to the *MusicBrainz metadata* database and provide a web service for audio file identification using this database. For more information, see [`<https://acoustid.org/>`](https://acoustid.org/).

### AIFF

**Audio Interchange File Format** High-quality digital audio file format, similar to *.wav* files. Contains CD quality audio stored in a non-compressed, *lossless* format. AIFF files generally end with a *.aiff* or *.aif* extension.

### ALAC

**Apple Lossless Audio Codec** A *lossless* audio file format used by iTunes and other Apple products. ALAC files use the same MP4 container format as AAC and use the same file extensions (*m4a*, *mp4*). Mixxx and many other programs are not compatible with ALAC. It is recommended to convert ALAC files to *FLAC* for use in Mixxx.

### API

**Application Program Interface** An API is a specification and set of rules for how software programs interact with each other. In Mixxx, an example of this is the Sound API that Mixxx uses to communicate with the *operating system* to make use of the *soundcards* connected to the computer.

### ASIO

**Audio Stream Input/Output** ASIO is a *low-latency audio interface API* on Microsoft Windows.

**audio interface** An audio interface is a device that facilitates the input and output of audio signals to and from a computer, typically connected by *USB*. Almost all computers come with a basic audio interface built in, but a higher quality audio interface with at least 4 output channels is recommended for Mixxx.

**balance** A balance control on a mixer allows you to adjust the balance between the left and right channel. The balance refers to the relative volume of the corresponding channel in a stereo audio signal.

**bar** In musical notation, a bar (or measure) is a segment of time defined by a given number of beats. Typically, a piece consists of several bars of the same length.

**beatgrid** A series of markers that point to the location of beats within the track. Beatgrids are used for advanced mixing functions such as track *sync*, precise effects synchronization, looping and accurate *BPM* representation.

**beatmatching** A mixing technique used to establish a similar tempo with two or more tracks, making them sound like just one track.

**binaries** Files that contain compiled computer code, which was compiled from source code. Source code, which is usually a bunch of text files, is processed with a program called a compiler. The compiler then generates a binary, which is something like an .exe or a .dll file. By using binaries you are relieved of the task of having to compile the code by yourself.

**bitrate** Describe the quality of an audio or video file. For audio data the bitrate is commonly measured in *kbps*. For example, an MP3 audio file that is compressed at 192 Kbps will have a greater dynamic range and may sound slightly more clear than the same audio file compressed at 128 Kbps.

## BPM

**Beats per minute** BPM is used as a measure of tempo in music. If you tap your foot to music you are following the “beat”. If you count how many taps you do in a minute you have calculated the BPM.

**bug report** Every software has bugs. When you come across a bug in this software, you should submit a report about it to the developers. They can use this to identify, replicate and fix the issue.

**CDJ** CDJ is a term originally used to describe a line of CD players from Pioneer Electronics. Today CDJ generally refers to DJ CD players that work like a record player. They allow analog control of music using CDs, usually using a touch sensitive emulated vinyl control surface.

**codec** Short for compressor/decompressor, a codec is any technology for compressing and decompressing audio and video data. Some popular codecs for computer audio include *MP3* and *Ogg Vorbis*.

**controller** An external hardware device that generates and transmits signals to a computer, usually via *USB*, to control software with physical controls other than a mouse and keyboard. Controllers have many uses for music such as controlling DJ programs like Mixxx. They typically send *MIDI* signals but some controllers use *HID* signals. Many DJs prefer to control DJ software using physical knobs, faders, and wheels on controllers instead of using a computer keyboard and mouse.

**crossfader** The crossfader is a slider that determines how much each deck of audio contributes to the *master output*.

## cue

**cue point** A reference point in the track usually placed on the position the DJ wants the track to start at by default. This is useful to instantly jump to that point without seeking through the track.

**cue sheet** A cue sheet (or CUE file, CUE sheet, etc.) is a formatted plain text file which is used to provide index information for a large audio file. For example, it can be used to tell software extra details about the layout of a CD to burn.

**cueing** Headphone cueing, or just cueing, is listening to the next track you would like to mix in your headphones. The audience will not hear what you are cueing in your headphones. Being able to cue is a crucial aspect to DJing.

## DAW

**Digital Audio Workstation** An electronic device or application software used for recording, editing and producing audio files.

## db

**decibel** A Decibel is a logarithmic measurement of sound level. Whispering is around 25 dB while unbearable sound such as a jet engine is around 160 db. Rule of thumb: A volume increase of 10 dB is perceived as twice as loud.

**deck** A deck is like a virtual vinyl turntable. You can load a *track* into it and play the track, just like you would put a record on turntable and play it.

**direct monitoring** A feature of many *soundcards* that allows microphones and other input signals to be heard through the soundcard outputs with no perceivable latency. With direct monitoring, the audio interface mixes the input signal in hardware with the output signal from Mixxx. This bypasses the latency of sending the signal into the computer for Mixxx to process and sending it back out to the soundcard.

**DRM** Digital Rights Management (DRM) technologies attempt to control what you can and can't do with the media and hardware you've purchased. Typically, a DRM system either encrypts the data so that it can only be accessed in a way authorized by copyright holders or marks content with a digital watermark or similar method so that the content can not be freely distributed. For information about how you can get involved in activism against DRM, see *Defective by Design*.

## EQ

**Equalizer** An equalizer allows the sound in specified frequency bands to be amplified or reduced, in order to adjust the quality and character of the sound.

A simple graphic equalizer consists of multiple controls for boosting or cutting bands or frequencies of sound.

A parametric equalizer controls more parameters of the sound than a graphic equalizer. It can control three aspects of each frequency: level (boost or cut), the center or primary frequency, and the bandwidth or range of each frequency.

**fast-forward** To cause something to advance at quicker than normal speed. In terms of audio software that means if you press the fast-forward button the audio will play with increased speed as long as the button is pressed. This is useful to seek through a track.

**fast-rewind** The opposite of *fast-forward*. If you press the fast-rewind button the audio will play in reverse with increased speed as long as the button is pressed.

**file manager** A computer program that organizes data files into groups and shows you where they are when you need to find them again. Popular file managers for the *operating systems* Mixxx supports are Explorer on Windows, Finder on macOS and Nautilus on GNU/Linux.

## FLAC

**Free Lossless Audio Compression** A patent-free audio compression similar to *MP3* but *lossless* (i.e. there is no loss in audio quality when used). FLAC files generally end with a .flac extension.

**flanger** A flanger is an effect that mixes the input signal with a delayed copy of itself which leads to interferences in the signal and creates a comb-filter effect. By routing the output of the effect back into the input (feedback), the effect is enhanced.

## GUI

**Graphical User Interface** It's pronounced «gooey» and it refers to a user interface based on graphics (icons, pictures and menus) instead of text. In Mixxx, it uses a mouse, keyboard, or *MIDI / HID controllers* as input devices.

**head/mix button** The head/mix button is used to control how much you mix the *master output* into your *headphone output*. This can be very useful when *cueing* a track, because you can test out how it sounds when mixed with the main mix in your headphones, before letting the audience hear the track.

**headphone button** The headphone button is used to indicate whether or not you are pre-listening to a deck or sampler in your headphones.

**headphone output** The headphone output is what you hear in your headphones.

## HID

**Human Interface Device** A part of the *USB* specification. It specifies a device class (a type of computer hardware) for human interface devices such as keyboards, mice, game controllers, and some DJ *controllers*.

**hotcue** Similar to the main *cue* point, a hotcue is a reference point in the track. DJs usually place hotcues at distinctive positions within a track such as drops, breaks or kicks and snares. Mixxx supports up to 36 hotcues.

**HSV** HSV stands for hue, saturation, and value, and is also often called HSB (B for brightness). The HSV Color Model represents color in a way more suited to the human perception of color. For example, the relationships “stronger than”, “darker than”, and “the opposite of” are easily expressed in HSV. In contrast, the representation of the hardware-oriented *RGB* model is close to what most monitors show.

**icecast** Icecast is free and *open-source* software that allows digital audio content to be broadcast to and from media player software, enabling the creation of Internet radio stations. Unlike *Shoutcast*, the software provides the ability to stream in free file formats like *Ogg Vorbis* and run your own directory server.

## IRC

**Internet Relay Chat** IRC is an online chat network. The Mixxx IRC channel was on the *FreeNode IRC Network* in the `#mixxx` channel. The channel was replaced in 2018 by the *Mixxx Zulip Chat*.

**kbps** Short for kilobits per second. Here used to measure the quality of audio data. See *bitrate*

**key** Short for «musical key» (i.e. C major).

**key lock** With key lock enabled, the tempo of the track will change but the pitch remains consistent. When unlocked, the pitch slider will speed up (or slow down) the track and the pitch will increase (or decrease) along with it.

**kill switch** A button to turn on and off individual frequency ranges within a channel, i.e. treble, mid and bass. Useful for effects where the DJ drops a track out for a period or creates room for a transition.

## LADSPA

**Linux Audio Developer’s Simple Plugin** The LADSPA *API* is a standard for handling audio filters and audio signal processing effects.

**LAME** LAME is a free software *codec* used to encode/compress audio into the *lossy MP3* file format.

**latency** Latency refers to a short period of delay (usually measured in milliseconds) between when an audio signal enters and when it emerges from a system. Being able to lower the latency as much as possible makes a huge difference in responsiveness.

**level meter** The level meter is used to show the average levels of audio signals. The level should average around the top of the green region, with the loudest parts of the music (the transients) briefly going into the yellow region. If the level meter is in the red, the signal is clipping and the gain should be turned down.

**lossless** Used when describing audio compression algorithms, a lossless algorithm is one which results in no loss in audio quality when used.

**lossy** Used when describing audio compression algorithms, a lossy algorithm is one which results in a loss in audio quality when used.

**macOS** macOS (originally named «Mac OS X» until 2012 and then «OS X» until 2016) is the current Mac operating system that officially succeeded the classic Mac OS in 2001.

**master output** The master output is the main audio output. It is what your audience hears.

**metadata** In general, any piece of information about a music file that Mixxx uses (e.g. title, artist, album, hotcue locations, loops, etc.). Various file metadata formats allow information such as the title, artist, album, and track number to be stored in the audio file itself, see <https://en.wikipedia.org/wiki/ID3>. Mixxx stores additional metadata about music files in its database, like *beatgrid*, waveform data, *hotcues*, playlists, crates, number of plays, etc.

## MIDI

**Musical Instrument Digital Interface** A digital communications language and hardware specification enabling compatible electronic instruments, sequencers, computers, etc., to communicate with each other in a network. Most DJ *controllers* use MIDI to communicate with computers.

**MP3** A patented audio compression algorithm which uses a form of *lossy* data compression. It is de-facto standard of digital audio compression for music. MP3 files generally end with a `.mp3` extension.

**MusicBrainz** A open-source music encyclopedia that collects music *metadata* and makes it available to the public. For more information, see <https://musicbrainz.org/>.

**Ogg Vorbis** A patent-free audio compression algorithm which uses a form of lossy data compression. It is designed to provide for efficient streaming and manipulation of high quality digital audio. Ogg Vorbis files generally end with a `.ogg` or `.oga` extension.

**open-source** Generically, open-source refers to a program for which the source code is available to the public for use and/or modification from its original design free of charge. Open source code is typically created as a collaborative effort in which programmers improve upon the code and share the changes within the community. Open source sprouted in the technological community as a response to proprietary software owned by corporations. For more information, see [Wikipedia](#).

**OpenGL** An *operating system* feature used to draw hardware-accelerated graphics. Mixxx uses OpenGL to draw the waveform displays and spinning vinyl widgets.

**operating system** Your operating system (OS) is the computing environment on your computer. For example, Windows, macOS, or GNU/Linux are the three operating systems that Mixxx supports.

**Opus** Opus is a totally open, royalty-free, highly versatile *lossy* audio codec. The `.opus` filename extension is recommended.

**PFL** PFL or “pre-fader listen” is the headphone signal that is not affected by the deck volume faders. This allows for pre-listening tracks in headphones by lowering the volume fader so the deck plays only to headphones but not to the audience. See also: [headphone button](#).

**phase** The phase of a track is its position relative to another track. If two tracks are *sync'd* to the same tempo and in-phase then they should be playing so that their beats are aligned.

**pitch bend** A technique used by DJs that temporarily *bends* the rate of a track up or down, usually while a button is held. This technique is usually used to make micro-adjustments to the synchronization of tracks while beatmatching. Before digital DJing, this was accomplished by dragging one’s finger alongside the turntable to slow it down or by twisting the record spindle to speed it up.

**podcast** A podcast is a feed of audio or video files made available for free or for purchase over the Internet. Podcast clients such as iTunes allow listeners to subscribe to the feed and automatically download content to their portable audio players as it becomes available.

**quantization** Quantization is the process of aligning notes and other events like loops or cuepoints so that they start or finish exactly on beats or fractions of beats.

**ramping pitch bend** Basically identical to the regular *pitch bend* with the difference that the pitch changes gradually, instead of all at once. Often uses for temporary pitch changes. It simulates the effect of touching a turntable to temporarily slow down or speed up a record.

**rate** The speed at which a track is played back, usually expressed in terms of a percentage of the speed relative to the tracks normal rate. Often while mixing, DJs adjust the rates of tracks so that they can play at the same tempo as other tracks. This allows DJs to *beatmix*, and is an essential part of DJing.

**Riapplica Gain** ReplayGain normalizes audio data in a non-destructive way, so the tracks in your music library don’t all play at different volumes. Audio files are scanned by a psychoacoustic algorithm to determine the loudness of the audio data. ReplayGain information is stored as *metadata* in a digital audio file in order for the sound to be correctly played at the right level of loudness.

**reverse** Reverse plays a track backwards.

**RGB** The RGB color model is an additive color model in which red, green, and blue light are added together in various ways to reproduce a broad array of colors. The name of the model comes from the initials of the three additive primary colors, red, green, and blue.

**shortcut** Shortcuts let you work more efficiently. This manual shows some shortcuts for accessing Mixxx functions with an English keyboard layout. Depending on your language settings the defaults may be different.

**shoutcast** Shoutcast is proprietary software that allows digital audio content to be broadcast to and from media player software, enabling the creation of Internet radio stations.

**soundcard** Another name for an *audio interface*, although few audio interfaces are shaped like cards anymore.

**sync** Sync allows you to automatically adjust a track's *tempo* and *phase* to be in sync with another deck that is playing.

#### **sync lock**

**master sync** Sync lock mode persistently adjusts a track's *tempo* and *phase* (if *quantization* is enabled) in order to stay in *sync* with other decks that are in sync lock mode.

**tempo** The speed of a track measured in *BPM*.

**timecode** Used here in conjunction with *vinyl control*. A special audio signal on a control vinyl or control CD (timecode media) that a computer can listen to in order to determine speed, direction and position of the playback.

**track** A track is another word for a song.

#### **URL**

**Uniform Resource Locator** The address that defines the route to a file on an Internet server. URLs are typed into a Web browser to access Web pages and files, and URLs are embedded within the pages themselves as hypertext links. One example of a URL is <https://mixxx.org>.

#### **USB**

**Universal Serial Bus** USB is an industry standard for cables, connectors and protocols and used for lots of consumer hardware. If an *audio interface* is «USB class compliant», this means it can be used on all major *operating systems* without special drivers (on Windows, special drivers might still be necessary to use the *ASIO* sound *API* though).

**vinyl control** A method of controlling DJ applications which simulates the traditional DJing paradigm of two turntables. Using special *timecode* media, the DJ application analyzes the timecode signal and simulates the sound and feel of having your music collection on vinyl.

**volume** A term that refers to the degree of sound intensity or audibility; loudness. Volume is determined by people's perception and does not directly correspond to any physical property of sound.

**WAV** Standard digital audio file format used for storing waveform data; allows audio recordings to be saved with different sampling rates and bitrates; often saved in a 44.1 KHz, 16-bit, stereo format, which is the standard format used for CD audio. Wave files are not compressed, and are therefore *lossless*. Wave files generally end with a *.wav* extension.

**waveform overview** The waveform overview shows the waveform envelope of the entire track, and is useful because they allow DJs to see breakdowns far in advance.

**waveform summary** The waveform summary shows the waveform envelope of the track near the current playback position.

**Zulip** *Zulip* is a powerful, open source group chat application that combines the immediacy of real-time chat with the productivity benefits of threaded conversations. The Mixxx *Zulip* Chat at can be found at <https://mixxx.zulipchat.com>.



**[AutoDJ]**

- [AutoDJ], enabled (chapters/appendix/mixxx\_controls), 165
- [AutoDJ], fade\_now (chapters/appendix/mixxx\_controls), 165
- [AutoDJ], shuffle\_playlist (chapters/appendix/mixxx\_controls), 165
- [AutoDJ], skip\_next (chapters/appendix/mixxx\_controls), 165

**[AuxiliaryN]**

- [AuxiliaryN], enabled (chapters/appendix/mixxx\_controls), 161
- [AuxiliaryN], input\_configured (chapters/appendix/mixxx\_controls), 161
- [AuxiliaryN], master (chapters/appendix/mixxx\_controls), 161
- [AuxiliaryN], mute (chapters/appendix/mixxx\_controls), 163
- [AuxiliaryN], orientation (chapters/appendix/mixxx\_controls), 162
- [AuxiliaryN], orientation\_center (chapters/appendix/mixxx\_controls), 144
- [AuxiliaryN], orientation\_left (chapters/appendix/mixxx\_controls), 144
- [AuxiliaryN], orientation\_right (chapters/appendix/mixxx\_controls), 145
- [AuxiliaryN], PeakIndicator (chapters/appendix/mixxx\_controls), 162
- [AuxiliaryN], PeakIndicatorL (chapters/appendix/mixxx\_controls), 162
- [AuxiliaryN], PeakIndicatorR (chapters/appendix/mixxx\_controls), 162
- [AuxiliaryN], pfl (chapters/appendix/mixxx\_controls), 162
- [AuxiliaryN], pregain (chapters/appendix/mixxx\_controls), 163
- [AuxiliaryN], talkover (chapters/appendix/mixxx\_controls), 163
- [AuxiliaryN], volume (chapters/appendix/mixxx\_controls), 163
- [AuxiliaryN], VuMeter (chapters/appendix/mixxx\_controls), 163
- [AuxiliaryN], VuMeterL (chapters/appendix/mixxx\_controls), 163
- [AuxiliaryN], VuMeterR (chapters/appendix/mixxx\_controls), 164

**[ChannelN]**

- [ChannelN], back (chapters/appendix/mixxx\_controls), 128
- [ChannelN], beat\_active (chapters/appendix/mixxx\_controls), 128
- [ChannelN], beat\_closest (chapters/appendix/mixxx\_controls), 128
- [ChannelN], beat\_distance (chapters/appendix/mixxx\_controls), 128
- [ChannelN], beat\_jump (chapters/appendix/mixxx\_controls), 129
- [ChannelN], beat\_jump\_backward (chapters/appendix/mixxx\_controls), 129
- [ChannelN], beat\_jump\_forward (chapters/appendix/mixxx\_controls), 129
- [ChannelN], beat\_jump\_size (chapters/appendix/mixxx\_controls), 129
- [ChannelN], beat\_jump\_X\_backward (chapters/appendix/mixxx\_controls), 129
- [ChannelN], beat\_jump\_X\_forward (chapters/appendix/mixxx\_controls), 129
- [ChannelN], beatloop (chapters/appendix/mixxx\_controls), 158
- [ChannelN], beatloop\_activate (chapters/appendix/mixxx\_controls), 130
- [ChannelN], beatloop\_size (chapters/appendix/mixxx\_controls), 130
- [ChannelN], beatloop\_X (chapters/appendix/mixxx\_controls), 160
- [ChannelN], beatloop\_X\_activate (chapters/appendix/mixxx\_controls), 130



|   |  |   |  |
|---|--|---|--|
| [ChannelN], beatloop_X_enabled<br>( <i>chapters/appendix/mixxx_controls</i> ), 130              | ( <i>chapters/appendix/mixxx_controls</i> ), 135 | [ChannelN], cue_preview<br>( <i>chapters/appendix/mixxx_controls</i> ), 135             | ( <i>chapters/appendix/mixxx_controls</i> ), 135 |
| [ChannelN], beatloop_X_toggle<br>( <i>chapters/appendix/mixxx_controls</i> ), 130               | ( <i>chapters/appendix/mixxx_controls</i> ), 135 | [ChannelN], cue_set<br>( <i>chapters/appendix/mixxx_controls</i> ), 135                 | ( <i>chapters/appendix/mixxx_controls</i> ), 135 |
| [ChannelN], beatlooproll_activate<br>( <i>chapters/appendix/mixxx_controls</i> ), 131           | ( <i>chapters/appendix/mixxx_controls</i> ), 135 | [ChannelN], cue_simple<br>( <i>chapters/appendix/mixxx_controls</i> ), 135              | ( <i>chapters/appendix/mixxx_controls</i> ), 135 |
| [ChannelN], beatlooproll_X_activate<br>( <i>chapters/appendix/mixxx_controls</i> ), 131         | ( <i>chapters/appendix/mixxx_controls</i> ), 135 | [ChannelN], duration<br>( <i>chapters/appendix/mixxx_controls</i> ), 135                | ( <i>chapters/appendix/mixxx_controls</i> ), 135 |
| [ChannelN], beats_adjust_faster<br>( <i>chapters/appendix/mixxx_controls</i> ), 131             | ( <i>chapters/appendix/mixxx_controls</i> ), 136 | [ChannelN], eject<br>( <i>chapters/appendix/mixxx_controls</i> ), 136                   | ( <i>chapters/appendix/mixxx_controls</i> ), 136 |
| [ChannelN], beats_adjust_slower<br>( <i>chapters/appendix/mixxx_controls</i> ), 131             | ( <i>chapters/appendix/mixxx_controls</i> ), 136 | [ChannelN], end ( <i>chapters/appendix/mixxx_controls</i> ),<br>136                     | ( <i>chapters/appendix/mixxx_controls</i> ), 136 |
| [ChannelN], beats_translate_curpos<br>( <i>chapters/appendix/mixxx_controls</i> ), 131          | ( <i>chapters/appendix/mixxx_controls</i> ), 136 | [ChannelN], end_of_track<br>( <i>chapters/appendix/mixxx_controls</i> ), 136            | ( <i>chapters/appendix/mixxx_controls</i> ), 136 |
| [ChannelN], beats_translate_earlier<br>( <i>chapters/appendix/mixxx_controls</i> ), 132         | ( <i>chapters/appendix/mixxx_controls</i> ), 136 | [ChannelN], file_bpm<br>( <i>chapters/appendix/mixxx_controls</i> ), 136                | ( <i>chapters/appendix/mixxx_controls</i> ), 136 |
| [ChannelN], beats_translate_later<br>( <i>chapters/appendix/mixxx_controls</i> ), 132           | ( <i>chapters/appendix/mixxx_controls</i> ), 136 | [ChannelN], file_key<br>( <i>chapters/appendix/mixxx_controls</i> ), 136                | ( <i>chapters/appendix/mixxx_controls</i> ), 136 |
| [ChannelN], beats_translate_match_alignment<br>( <i>chapters/appendix/mixxx_controls</i> ), 131 | ( <i>chapters/appendix/mixxx_controls</i> ), 159 | [ChannelN], filter<br>( <i>chapters/appendix/mixxx_controls</i> ), 159                  | ( <i>chapters/appendix/mixxx_controls</i> ), 159 |
| [ChannelN], beatsync<br>( <i>chapters/appendix/mixxx_controls</i> ), 132                        | ( <i>chapters/appendix/mixxx_controls</i> ), 159 | [ChannelN], filterDepth<br>( <i>chapters/appendix/mixxx_controls</i> ), 159             | ( <i>chapters/appendix/mixxx_controls</i> ), 159 |
| [ChannelN], beatsync_phase<br>( <i>chapters/appendix/mixxx_controls</i> ), 132                  | ( <i>chapters/appendix/mixxx_controls</i> ), 160 | [ChannelN], filterHigh<br>( <i>chapters/appendix/mixxx_controls</i> ), 160              | ( <i>chapters/appendix/mixxx_controls</i> ), 160 |
| [ChannelN], beatsync_tempo<br>( <i>chapters/appendix/mixxx_controls</i> ), 132                  | ( <i>chapters/appendix/mixxx_controls</i> ), 160 | [ChannelN], filterHighKill<br>( <i>chapters/appendix/mixxx_controls</i> ), 160          | ( <i>chapters/appendix/mixxx_controls</i> ), 160 |
| [ChannelN], bpm ( <i>chapters/appendix/mixxx_controls</i> ),<br>132                             | ( <i>chapters/appendix/mixxx_controls</i> ), 159 | [ChannelN], filterLow<br>( <i>chapters/appendix/mixxx_controls</i> ), 159               | ( <i>chapters/appendix/mixxx_controls</i> ), 159 |
| [ChannelN], bpm_tap<br>( <i>chapters/appendix/mixxx_controls</i> ), 133                         | ( <i>chapters/appendix/mixxx_controls</i> ), 159 | [ChannelN], filterLowKill<br>( <i>chapters/appendix/mixxx_controls</i> ), 159           | ( <i>chapters/appendix/mixxx_controls</i> ), 159 |
| [ChannelN], CloneFromDeck<br>( <i>chapters/appendix/mixxx_controls</i> ), 133                   | ( <i>chapters/appendix/mixxx_controls</i> ), 160 | [ChannelN], filterMid<br>( <i>chapters/appendix/mixxx_controls</i> ), 160               | ( <i>chapters/appendix/mixxx_controls</i> ), 160 |
| [ChannelN], CloneFromSampler<br>( <i>chapters/appendix/mixxx_controls</i> ), 133                | ( <i>chapters/appendix/mixxx_controls</i> ), 160 | [ChannelN], filterMidKill<br>( <i>chapters/appendix/mixxx_controls</i> ), 160           | ( <i>chapters/appendix/mixxx_controls</i> ), 160 |
| [ChannelN], cue_cdj<br>( <i>chapters/appendix/mixxx_controls</i> ), 133                         | ( <i>chapters/appendix/mixxx_controls</i> ), 177 | [ChannelN], flanger<br>( <i>chapters/appendix/mixxx_controls</i> ), 177                 | ( <i>chapters/appendix/mixxx_controls</i> ), 177 |
| [ChannelN], cue_clear<br>( <i>chapters/appendix/mixxx_controls</i> ), 133                       | ( <i>chapters/appendix/mixxx_controls</i> ), 136 | [ChannelN], fwd ( <i>chapters/appendix/mixxx_controls</i> ),<br>136                     | ( <i>chapters/appendix/mixxx_controls</i> ), 136 |
| [ChannelN], cue_default<br>( <i>chapters/appendix/mixxx_controls</i> ), 134                     | ( <i>chapters/appendix/mixxx_controls</i> ), 177 | [ChannelN], Hercules1<br>( <i>chapters/appendix/mixxx_controls</i> ), 177               | ( <i>chapters/appendix/mixxx_controls</i> ), 177 |
| [ChannelN], cue_goto<br>( <i>chapters/appendix/mixxx_controls</i> ), 134                        | ( <i>chapters/appendix/mixxx_controls</i> ), 177 | [ChannelN], Hercules2<br>( <i>chapters/appendix/mixxx_controls</i> ), 177               | ( <i>chapters/appendix/mixxx_controls</i> ), 177 |
| [ChannelN], cue_gotoandplay<br>( <i>chapters/appendix/mixxx_controls</i> ), 134                 | ( <i>chapters/appendix/mixxx_controls</i> ), 177 | [ChannelN], Hercules3<br>( <i>chapters/appendix/mixxx_controls</i> ), 177               | ( <i>chapters/appendix/mixxx_controls</i> ), 177 |
| [ChannelN], cue_gotoandstop<br>( <i>chapters/appendix/mixxx_controls</i> ), 134                 | ( <i>chapters/appendix/mixxx_controls</i> ), 177 | [ChannelN], Hercules4<br>( <i>chapters/appendix/mixxx_controls</i> ), 177               | ( <i>chapters/appendix/mixxx_controls</i> ), 177 |
| [ChannelN], cue_indicator<br>( <i>chapters/appendix/mixxx_controls</i> ), 134                   | ( <i>chapters/appendix/mixxx_controls</i> ), 138 | [ChannelN], hotcue_focus<br>( <i>chapters/appendix/mixxx_controls</i> ), 138            | ( <i>chapters/appendix/mixxx_controls</i> ), 138 |
| [ChannelN], cue_mode<br>( <i>chapters/appendix/mixxx_controls</i> ), 134                        | ( <i>chapters/appendix/mixxx_controls</i> ), 138 | [ChannelN], hotcue_focus_color_next<br>( <i>chapters/appendix/mixxx_controls</i> ), 138 | ( <i>chapters/appendix/mixxx_controls</i> ), 138 |
| [ChannelN], cue_play<br>( <i>chapters/appendix/mixxx_controls</i> ), 135                        | ( <i>chapters/appendix/mixxx_controls</i> ), 138 | [ChannelN], hotcue_focus_color_prev<br>( <i>chapters/appendix/mixxx_controls</i> ), 138 | ( <i>chapters/appendix/mixxx_controls</i> ), 138 |
| [ChannelN], cue_point<br>( <i>chapters/appendix/mixxx_controls</i> ), 135                       | ( <i>chapters/appendix/mixxx_controls</i> ), 136 | [ChannelN], hotcue_X_activate<br>( <i>chapters/appendix/mixxx_controls</i> ), 136       | ( <i>chapters/appendix/mixxx_controls</i> ), 136 |

|  |        |  |        |
|--|--------|--|--------|
| [ChannelN], hotcue_X_clear<br><i>ters/appendix/mixxx_controls</i> ), 137                 | (chap- | [ChannelN], loop_half<br><i>ters/appendix/mixxx_controls</i> ), 142            | (chap- |
| [ChannelN], hotcue_X_color<br><i>ters/appendix/mixxx_controls</i> ), 137                 | (chap- | [ChannelN], loop_in<br><i>ters/appendix/mixxx_controls</i> ), 142              | (chap- |
| [ChannelN], hotcue_X_enabled<br><i>ters/appendix/mixxx_controls</i> ), 137               | (chap- | [ChannelN], loop_in_goto<br><i>ters/appendix/mixxx_controls</i> ), 143         | (chap- |
| [ChannelN], hotcue_X_goto<br><i>ters/appendix/mixxx_controls</i> ), 137                  | (chap- | [ChannelN], loop_move<br><i>ters/appendix/mixxx_controls</i> ), 143            | (chap- |
| [ChannelN], hotcue_X_gotoandplay<br><i>ters/appendix/mixxx_controls</i> ), 137           | (chap- | [ChannelN], loop_move_X_backward<br><i>ters/appendix/mixxx_controls</i> ), 143 | (chap- |
| [ChannelN], hotcue_X_gotoandstop<br><i>ters/appendix/mixxx_controls</i> ), 138           | (chap- | [ChannelN], loop_move_X_forward<br><i>ters/appendix/mixxx_controls</i> ), 143  | (chap- |
| [ChannelN], hotcue_X_position<br><i>ters/appendix/mixxx_controls</i> ), 138              | (chap- | [ChannelN], loop_out<br><i>ters/appendix/mixxx_controls</i> ), 143             | (chap- |
| [ChannelN], hotcue_X_set<br><i>ters/appendix/mixxx_controls</i> ), 138                   | (chap- | [ChannelN], loop_out_goto<br><i>ters/appendix/mixxx_controls</i> ), 143        | (chap- |
| [ChannelN], intro_end_activate<br><i>ters/appendix/mixxx_controls</i> ), 139             | (chap- | [ChannelN], loop_scale<br><i>ters/appendix/mixxx_controls</i> ), 144           | (chap- |
| [ChannelN], intro_end_clear<br><i>ters/appendix/mixxx_controls</i> ), 139                | (chap- | [ChannelN], loop_start_position<br><i>ters/appendix/mixxx_controls</i> ), 144  | (chap- |
| [ChannelN], intro_end_enabled<br><i>ters/appendix/mixxx_controls</i> ), 139              | (chap- | [ChannelN], mute<br><i>ters/appendix/mixxx_controls</i> ), 155                 | (chap- |
| [ChannelN], intro_end_position<br><i>ters/appendix/mixxx_controls</i> ), 139             | (chap- | [ChannelN], NextTask<br><i>ters/appendix/mixxx_controls</i> ), 177             | (chap- |
| [ChannelN], intro_end_set<br><i>ters/appendix/mixxx_controls</i> ), 139                  | (chap- | [ChannelN], NextTrack<br><i>ters/appendix/mixxx_controls</i> ), 177            | (chap- |
| [ChannelN], intro_start_activate<br><i>ters/appendix/mixxx_controls</i> ), 139           | (chap- | [ChannelN], orientation<br><i>ters/appendix/mixxx_controls</i> ), 144          | (chap- |
| [ChannelN], intro_start_clear<br><i>ters/appendix/mixxx_controls</i> ), 140              | (chap- | [ChannelN], orientation_center<br><i>ters/appendix/mixxx_controls</i> ), 144   | (chap- |
| [ChannelN], intro_start_enabled<br><i>ters/appendix/mixxx_controls</i> ), 140            | (chap- | [ChannelN], orientation_left<br><i>ters/appendix/mixxx_controls</i> ), 144     | (chap- |
| [ChannelN], intro_start_position<br><i>ters/appendix/mixxx_controls</i> ), 140           | (chap- | [ChannelN], orientation_right<br><i>ters/appendix/mixxx_controls</i> ), 144    | (chap- |
| [ChannelN], intro_start_set<br><i>ters/appendix/mixxx_controls</i> ), 140                | (chap- | [ChannelN], outro_end_activate<br><i>ters/appendix/mixxx_controls</i> ), 145   | (chap- |
| [ChannelN], jog ( <i>chapters/appendix/mixxx_controls</i> ),<br>159                      |        | [ChannelN], outro_end_clear<br><i>ters/appendix/mixxx_controls</i> ), 145      | (chap- |
| [ChannelN], key ( <i>chapters/appendix/mixxx_controls</i> ),<br>140                      |        | [ChannelN], outro_end_enabled<br><i>ters/appendix/mixxx_controls</i> ), 145    | (chap- |
| [ChannelN], keylock<br><i>ters/appendix/mixxx_controls</i> ), 141                        | (chap- | [ChannelN], outro_end_position<br><i>ters/appendix/mixxx_controls</i> ), 145   | (chap- |
| [ChannelN], LoadSelectedTrack<br><i>ters/appendix/mixxx_controls</i> ), 141              | (chap- | [ChannelN], outro_end_set<br><i>ters/appendix/mixxx_controls</i> ), 145        | (chap- |
| [ChannelN], LoadSelectedTrackAndPlay<br>( <i>chapters/appendix/mixxx_controls</i> ), 141 |        | [ChannelN], outro_start_activate<br><i>ters/appendix/mixxx_controls</i> ), 145 | (chap- |
| [ChannelN], local_bpm<br><i>ters/appendix/mixxx_controls</i> ), 141                      | (chap- | [ChannelN], outro_start_clear<br><i>ters/appendix/mixxx_controls</i> ), 146    | (chap- |
| [ChannelN], loop_double<br><i>ters/appendix/mixxx_controls</i> ), 142                    | (chap- | [ChannelN], outro_start_enabled<br><i>ters/appendix/mixxx_controls</i> ), 146  | (chap- |
| [ChannelN], loop_enabled<br><i>ters/appendix/mixxx_controls</i> ), 142                   | (chap- | [ChannelN], outro_start_position<br><i>ters/appendix/mixxx_controls</i> ), 146 | (chap- |
| [ChannelN], loop_end_position<br><i>ters/appendix/mixxx_controls</i> ), 142              | (chap- | [ChannelN], outro_start_set<br><i>ters/appendix/mixxx_controls</i> ), 146      | (chap- |

|   |   |
|---|---|
| [ChannelN], passthrough<br><i>(chapters/appendix/mixxx_controls)</i> , 146          | [ChannelN], rate_temp_up_small<br><i>(chapters/appendix/mixxx_controls)</i> , 150 |
| [ChannelN], PeakIndicator<br><i>(chapters/appendix/mixxx_controls)</i> , 146        | [ChannelN], rateEngine<br><i>(chapters/appendix/mixxx_controls)</i> , 151         |
| [ChannelN], PeakIndicatorL<br><i>(chapters/appendix/mixxx_controls)</i> , 147       | [ChannelN], rateRange<br><i>(chapters/appendix/mixxx_controls)</i> , 151          |
| [ChannelN], PeakIndicatorR<br><i>(chapters/appendix/mixxx_controls)</i> , 147       | [ChannelN], rateSearch<br><i>(chapters/appendix/mixxx_controls)</i> , 151         |
| [ChannelN], pfl ( <i>chapters/appendix/mixxx_controls</i> ), 147                    | [ChannelN], reloop_andstop<br><i>(chapters/appendix/mixxx_controls)</i> , 151     |
| [ChannelN], pitch<br><i>(chapters/appendix/mixxx_controls)</i> , 147                | [ChannelN], reloop_exit<br><i>(chapters/appendix/mixxx_controls)</i> , 158        |
| [ChannelN], pitch_adjust<br><i>(chapters/appendix/mixxx_controls)</i> , 148         | [ChannelN], reloop_toggle<br><i>(chapters/appendix/mixxx_controls)</i> , 151      |
| [ChannelN], pitch_down<br><i>(chapters/appendix/mixxx_controls)</i> , 148           | [ChannelN], repeat<br><i>(chapters/appendix/mixxx_controls)</i> , 151             |
| [ChannelN], pitch_up<br><i>(chapters/appendix/mixxx_controls)</i> , 147             | [ChannelN], reset_key<br><i>(chapters/appendix/mixxx_controls)</i> , 152          |
| [ChannelN], play<br><i>(chapters/appendix/mixxx_controls)</i> , 148                 | [ChannelN], reverse<br><i>(chapters/appendix/mixxx_controls)</i> , 152            |
| [ChannelN], play_indicator<br><i>(chapters/appendix/mixxx_controls)</i> , 148       | [ChannelN], reverseroll<br><i>(chapters/appendix/mixxx_controls)</i> , 152        |
| [ChannelN], play_latched<br><i>(chapters/appendix/mixxx_controls)</i> , 148         | [ChannelN], scratch<br><i>(chapters/appendix/mixxx_controls)</i> , 159            |
| [ChannelN], play_stutter<br><i>(chapters/appendix/mixxx_controls)</i> , 149         | [ChannelN], scratch2<br><i>(chapters/appendix/mixxx_controls)</i> , 152           |
| [ChannelN], playposition<br><i>(chapters/appendix/mixxx_controls)</i> , 149         | [ChannelN], scratch2_enabled<br><i>(chapters/appendix/mixxx_controls)</i> , 152   |
| [ChannelN], pregain<br><i>(chapters/appendix/mixxx_controls)</i> , 149              | [ChannelN], slip_enabled<br><i>(chapters/appendix/mixxx_controls)</i> , 152       |
| [ChannelN], PrevTask<br><i>(chapters/appendix/mixxx_controls)</i> , 177             | [ChannelN], stars_down<br><i>(chapters/appendix/mixxx_controls)</i> , 153         |
| [ChannelN], PrevTrack<br><i>(chapters/appendix/mixxx_controls)</i> , 177            | [ChannelN], stars_up<br><i>(chapters/appendix/mixxx_controls)</i> , 153           |
| [ChannelN], quantize<br><i>(chapters/appendix/mixxx_controls)</i> , 149             | [ChannelN], start<br><i>(chapters/appendix/mixxx_controls)</i> , 153              |
| [ChannelN], rate<br><i>(chapters/appendix/mixxx_controls)</i> , 149                 | [ChannelN], start_play<br><i>(chapters/appendix/mixxx_controls)</i> , 153         |
| [ChannelN], rate_dir<br><i>(chapters/appendix/mixxx_controls)</i> , 149             | [ChannelN], start_stop<br><i>(chapters/appendix/mixxx_controls)</i> , 153         |
| [ChannelN], rate_perm_down<br><i>(chapters/appendix/mixxx_controls)</i> , 149       | [ChannelN], stop<br><i>(chapters/appendix/mixxx_controls)</i> , 153               |
| [ChannelN], rate_perm_down_small<br><i>(chapters/appendix/mixxx_controls)</i> , 150 | [ChannelN], sync_enabled<br><i>(chapters/appendix/mixxx_controls)</i> , 153       |
| [ChannelN], rate_perm_up<br><i>(chapters/appendix/mixxx_controls)</i> , 150         | [ChannelN], sync_key<br><i>(chapters/appendix/mixxx_controls)</i> , 154           |
| [ChannelN], rate_perm_up_small<br><i>(chapters/appendix/mixxx_controls)</i> , 150   | [ChannelN], sync_master<br><i>(chapters/appendix/mixxx_controls)</i> , 154        |
| [ChannelN], rate_temp_down<br><i>(chapters/appendix/mixxx_controls)</i> , 150       | [ChannelN], sync_mode<br><i>(chapters/appendix/mixxx_controls)</i> , 154          |
| [ChannelN], rate_temp_down_small<br><i>(chapters/appendix/mixxx_controls)</i> , 150 | [ChannelN], track_color<br><i>(chapters/appendix/mixxx_controls)</i> , 154        |
| [ChannelN], rate_temp_up<br><i>(chapters/appendix/mixxx_controls)</i> , 150         | [ChannelN], track_loaded<br><i>(chapters/appendix/mixxx_controls)</i> , 154       |

[ChannelN], track\_samplerate  
*ters/appendix/mixxx\_controls*), 155

[ChannelN], track\_samples  
*ters/appendix/mixxx\_controls*), 155

[ChannelN], transform  
*ters/appendix/mixxx\_controls*), 177

[ChannelN], vinylcontrol\_cueing  
*ters/appendix/mixxx\_controls*), 155

[ChannelN], vinylcontrol\_enabled  
*ters/appendix/mixxx\_controls*), 155

[ChannelN], vinylcontrol\_mode  
*ters/appendix/mixxx\_controls*), 156

[ChannelN], vinylcontrol\_status  
*ters/appendix/mixxx\_controls*), 156

[ChannelN], visual\_bpm  
*ters/appendix/mixxx\_controls*), 156

[ChannelN], visual\_key  
*ters/appendix/mixxx\_controls*), 156

[ChannelN], visual\_key\_distance  
*ters/appendix/mixxx\_controls*), 157

[ChannelN], volume  
*ters/appendix/mixxx\_controls*), 155

[ChannelN], VuMeter  
*ters/appendix/mixxx\_controls*), 157

[ChannelN], VuMeterL  
*ters/appendix/mixxx\_controls*), 157

[ChannelN], VuMeterR  
*ters/appendix/mixxx\_controls*), 157

[ChannelN], waveform\_zoom  
*ters/appendix/mixxx\_controls*), 157

[ChannelN], waveform\_zoom\_down  
*ters/appendix/mixxx\_controls*), 158

[ChannelN], waveform\_zoom\_set\_default  
*(chapters/appendix/mixxx\_controls)*, 158

[ChannelN], waveform\_zoom\_up  
*ters/appendix/mixxx\_controls*), 157

[ChannelN], wheel  
*ters/appendix/mixxx\_controls*), 158

## [Controls]

[Controls], AutoHotcueColors  
*ters/appendix/mixxx\_controls*), 171

[Controls], ShowDurationRemaining  
*ters/appendix/mixxx\_controls*), 171

[Controls], touch\_shift  
*ters/appendix/mixxx\_controls*), 171

## [EffectRack1]

[EffectRack1], clear  
*ters/appendix/mixxx\_controls*), 173

[EffectRack1], num\_effectunits  
*ters/appendix/mixxx\_controls*), 173

[EffectRack1], show  
*ters/appendix/mixxx\_controls*), 173

## (chap- [EffectRack1\_EffectUnitN]

[EffectRack1\_EffectUnitN], chain\_selector  
*(chapters/appendix/mixxx\_controls)*, 173

[EffectRack1\_EffectUnitN], clear  
*(chapters/appendix/mixxx\_controls)*, 173

[EffectRack1\_EffectUnitN], enabled  
*(chapters/appendix/mixxx\_controls)*, 173

[EffectRack1\_EffectUnitN], focused\_effect  
*(chapters/appendix/mixxx\_controls)*, 173

[EffectRack1\_EffectUnitN], group\_[ChannelI]\_enable  
*(chapters/appendix/mixxx\_controls)*, 173

[EffectRack1\_EffectUnitN], group\_[Headphone]\_enable  
*(chapters/appendix/mixxx\_controls)*, 173

[EffectRack1\_EffectUnitN], group\_[Master]\_enable  
*(chapters/appendix/mixxx\_controls)*, 173

[EffectRack1\_EffectUnitN], group\_[SamplerJ]\_enable  
*(chapters/appendix/mixxx\_controls)*, 174

[EffectRack1\_EffectUnitN], loaded  
*(chapters/appendix/mixxx\_controls)*, 174

[EffectRack1\_EffectUnitN], mix  
*(chapters/appendix/mixxx\_controls)*, 174

[EffectRack1\_EffectUnitN], next\_chain  
*(chapters/appendix/mixxx\_controls)*, 174

[EffectRack1\_EffectUnitN], num\_effects  
*(chapters/appendix/mixxx\_controls)*, 174

[EffectRack1\_EffectUnitN], num\_effectslots  
*(chapters/appendix/mixxx\_controls)*, 174

[EffectRack1\_EffectUnitN], prev\_chain  
*(chapters/appendix/mixxx\_controls)*, 174

[EffectRack1\_EffectUnitN], show\_focus  
*(chapters/appendix/mixxx\_controls)*, 174

[EffectRack1\_EffectUnitN], show\_parameters  
*(chapters/appendix/mixxx\_controls)*, 174

[EffectRack1\_EffectUnitN], super1  
*(chapters/appendix/mixxx\_controls)*, 175

## (chap- [EffectRack1\_EffectUnitN\_EffectM]

[EffectRack1\_EffectUnitN\_EffectM], button\_parameter  
*(chapters/appendix/mixxx\_controls)*, 177

[EffectRack1\_EffectUnitN\_EffectM], button\_parameter  
*(chapters/appendix/mixxx\_controls)*, 177

[EffectRack1\_EffectUnitN\_EffectM], button\_parameter  
*(chapters/appendix/mixxx\_controls)*, 177

[EffectRack1\_EffectUnitN\_EffectM], clear  
*(chapters/appendix/mixxx\_controls)*, 175

[EffectRack1\_EffectUnitN\_EffectM], effect\_selector  
*(chapters/appendix/mixxx\_controls)*, 175

[EffectRack1\_EffectUnitN\_EffectM], enabled  
*(chapters/appendix/mixxx\_controls)*, 175

[EffectRack1\_EffectUnitN\_EffectM], loaded  
*(chapters/appendix/mixxx\_controls)*, 175

[EffectRack1\_EffectUnitN\_EffectM], meta  
*(chapters/appendix/mixxx\_controls)*, 176



[EffectRack1\_EffectUnitN\_EffectM], next\_effect [EqualizerRack1\_[ChannelI]], show\_parameters  
 (chapters/appendix/mixxx\_controls), 175 (chapters/appendix/mixxx\_controls), 174

[EffectRack1\_EffectUnitN\_EffectM], num\_buttons [EqualizerRack1\_[ChannelI]], super1  
 (chapters/appendix/mixxx\_controls), 176 (chapters/appendix/mixxx\_controls), 175

[EffectRack1\_EffectUnitN\_EffectM], num\_button\_parameterslots  
 (chapters/appendix/mixxx\_controls), 176

[EffectRack1\_EffectUnitN\_EffectM], num\_parameters [EqualizerRack1\_[ChannelI]\_Effect1], button\_parameterslots  
 (chapters/appendix/mixxx\_controls), 175 (chapters/appendix/mixxx\_controls), 177

[EffectRack1\_EffectUnitN\_EffectM], num\_parameterslots [EqualizerRack1\_[ChannelI]\_Effect1], button\_parameterslots  
 (chapters/appendix/mixxx\_controls), 175 (chapters/appendix/mixxx\_controls), 177

[EffectRack1\_EffectUnitN\_EffectM], parameterK [EqualizerRack1\_[ChannelI]\_Effect1], button\_parameterslots  
 (chapters/appendix/mixxx\_controls), 176 (chapters/appendix/mixxx\_controls), 177

[EffectRack1\_EffectUnitN\_EffectM], parameterK\_link\_inverts [EqualizerRack1\_[ChannelI]\_Effect1], clear  
 (chapters/appendix/mixxx\_controls), 176 (chapters/appendix/mixxx\_controls), 175

[EffectRack1\_EffectUnitN\_EffectM], parameterK\_link\_type [EqualizerRack1\_[ChannelI]\_Effect1], effect\_selector  
 (chapters/appendix/mixxx\_controls), 176 (chapters/appendix/mixxx\_controls), 175

[EffectRack1\_EffectUnitN\_EffectM], parameterK\_loaded [EqualizerRack1\_[ChannelI]\_Effect1], enabled  
 (chapters/appendix/mixxx\_controls), 176 (chapters/appendix/mixxx\_controls), 175

[EffectRack1\_EffectUnitN\_EffectM], parameterK\_type [EqualizerRack1\_[ChannelI]\_Effect1], loaded  
 (chapters/appendix/mixxx\_controls), 176 (chapters/appendix/mixxx\_controls), 175

[EffectRack1\_EffectUnitN\_EffectM], prev\_effect [EqualizerRack1\_[ChannelI]\_Effect1], meta  
 (chapters/appendix/mixxx\_controls), 176 (chapters/appendix/mixxx\_controls), 176

## [EqualizerRack1\_[ChannelI]\_Effect1]

### [EqualizerRack1]

[EqualizerRack1], clear (chapters/appendix/mixxx\_controls), 173  
 [EqualizerRack1], num\_effectunits (chapters/appendix/mixxx\_controls), 173  
 [EqualizerRack1\_[ChannelI]], chain\_selector [EqualizerRack1\_[ChannelI]\_Effect1], next\_effect  
 (chapters/appendix/mixxx\_controls), 173 (chapters/appendix/mixxx\_controls), 175  
 [EqualizerRack1\_[ChannelI]], clear (chapters/appendix/mixxx\_controls), 173  
 [EqualizerRack1\_[ChannelI]], enabled [EqualizerRack1\_[ChannelI]\_Effect1], num\_button\_parameterslots  
 (chapters/appendix/mixxx\_controls), 173 (chapters/appendix/mixxx\_controls), 176  
 [EqualizerRack1\_[ChannelI]], focused\_effect [EqualizerRack1\_[ChannelI]\_Effect1], num\_button\_parameterslots  
 (chapters/appendix/mixxx\_controls), 173 (chapters/appendix/mixxx\_controls), 176  
 [EqualizerRack1\_[ChannelI]], group\_[ChannelI] [EqualizerRack1\_[ChannelI]\_Effect1], num\_parameterslots  
 (chapters/appendix/mixxx\_controls), 173 (chapters/appendix/mixxx\_controls), 175  
 [EqualizerRack1\_[ChannelI]], loaded [EqualizerRack1\_[ChannelI]\_Effect1], parameterK  
 (chapters/appendix/mixxx\_controls), 174 (chapters/appendix/mixxx\_controls), 176  
 [EqualizerRack1\_[ChannelI]], mix (chapters/appendix/mixxx\_controls), 174  
 [EqualizerRack1\_[ChannelI]], next\_chain [EqualizerRack1\_[ChannelI]\_Effect1], parameterK\_link\_inverts  
 (chapters/appendix/mixxx\_controls), 174 (chapters/appendix/mixxx\_controls), 176  
 [EqualizerRack1\_[ChannelI]], num\_effects [Flanger], lfoDelay (chapters/appendix/mixxx\_controls), 178  
 [EqualizerRack1\_[ChannelI]], num\_effectsslots [Flanger], lfoDepth (chapters/appendix/mixxx\_controls), 177  
 [EqualizerRack1\_[ChannelI]], prev\_chain [Flanger], lfoPeriod (chapters/appendix/mixxx\_controls), 178  
 [EqualizerRack1\_[ChannelI]], show\_focus (chapters/appendix/mixxx\_controls), 174

### [Flanger]

## [Library]

[Library], `AutoDjAddBottom` (*chapters/appendix/mixxx\_controls*), 168

[Library], `AutoDjAddTop` (*chapters/appendix/mixxx\_controls*), 168

[Library], `font_size_decrement` (*chapters/appendix/mixxx\_controls*), 168

[Library], `font_size_increment` (*chapters/appendix/mixxx\_controls*), 168

[Library], `font_size_knob` (*chapters/appendix/mixxx\_controls*), 168

[Library], `GoToItem` (*chapters/appendix/mixxx\_controls*), 167

[Library], `MoveDown` (*chapters/appendix/mixxx\_controls*), 166

[Library], `MoveFocus` (*chapters/appendix/mixxx\_controls*), 167

[Library], `MoveFocusBackward` (*chapters/appendix/mixxx\_controls*), 167

[Library], `MoveFocusForward` (*chapters/appendix/mixxx\_controls*), 167

[Library], `MoveHorizontal` (*chapters/appendix/mixxx\_controls*), 167

[Library], `MoveLeft` (*chapters/appendix/mixxx\_controls*), 166

[Library], `MoveRight` (*chapters/appendix/mixxx\_controls*), 166

[Library], `MoveUp` (*chapters/appendix/mixxx\_controls*), 166

[Library], `MoveVertical` (*chapters/appendix/mixxx\_controls*), 166

[Library], `ScrollDown` (*chapters/appendix/mixxx\_controls*), 166

[Library], `ScrollUp` (*chapters/appendix/mixxx\_controls*), 166

[Library], `ScrollVertical` (*chapters/appendix/mixxx\_controls*), 166

[Library], `show_coverart` (*chapters/appendix/mixxx\_controls*), 168

[Library], `sort_column` (*chapters/appendix/mixxx\_controls*), 168

[Library], `sort_column_toggle` (*chapters/appendix/mixxx\_controls*), 169

[Library], `sort_order` (*chapters/appendix/mixxx\_controls*), 169

[Library], `track_color_next` (*chapters/appendix/mixxx\_controls*), 170

[Library], `track_color_prev` (*chapters/appendix/mixxx\_controls*), 169

## [Master]

[Master], `audio_latency_overload` (*chapters/appendix/mixxx\_controls*), 124

[Master], `audio_latency_overload_count` (*chapters/appendix/mixxx\_controls*), 124

[Master], `audio_latency_usage` (*chapters/appendix/mixxx\_controls*), 123

[Master], `balance` (*chapters/appendix/mixxx\_controls*), 124

[Master], `booth_enabled` (*chapters/appendix/mixxx\_controls*), 124

[Master], `booth_gain` (*chapters/appendix/mixxx\_controls*), 124

[Master], `crossfader` (*chapters/appendix/mixxx\_controls*), 124

[Master], `crossfader_down` (*chapters/appendix/mixxx\_controls*), 124

[Master], `crossfader_down_small` (*chapters/appendix/mixxx\_controls*), 124

[Master], `crossfader_up` (*chapters/appendix/mixxx\_controls*), 125

[Master], `crossfader_up_small` (*chapters/appendix/mixxx\_controls*), 125

[Master], `duckStrength` (*chapters/appendix/mixxx\_controls*), 125

[Master], `enabled` (*chapters/appendix/mixxx\_controls*), 125

[Master], `gain` (*chapters/appendix/mixxx\_controls*), 125

[Master], `headEnabled` (*chapters/appendix/mixxx\_controls*), 125

[Master], `headGain` (*chapters/appendix/mixxx\_controls*), 125

[Master], `headMix` (*chapters/appendix/mixxx\_controls*), 126

[Master], `headSplit` (*chapters/appendix/mixxx\_controls*), 126

[Master], `headVolume` (*chapters/appendix/mixxx\_controls*), 128

[Master], `latency` (*chapters/appendix/mixxx\_controls*), 126

[Master], `maximize_library` (*chapters/appendix/mixxx\_controls*), 126

[Master], `num_decks` (*chapters/appendix/mixxx\_controls*), 126

[Master], `num_effectsavailable` (*chapters/appendix/mixxx\_controls*), 126

[Master], `num_preview_decks` (*chapters/appendix/mixxx\_controls*), 126

[Master], `num_samplers` (*chapters/appendix/mixxx\_controls*), 126

[Master], `PeakIndicator` (*chapters/appendix/mixxx\_controls*), 127

[Master], `PeakIndicatorL` (*chapters/appendix/mixxx\_controls*), 127

[Master], `PeakIndicatorR` (*chapters/appendix/mixxx\_controls*), 127

[Master], samplerate  
*ters/appendix/mixxx\_controls*), 127  
 [Master], talkoverDucking  
*ters/appendix/mixxx\_controls*), 127  
 [Master], volume  
*ters/appendix/mixxx\_controls*), 128  
 [Master], VuMeter  
*ters/appendix/mixxx\_controls*), 127  
 [Master], VuMeterL  
*ters/appendix/mixxx\_controls*), 127  
 [Master], VuMeterR  
*ters/appendix/mixxx\_controls*), 127

## [MicrophoneN]

[MicrophoneN], enabled  
*ters/appendix/mixxx\_controls*), 161  
 [MicrophoneN], input\_configured  
*ters/appendix/mixxx\_controls*), 161  
 [MicrophoneN], master  
*ters/appendix/mixxx\_controls*), 161  
 [MicrophoneN], mute  
*ters/appendix/mixxx\_controls*), 163  
 [MicrophoneN], orientation  
*ters/appendix/mixxx\_controls*), 162  
 [MicrophoneN], PeakIndicator  
*ters/appendix/mixxx\_controls*), 162  
 [MicrophoneN], PeakIndicatorL  
*ters/appendix/mixxx\_controls*), 162  
 [MicrophoneN], PeakIndicatorR  
*ters/appendix/mixxx\_controls*), 162  
 [MicrophoneN], pfl  
*ters/appendix/mixxx\_controls*), 162  
 [MicrophoneN], pregain  
*ters/appendix/mixxx\_controls*), 163  
 [MicrophoneN], talkover  
*ters/appendix/mixxx\_controls*), 163  
 [MicrophoneN], volume  
*ters/appendix/mixxx\_controls*), 163  
 [MicrophoneN], VuMeter  
*ters/appendix/mixxx\_controls*), 163  
 [MicrophoneN], VuMeterL  
*ters/appendix/mixxx\_controls*), 163  
 [MicrophoneN], VuMeterR  
*ters/appendix/mixxx\_controls*), 164

## [Playlist]

[Playlist], AutoDjAddBottom  
*ters/appendix/mixxx\_controls*), 168  
 [Playlist], AutoDjAddTop  
*ters/appendix/mixxx\_controls*), 168  
 [Playlist], LoadSelectedIntoFirstStopped  
*(chapters/appendix/mixxx\_controls)*, 170  
 [Playlist], SelectNextPlaylist  
*ters/appendix/mixxx\_controls*), 170

(chap- [Playlist], SelectNextTrack  
*ters/appendix/mixxx\_controls*), 171  
 (chap- [Playlist], SelectPlaylist  
*ters/appendix/mixxx\_controls*), 170  
 (chap- [Playlist], SelectPrevPlaylist  
*ters/appendix/mixxx\_controls*), 170  
 (chap- [Playlist], SelectPrevTrack  
*ters/appendix/mixxx\_controls*), 171  
 (chap- [Playlist], SelectTrackKnob  
*ters/appendix/mixxx\_controls*), 170  
 (chap- [Playlist], ToggleSelectedSidebarItem  
*(chapters/appendix/mixxx\_controls)*, 171

## [PreviewDeckN]

(chap- [PreviewDeckN], back  
*ters/appendix/mixxx\_controls*), 128  
 (chap- [PreviewDeckN], beat\_active  
*ters/appendix/mixxx\_controls*), 128  
 (chap- [PreviewDeckN], beat\_closest  
*ters/appendix/mixxx\_controls*), 128  
 (chap- [PreviewDeckN], beat\_distance  
*ters/appendix/mixxx\_controls*), 128  
 (chap- [PreviewDeckN], beat\_jump  
*ters/appendix/mixxx\_controls*), 129  
 (chap- [PreviewDeckN], beat\_jump\_backward  
*ters/appendix/mixxx\_controls*), 129  
 (chap- [PreviewDeckN], beat\_jump\_forward  
*ters/appendix/mixxx\_controls*), 129  
 (chap- [PreviewDeckN], beat\_jump\_size  
*ters/appendix/mixxx\_controls*), 129  
 (chap- [PreviewDeckN], beat\_jump\_X\_backward  
*(chapters/appendix/mixxx\_controls)*, 129  
 (chap- [PreviewDeckN], beat\_jump\_X\_forward  
*ters/appendix/mixxx\_controls*), 129  
 (chap- [PreviewDeckN], beat\_loop  
*ters/appendix/mixxx\_controls*), 158  
 (chap- [PreviewDeckN], beat\_loop\_activate  
*ters/appendix/mixxx\_controls*), 130  
 (chap- [PreviewDeckN], beat\_loop\_size  
*ters/appendix/mixxx\_controls*), 130  
 (chap- [PreviewDeckN], beat\_loop\_X  
*ters/appendix/mixxx\_controls*), 160  
 (chap- [PreviewDeckN], beat\_loop\_X\_activate  
*(chapters/appendix/mixxx\_controls)*, 130  
 [PreviewDeckN], beat\_loop\_X\_enabled  
*(chapters/appendix/mixxx\_controls)*, 130  
 (chap- [PreviewDeckN], beat\_loop\_X\_toggle  
*ters/appendix/mixxx\_controls*), 130  
 (chap- [PreviewDeckN], beat\_looproll\_activate  
*(chapters/appendix/mixxx\_controls)*, 131  
 [PreviewDeckN], beat\_looproll\_X\_activate  
*(chapters/appendix/mixxx\_controls)*, 131  
 (chap- [PreviewDeckN], beats\_adjust\_faster  
*(chapters/appendix/mixxx\_controls)*, 131

|   |   |  |
|---|---|--|
| [PreviewDeckN], beats_adjust_slower<br>( <i>chapters/appendix/mixxx_controls</i> ), 131         | [PreviewDeckN], end<br>( <i>chapters/appendix/mixxx_controls</i> ), 136                     | ( <i>chapters/appendix/mixxx_controls</i> ), 136 |
| [PreviewDeckN], beats_translate_curpos<br>( <i>chapters/appendix/mixxx_controls</i> ), 131      | [PreviewDeckN], end_of_track<br>( <i>chapters/appendix/mixxx_controls</i> ), 136            | ( <i>chapters/appendix/mixxx_controls</i> ), 136 |
| [PreviewDeckN], beats_translate_earlier<br>( <i>chapters/appendix/mixxx_controls</i> ), 132     | [PreviewDeckN], file_bpm<br>( <i>chapters/appendix/mixxx_controls</i> ), 136                | ( <i>chapters/appendix/mixxx_controls</i> ), 136 |
| [PreviewDeckN], beats_translate_later<br>( <i>chapters/appendix/mixxx_controls</i> ), 132       | [PreviewDeckN], file_key<br>( <i>chapters/appendix/mixxx_controls</i> ), 136                | ( <i>chapters/appendix/mixxx_controls</i> ), 136 |
| [PreviewDeckN], beats_translate_match_align<br>( <i>chapters/appendix/mixxx_controls</i> ), 131 | [PreviewDeckN], filter<br>( <i>chapters/appendix/mixxx_controls</i> ), 159                  | ( <i>chapters/appendix/mixxx_controls</i> ), 159 |
| [PreviewDeckN], beatsync<br>( <i>chapters/appendix/mixxx_controls</i> ), 132                    | [PreviewDeckN], filterDepth<br>( <i>chapters/appendix/mixxx_controls</i> ), 159             | ( <i>chapters/appendix/mixxx_controls</i> ), 159 |
| [PreviewDeckN], beatsync_phase<br>( <i>chapters/appendix/mixxx_controls</i> ), 132              | [PreviewDeckN], filterHigh<br>( <i>chapters/appendix/mixxx_controls</i> ), 160              | ( <i>chapters/appendix/mixxx_controls</i> ), 160 |
| [PreviewDeckN], beatsync_tempo<br>( <i>chapters/appendix/mixxx_controls</i> ), 132              | [PreviewDeckN], filterHighKill<br>( <i>chapters/appendix/mixxx_controls</i> ), 160          | ( <i>chapters/appendix/mixxx_controls</i> ), 160 |
| [PreviewDeckN], bpm<br>( <i>chapters/appendix/mixxx_controls</i> ), 132                         | [PreviewDeckN], filterLow<br>( <i>chapters/appendix/mixxx_controls</i> ), 159               | ( <i>chapters/appendix/mixxx_controls</i> ), 159 |
| [PreviewDeckN], bpm_tap<br>( <i>chapters/appendix/mixxx_controls</i> ), 133                     | [PreviewDeckN], filterLowKill<br>( <i>chapters/appendix/mixxx_controls</i> ), 159           | ( <i>chapters/appendix/mixxx_controls</i> ), 159 |
| [PreviewDeckN], CloneFromDeck<br>( <i>chapters/appendix/mixxx_controls</i> ), 133               | [PreviewDeckN], filterMid<br>( <i>chapters/appendix/mixxx_controls</i> ), 160               | ( <i>chapters/appendix/mixxx_controls</i> ), 160 |
| [PreviewDeckN], CloneFromSampler<br>( <i>chapters/appendix/mixxx_controls</i> ), 133            | [PreviewDeckN], filterMidKill<br>( <i>chapters/appendix/mixxx_controls</i> ), 160           | ( <i>chapters/appendix/mixxx_controls</i> ), 160 |
| [PreviewDeckN], cue_cdj<br>( <i>chapters/appendix/mixxx_controls</i> ), 133                     | [PreviewDeckN], fwd<br>( <i>chapters/appendix/mixxx_controls</i> ), 136                     | ( <i>chapters/appendix/mixxx_controls</i> ), 136 |
| [PreviewDeckN], cue_clear<br>( <i>chapters/appendix/mixxx_controls</i> ), 133                   | [PreviewDeckN], hotcue_focus<br>( <i>chapters/appendix/mixxx_controls</i> ), 138            | ( <i>chapters/appendix/mixxx_controls</i> ), 138 |
| [PreviewDeckN], cue_default<br>( <i>chapters/appendix/mixxx_controls</i> ), 134                 | [PreviewDeckN], hotcue_focus_color_next<br>( <i>chapters/appendix/mixxx_controls</i> ), 138 | ( <i>chapters/appendix/mixxx_controls</i> ), 138 |
| [PreviewDeckN], cue_goto<br>( <i>chapters/appendix/mixxx_controls</i> ), 134                    | [PreviewDeckN], hotcue_focus_color_prev<br>( <i>chapters/appendix/mixxx_controls</i> ), 138 | ( <i>chapters/appendix/mixxx_controls</i> ), 138 |
| [PreviewDeckN], cue_gotoandplay<br>( <i>chapters/appendix/mixxx_controls</i> ), 134             | [PreviewDeckN], hotcue_X_activate<br>( <i>chapters/appendix/mixxx_controls</i> ), 136       | ( <i>chapters/appendix/mixxx_controls</i> ), 136 |
| [PreviewDeckN], cue_gotoandstop<br>( <i>chapters/appendix/mixxx_controls</i> ), 134             | [PreviewDeckN], hotcue_X_clear<br>( <i>chapters/appendix/mixxx_controls</i> ), 137          | ( <i>chapters/appendix/mixxx_controls</i> ), 137 |
| [PreviewDeckN], cue_indicator<br>( <i>chapters/appendix/mixxx_controls</i> ), 134               | [PreviewDeckN], hotcue_X_color<br>( <i>chapters/appendix/mixxx_controls</i> ), 137          | ( <i>chapters/appendix/mixxx_controls</i> ), 137 |
| [PreviewDeckN], cue_mode<br>( <i>chapters/appendix/mixxx_controls</i> ), 134                    | [PreviewDeckN], hotcue_X_enabled<br>( <i>chapters/appendix/mixxx_controls</i> ), 137        | ( <i>chapters/appendix/mixxx_controls</i> ), 137 |
| [PreviewDeckN], cue_play<br>( <i>chapters/appendix/mixxx_controls</i> ), 135                    | [PreviewDeckN], hotcue_X_goto<br>( <i>chapters/appendix/mixxx_controls</i> ), 137           | ( <i>chapters/appendix/mixxx_controls</i> ), 137 |
| [PreviewDeckN], cue_point<br>( <i>chapters/appendix/mixxx_controls</i> ), 135                   | [PreviewDeckN], hotcue_X_gotoandplay<br>( <i>chapters/appendix/mixxx_controls</i> ), 137    | ( <i>chapters/appendix/mixxx_controls</i> ), 137 |
| [PreviewDeckN], cue_preview<br>( <i>chapters/appendix/mixxx_controls</i> ), 135                 | [PreviewDeckN], hotcue_X_gotoandstop<br>( <i>chapters/appendix/mixxx_controls</i> ), 138    | ( <i>chapters/appendix/mixxx_controls</i> ), 138 |
| [PreviewDeckN], cue_set<br>( <i>chapters/appendix/mixxx_controls</i> ), 135                     | [PreviewDeckN], hotcue_X_position<br>( <i>chapters/appendix/mixxx_controls</i> ), 138       | ( <i>chapters/appendix/mixxx_controls</i> ), 138 |
| [PreviewDeckN], cue_simple<br>( <i>chapters/appendix/mixxx_controls</i> ), 135                  | [PreviewDeckN], hotcue_X_set<br>( <i>chapters/appendix/mixxx_controls</i> ), 138            | ( <i>chapters/appendix/mixxx_controls</i> ), 138 |
| [PreviewDeckN], duration<br>( <i>chapters/appendix/mixxx_controls</i> ), 135                    | [PreviewDeckN], intro_end_activate<br>( <i>chapters/appendix/mixxx_controls</i> ), 139      | ( <i>chapters/appendix/mixxx_controls</i> ), 139 |
| [PreviewDeckN], eject<br>( <i>chapters/appendix/mixxx_controls</i> ), 136                       | [PreviewDeckN], intro_end_clear<br>( <i>chapters/appendix/mixxx_controls</i> ), 139         | ( <i>chapters/appendix/mixxx_controls</i> ), 139 |



|  |  |
|--|--|
| [PreviewDeckN], intro_end_enabled (chapters/appendix/mixxx_controls), 139        | [PreviewDeckN], mute (chapters/appendix/mixxx_controls), 155                 |
| [PreviewDeckN], intro_end_position (chapters/appendix/mixxx_controls), 139       | [PreviewDeckN], orientation (chapters/appendix/mixxx_controls), 144          |
| [PreviewDeckN], intro_end_set (chapters/appendix/mixxx_controls), 139            | [PreviewDeckN], orientation_center (chapters/appendix/mixxx_controls), 144   |
| [PreviewDeckN], intro_start_activate (chapters/appendix/mixxx_controls), 139     | [PreviewDeckN], orientation_left (chapters/appendix/mixxx_controls), 144     |
| [PreviewDeckN], intro_start_clear (chapters/appendix/mixxx_controls), 140        | [PreviewDeckN], orientation_right (chapters/appendix/mixxx_controls), 145    |
| [PreviewDeckN], intro_start_enabled (chapters/appendix/mixxx_controls), 140      | [PreviewDeckN], outro_end_activate (chapters/appendix/mixxx_controls), 145   |
| [PreviewDeckN], intro_start_position (chapters/appendix/mixxx_controls), 140     | [PreviewDeckN], outro_end_clear (chapters/appendix/mixxx_controls), 145      |
| [PreviewDeckN], intro_start_set (chapters/appendix/mixxx_controls), 140          | [PreviewDeckN], outro_end_enabled (chapters/appendix/mixxx_controls), 145    |
| [PreviewDeckN], jog (chapters/appendix/mixxx_controls), 159                      | [PreviewDeckN], outro_end_position (chapters/appendix/mixxx_controls), 145   |
| [PreviewDeckN], key (chapters/appendix/mixxx_controls), 140                      | [PreviewDeckN], outro_end_set (chapters/appendix/mixxx_controls), 145        |
| [PreviewDeckN], keylock (chapters/appendix/mixxx_controls), 141                  | [PreviewDeckN], outro_start_activate (chapters/appendix/mixxx_controls), 145 |
| [PreviewDeckN], LoadSelectedTrack (chapters/appendix/mixxx_controls), 141        | [PreviewDeckN], outro_start_clear (chapters/appendix/mixxx_controls), 146    |
| [PreviewDeckN], LoadSelectedTrackAndPlay (chapters/appendix/mixxx_controls), 141 | [PreviewDeckN], outro_start_enabled (chapters/appendix/mixxx_controls), 146  |
| [PreviewDeckN], local_bpm (chapters/appendix/mixxx_controls), 142                | [PreviewDeckN], outro_start_position (chapters/appendix/mixxx_controls), 146 |
| [PreviewDeckN], loop_double (chapters/appendix/mixxx_controls), 142              | [PreviewDeckN], outro_start_set (chapters/appendix/mixxx_controls), 146      |
| [PreviewDeckN], loop_enabled (chapters/appendix/mixxx_controls), 142             | [PreviewDeckN], passthrough (chapters/appendix/mixxx_controls), 146          |
| [PreviewDeckN], loop_end_position (chapters/appendix/mixxx_controls), 142        | [PreviewDeckN], PeakIndicator (chapters/appendix/mixxx_controls), 147        |
| [PreviewDeckN], loop_halve (chapters/appendix/mixxx_controls), 142               | [PreviewDeckN], PeakIndicatorL (chapters/appendix/mixxx_controls), 147       |
| [PreviewDeckN], loop_in (chapters/appendix/mixxx_controls), 142                  | [PreviewDeckN], PeakIndicatorR (chapters/appendix/mixxx_controls), 147       |
| [PreviewDeckN], loop_in_goto (chapters/appendix/mixxx_controls), 143             | [PreviewDeckN], pfl (chapters/appendix/mixxx_controls), 147                  |
| [PreviewDeckN], loop_move (chapters/appendix/mixxx_controls), 143                | [PreviewDeckN], pitch (chapters/appendix/mixxx_controls), 147                |
| [PreviewDeckN], loop_move_X_backward (chapters/appendix/mixxx_controls), 144     | [PreviewDeckN], pitch_adjust (chapters/appendix/mixxx_controls), 148         |
| [PreviewDeckN], loop_move_X_forward (chapters/appendix/mixxx_controls), 143      | [PreviewDeckN], pitch_down (chapters/appendix/mixxx_controls), 148           |
| [PreviewDeckN], loop_out (chapters/appendix/mixxx_controls), 143                 | [PreviewDeckN], pitch_up (chapters/appendix/mixxx_controls), 147             |
| [PreviewDeckN], loop_out_goto (chapters/appendix/mixxx_controls), 143            | [PreviewDeckN], play (chapters/appendix/mixxx_controls), 148                 |
| [PreviewDeckN], loop_scale (chapters/appendix/mixxx_controls), 144               | [PreviewDeckN], play_indicator (chapters/appendix/mixxx_controls), 148       |
| [PreviewDeckN], loop_start_position (chapters/appendix/mixxx_controls), 144      | [PreviewDeckN], play_latched (chapters/appendix/mixxx_controls), 148         |

|   |   |   |   |
|---|---|---|---|
| [PreviewDeckN], play_stutter<br><i>(chapters/appendix/mixxx_controls)</i> , 149         | (chapters/appendix/mixxx_controls), 152 | [PreviewDeckN], slip_enabled<br><i>(chapters/appendix/mixxx_controls)</i> , 152         | (chapters/appendix/mixxx_controls), 153 |
| [PreviewDeckN], playposition<br><i>(chapters/appendix/mixxx_controls)</i> , 149         | (chapters/appendix/mixxx_controls), 153 | [PreviewDeckN], stars_down<br><i>(chapters/appendix/mixxx_controls)</i> , 153           | (chapters/appendix/mixxx_controls), 153 |
| [PreviewDeckN], pregain<br><i>(chapters/appendix/mixxx_controls)</i> , 149              | (chapters/appendix/mixxx_controls), 153 | [PreviewDeckN], stars_up<br><i>(chapters/appendix/mixxx_controls)</i> , 153             | (chapters/appendix/mixxx_controls), 153 |
| [PreviewDeckN], quantize<br><i>(chapters/appendix/mixxx_controls)</i> , 149             | (chapters/appendix/mixxx_controls), 153 | [PreviewDeckN], start<br><i>(chapters/appendix/mixxx_controls)</i> , 153                | (chapters/appendix/mixxx_controls), 153 |
| [PreviewDeckN], rate<br><i>(chapters/appendix/mixxx_controls)</i> , 149                 | (chapters/appendix/mixxx_controls), 153 | [PreviewDeckN], start_play<br><i>(chapters/appendix/mixxx_controls)</i> , 153           | (chapters/appendix/mixxx_controls), 153 |
| [PreviewDeckN], rate_dir<br><i>(chapters/appendix/mixxx_controls)</i> , 149             | (chapters/appendix/mixxx_controls), 153 | [PreviewDeckN], start_stop<br><i>(chapters/appendix/mixxx_controls)</i> , 153           | (chapters/appendix/mixxx_controls), 153 |
| [PreviewDeckN], rate_perm_down<br><i>(chapters/appendix/mixxx_controls)</i> , 149       | (chapters/appendix/mixxx_controls), 153 | [PreviewDeckN], stop<br><i>(chapters/appendix/mixxx_controls)</i> , 153                 | (chapters/appendix/mixxx_controls), 153 |
| [PreviewDeckN], rate_perm_down_small<br><i>(chapters/appendix/mixxx_controls)</i> , 150 | (chapters/appendix/mixxx_controls), 154 | [PreviewDeckN], sync_enabled<br><i>(chapters/appendix/mixxx_controls)</i> , 154         | (chapters/appendix/mixxx_controls), 154 |
| [PreviewDeckN], rate_perm_up<br><i>(chapters/appendix/mixxx_controls)</i> , 150         | (chapters/appendix/mixxx_controls), 154 | [PreviewDeckN], sync_key<br><i>(chapters/appendix/mixxx_controls)</i> , 154             | (chapters/appendix/mixxx_controls), 154 |
| [PreviewDeckN], rate_perm_up_small<br><i>(chapters/appendix/mixxx_controls)</i> , 150   | (chapters/appendix/mixxx_controls), 154 | [PreviewDeckN], sync_master<br><i>(chapters/appendix/mixxx_controls)</i> , 154          | (chapters/appendix/mixxx_controls), 154 |
| [PreviewDeckN], rate_temp_down<br><i>(chapters/appendix/mixxx_controls)</i> , 150       | (chapters/appendix/mixxx_controls), 154 | [PreviewDeckN], sync_mode<br><i>(chapters/appendix/mixxx_controls)</i> , 154            | (chapters/appendix/mixxx_controls), 154 |
| [PreviewDeckN], rate_temp_down_small<br><i>(chapters/appendix/mixxx_controls)</i> , 150 | (chapters/appendix/mixxx_controls), 154 | [PreviewDeckN], track_color<br><i>(chapters/appendix/mixxx_controls)</i> , 154          | (chapters/appendix/mixxx_controls), 154 |
| [PreviewDeckN], rate_temp_up<br><i>(chapters/appendix/mixxx_controls)</i> , 150         | (chapters/appendix/mixxx_controls), 155 | [PreviewDeckN], track_loaded<br><i>(chapters/appendix/mixxx_controls)</i> , 155         | (chapters/appendix/mixxx_controls), 155 |
| [PreviewDeckN], rate_temp_up_small<br><i>(chapters/appendix/mixxx_controls)</i> , 150   | (chapters/appendix/mixxx_controls), 155 | [PreviewDeckN], track_samplerate<br><i>(chapters/appendix/mixxx_controls)</i> , 155     | (chapters/appendix/mixxx_controls), 155 |
| [PreviewDeckN], rateEngine<br><i>(chapters/appendix/mixxx_controls)</i> , 151           | (chapters/appendix/mixxx_controls), 155 | [PreviewDeckN], track_samples<br><i>(chapters/appendix/mixxx_controls)</i> , 155        | (chapters/appendix/mixxx_controls), 155 |
| [PreviewDeckN], rateRange<br><i>(chapters/appendix/mixxx_controls)</i> , 151            | (chapters/appendix/mixxx_controls), 155 | [PreviewDeckN], vinylcontrol_cueing<br><i>(chapters/appendix/mixxx_controls)</i> , 155  | (chapters/appendix/mixxx_controls), 155 |
| [PreviewDeckN], rateSearch<br><i>(chapters/appendix/mixxx_controls)</i> , 151           | (chapters/appendix/mixxx_controls), 156 | [PreviewDeckN], vinylcontrol_enabled<br><i>(chapters/appendix/mixxx_controls)</i> , 155 | (chapters/appendix/mixxx_controls), 156 |
| [PreviewDeckN], reloop_andstop<br><i>(chapters/appendix/mixxx_controls)</i> , 151       | (chapters/appendix/mixxx_controls), 156 | [PreviewDeckN], vinylcontrol_mode<br><i>(chapters/appendix/mixxx_controls)</i> , 156    | (chapters/appendix/mixxx_controls), 156 |
| [PreviewDeckN], reloop_exit<br><i>(chapters/appendix/mixxx_controls)</i> , 158          | (chapters/appendix/mixxx_controls), 156 | [PreviewDeckN], vinylcontrol_status<br><i>(chapters/appendix/mixxx_controls)</i> , 156  | (chapters/appendix/mixxx_controls), 156 |
| [PreviewDeckN], reloop_toggle<br><i>(chapters/appendix/mixxx_controls)</i> , 151        | (chapters/appendix/mixxx_controls), 156 | [PreviewDeckN], visual_bpm<br><i>(chapters/appendix/mixxx_controls)</i> , 156           | (chapters/appendix/mixxx_controls), 156 |
| [PreviewDeckN], repeat<br><i>(chapters/appendix/mixxx_controls)</i> , 151               | (chapters/appendix/mixxx_controls), 157 | [PreviewDeckN], visual_key<br><i>(chapters/appendix/mixxx_controls)</i> , 156           | (chapters/appendix/mixxx_controls), 156 |
| [PreviewDeckN], reset_key<br><i>(chapters/appendix/mixxx_controls)</i> , 152            | (chapters/appendix/mixxx_controls), 157 | [PreviewDeckN], visual_key_distance<br><i>(chapters/appendix/mixxx_controls)</i> , 157  | (chapters/appendix/mixxx_controls), 157 |
| [PreviewDeckN], reverse<br><i>(chapters/appendix/mixxx_controls)</i> , 152              | (chapters/appendix/mixxx_controls), 155 | [PreviewDeckN], volume<br><i>(chapters/appendix/mixxx_controls)</i> , 155               | (chapters/appendix/mixxx_controls), 155 |
| [PreviewDeckN], reverseroll<br><i>(chapters/appendix/mixxx_controls)</i> , 152          | (chapters/appendix/mixxx_controls), 157 | [PreviewDeckN], VuMeter<br><i>(chapters/appendix/mixxx_controls)</i> , 157              | (chapters/appendix/mixxx_controls), 157 |
| [PreviewDeckN], scratch<br><i>(chapters/appendix/mixxx_controls)</i> , 159              | (chapters/appendix/mixxx_controls), 157 | [PreviewDeckN], VuMeterL<br><i>(chapters/appendix/mixxx_controls)</i> , 157             | (chapters/appendix/mixxx_controls), 157 |
| [PreviewDeckN], scratch2<br><i>(chapters/appendix/mixxx_controls)</i> , 152             | (chapters/appendix/mixxx_controls), 157 | [PreviewDeckN], VuMeterR<br><i>(chapters/appendix/mixxx_controls)</i> , 157             | (chapters/appendix/mixxx_controls), 157 |
| [PreviewDeckN], scratch2_enabled<br><i>(chapters/appendix/mixxx_controls)</i> , 152     | (chapters/appendix/mixxx_controls), 157 | [PreviewDeckN], waveform_zoom<br><i>(chapters/appendix/mixxx_controls)</i> , 157        | (chapters/appendix/mixxx_controls), 157 |

|  |  |
|--|--|
| [PreviewDeckN], waveform_zoom_down (chapters/appendix/mixxx_controls), 158                               | [QuickEffectRack1_[ChannelI]_Effect1], effect_select (chapters/appendix/mixxx_controls), 175       |
| [PreviewDeckN], waveform_zoom_set_default (chapters/appendix/mixxx_controls), 158                        | [QuickEffectRack1_[ChannelI]_Effect1], enabled (chapters/appendix/mixxx_controls), 175             |
| [PreviewDeckN], waveform_zoom_up (chapters/appendix/mixxx_controls), 157                                 | [QuickEffectRack1_[ChannelI]_Effect1], loaded (chapters/appendix/mixxx_controls), 175              |
| [PreviewDeckN], wheel (chapters/appendix/mixxx_controls), 158  | [QuickEffectRack1_[ChannelI]_Effect1], meta (chapters/appendix/mixxx_controls), 176                |
|  | [QuickEffectRack1_[ChannelI]_Effect1], next_effect (chapters/appendix/mixxx_controls), 175         |
| <b>[QuickEffectRack1]</b>  |  |
| [QuickEffectRack1], clear (chapters/appendix/mixxx_controls), 173  | [QuickEffectRack1_[ChannelI]_Effect1], num_button_presses (chapters/appendix/mixxx_controls), 176  |
| [QuickEffectRack1], num_effectunits (chapters/appendix/mixxx_controls), 173                              | [QuickEffectRack1_[ChannelI]_Effect1], num_button_presses (chapters/appendix/mixxx_controls), 176  |
|  | [QuickEffectRack1_[ChannelI]_Effect1], num_parameter_slots (chapters/appendix/mixxx_controls), 175 |
| <b>[QuickEffectRack1_[ChannelI]]</b>   |  |
| [QuickEffectRack1_[ChannelI]], chain_selected (chapters/appendix/mixxx_controls), 173                    | [QuickEffectRack1_[ChannelI]_Effect1], num_parameter_slots (chapters/appendix/mixxx_controls), 175 |
| [QuickEffectRack1_[ChannelI]], clear (chapters/appendix/mixxx_controls), 173                             | [QuickEffectRack1_[ChannelI]_Effect1], parameterK (chapters/appendix/mixxx_controls), 176          |
| [QuickEffectRack1_[ChannelI]], enabled (chapters/appendix/mixxx_controls), 173                           | [QuickEffectRack1_[ChannelI]_Effect1], parameterK_label (chapters/appendix/mixxx_controls), 176    |
| [QuickEffectRack1_[ChannelI]], focused_effect (chapters/appendix/mixxx_controls), 173                    | [QuickEffectRack1_[ChannelI]_Effect1], parameterK_label (chapters/appendix/mixxx_controls), 176    |
| [QuickEffectRack1_[ChannelI]], group_[ChannelI]_enable (chapters/appendix/mixxx_controls), 173           | [QuickEffectRack1_[ChannelI]_Effect1], parameterK_label (chapters/appendix/mixxx_controls), 176    |
| [QuickEffectRack1_[ChannelI]], loaded (chapters/appendix/mixxx_controls), 174                            | [QuickEffectRack1_[ChannelI]_Effect1], parameterK_type (chapters/appendix/mixxx_controls), 177     |
| [QuickEffectRack1_[ChannelI]], mix (chapters/appendix/mixxx_controls), 174                               | [QuickEffectRack1_[ChannelI]_Effect1], prev_effect (chapters/appendix/mixxx_controls), 176         |
| [QuickEffectRack1_[ChannelI]], next_chain (chapters/appendix/mixxx_controls), 174                        |  |
| [QuickEffectRack1_[ChannelI]], num_effectslots (chapters/appendix/mixxx_controls), 174                   | <b>[Recording]</b>   |
| [QuickEffectRack1_[ChannelI]], num_effectslots (chapters/appendix/mixxx_controls), 174                   | [Recording], status (chapters/appendix/mixxx_controls), 165  |
| [QuickEffectRack1_[ChannelI]], prev_chain (chapters/appendix/mixxx_controls), 174                        | [Recording], toggle_recording (chapters/appendix/mixxx_controls), 165                              |
| [QuickEffectRack1_[ChannelI]], show_focus (chapters/appendix/mixxx_controls), 174                        |  |
| [QuickEffectRack1_[ChannelI]], show_parameters (chapters/appendix/mixxx_controls), 175                   | <b>[SamplerN]</b>  |
| [QuickEffectRack1_[ChannelI]], super1 (chapters/appendix/mixxx_controls), 175                            | [SamplerN], back (chapters/appendix/mixxx_controls), 128   |
|  | [SamplerN], beat_active (chapters/appendix/mixxx_controls), 128                                    |
|  | [SamplerN], beat_closest (chapters/appendix/mixxx_controls), 128                                   |
|  | [SamplerN], beat_distance (chapters/appendix/mixxx_controls), 129                                  |
| <b>[QuickEffectRack1_[ChannelI]_Effect1]</b>   | [SamplerN], beat_jump (chapters/appendix/mixxx_controls), 129                                      |
| [QuickEffectRack1_[ChannelI]_Effect1], button_beat_jump (chapters/appendix/mixxx_controls), 177          | [SamplerN], beat_jump_backward (chapters/appendix/mixxx_controls), 129                             |
| [QuickEffectRack1_[ChannelI]_Effect1], button_beat_jump_backward (chapters/appendix/mixxx_controls), 177 | [SamplerN], beat_jump_forward (chapters/appendix/mixxx_controls), 129                              |
| [QuickEffectRack1_[ChannelI]_Effect1], button_beat_jump_forward (chapters/appendix/mixxx_controls), 177  | [SamplerN], beat_jump_size (chapters/appendix/mixxx_controls), 129                                 |
| [QuickEffectRack1_[ChannelI]_Effect1], clear_samplerN (chapters/appendix/mixxx_controls), 175            |  |

|   |        |   |        |
|---|--------|---|--------|
| [SamplerN], beatjump_X_backward<br><i>ters/appendix/mixxx_controls</i> ), 129                   | (chap- | [SamplerN], cue_goto<br><i>ters/appendix/mixxx_controls</i> ), 134                      | (chap- |
| [SamplerN], beatjump_X_forward<br><i>ters/appendix/mixxx_controls</i> ), 129                    | (chap- | [SamplerN], cue_gotoandplay<br><i>ters/appendix/mixxx_controls</i> ), 134               | (chap- |
| [SamplerN], beatloop<br><i>ters/appendix/mixxx_controls</i> ), 158                              | (chap- | [SamplerN], cue_gotoandstop<br><i>ters/appendix/mixxx_controls</i> ), 134               | (chap- |
| [SamplerN], beatloop_activate<br><i>ters/appendix/mixxx_controls</i> ), 130                     | (chap- | [SamplerN], cue_indicator<br><i>ters/appendix/mixxx_controls</i> ), 134                 | (chap- |
| [SamplerN], beatloop_size<br><i>ters/appendix/mixxx_controls</i> ), 130                         | (chap- | [SamplerN], cue_mode<br><i>ters/appendix/mixxx_controls</i> ), 134                      | (chap- |
| [SamplerN], beatloop_X<br><i>ters/appendix/mixxx_controls</i> ), 160                            | (chap- | [SamplerN], cue_play<br><i>ters/appendix/mixxx_controls</i> ), 135                      | (chap- |
| [SamplerN], beatloop_X_activate<br><i>ters/appendix/mixxx_controls</i> ), 130                   | (chap- | [SamplerN], cue_point<br><i>ters/appendix/mixxx_controls</i> ), 135                     | (chap- |
| [SamplerN], beatloop_X_enabled<br><i>ters/appendix/mixxx_controls</i> ), 130                    | (chap- | [SamplerN], cue_preview<br><i>ters/appendix/mixxx_controls</i> ), 135                   | (chap- |
| [SamplerN], beatloop_X_toggle<br><i>ters/appendix/mixxx_controls</i> ), 130                     | (chap- | [SamplerN], cue_set<br><i>ters/appendix/mixxx_controls</i> ), 135                       | (chap- |
| [SamplerN], beatlooproll_activate<br><i>ters/appendix/mixxx_controls</i> ), 131                 | (chap- | [SamplerN], cue_simple<br><i>ters/appendix/mixxx_controls</i> ), 135                    | (chap- |
| [SamplerN], beatlooproll_X_activate<br><i>(chapters/appendix/mixxx_controls)</i> ), 131         |        | [SamplerN], duration<br><i>ters/appendix/mixxx_controls</i> ), 135                      | (chap- |
| [SamplerN], beats_adjust_faster<br><i>ters/appendix/mixxx_controls</i> ), 131                   | (chap- | [SamplerN], eject<br><i>ters/appendix/mixxx_controls</i> ), 136                         | (chap- |
| [SamplerN], beats_adjust_slower<br><i>ters/appendix/mixxx_controls</i> ), 131                   | (chap- | [SamplerN], end ( <i>chapters/appendix/mixxx_controls</i> ),<br>136                     |        |
| [SamplerN], beats_translate_curpos<br><i>ters/appendix/mixxx_controls</i> ), 131                | (chap- | [SamplerN], end_of_track<br><i>ters/appendix/mixxx_controls</i> ), 136                  | (chap- |
| [SamplerN], beats_translate_earlier<br><i>(chapters/appendix/mixxx_controls)</i> ), 132         |        | [SamplerN], file_bpm<br><i>ters/appendix/mixxx_controls</i> ), 136                      | (chap- |
| [SamplerN], beats_translate_later<br><i>ters/appendix/mixxx_controls</i> ), 132                 | (chap- | [SamplerN], file_key<br><i>ters/appendix/mixxx_controls</i> ), 136                      | (chap- |
| [SamplerN], beats_translate_match_alignment<br><i>(chapters/appendix/mixxx_controls)</i> ), 131 |        | [SamplerN], filter<br><i>ters/appendix/mixxx_controls</i> ), 159                        | (chap- |
| [SamplerN], beatsync<br><i>ters/appendix/mixxx_controls</i> ), 132                              | (chap- | [SamplerN], filterDepth<br><i>ters/appendix/mixxx_controls</i> ), 159                   | (chap- |
| [SamplerN], beatsync_phase<br><i>ters/appendix/mixxx_controls</i> ), 132                        | (chap- | [SamplerN], filterHigh<br><i>ters/appendix/mixxx_controls</i> ), 160                    | (chap- |
| [SamplerN], beatsync_tempo<br><i>ters/appendix/mixxx_controls</i> ), 132                        | (chap- | [SamplerN], filterHighKill<br><i>ters/appendix/mixxx_controls</i> ), 160                | (chap- |
| [SamplerN], bpm ( <i>chapters/appendix/mixxx_controls</i> ),<br>132                             |        | [SamplerN], filterLow<br><i>ters/appendix/mixxx_controls</i> ), 159                     | (chap- |
| [SamplerN], bpm_tap<br><i>ters/appendix/mixxx_controls</i> ), 133                               | (chap- | [SamplerN], filterLowKill<br><i>ters/appendix/mixxx_controls</i> ), 159                 | (chap- |
| [SamplerN], CloneFromDeck<br><i>ters/appendix/mixxx_controls</i> ), 133                         | (chap- | [SamplerN], filterMid<br><i>ters/appendix/mixxx_controls</i> ), 160                     | (chap- |
| [SamplerN], CloneFromSampler<br><i>ters/appendix/mixxx_controls</i> ), 133                      | (chap- | [SamplerN], filterMidKill<br><i>ters/appendix/mixxx_controls</i> ), 160                 | (chap- |
| [SamplerN], cue_cdj<br><i>ters/appendix/mixxx_controls</i> ), 133                               | (chap- | [SamplerN], fwd ( <i>chapters/appendix/mixxx_controls</i> ),<br>136                     |        |
| [SamplerN], cue_clear<br><i>ters/appendix/mixxx_controls</i> ), 133                             | (chap- | [SamplerN], hotcue_focus<br><i>ters/appendix/mixxx_controls</i> ), 138                  | (chap- |
| [SamplerN], cue_default<br><i>ters/appendix/mixxx_controls</i> ), 134                           | (chap- | [SamplerN], hotcue_focus_color_next<br><i>(chapters/appendix/mixxx_controls)</i> ), 138 |        |



|  |  |
|--|--|
| [SamplerN], hotcue_focus_color_prev<br>( <i>chapters/appendix/mixxx_controls</i> ), 138  | [SamplerN], loop_enabled<br>( <i>chapters/appendix/mixxx_controls</i> ), 142         |
| [SamplerN], hotcue_X_activate<br>( <i>chapters/appendix/mixxx_controls</i> ), 136        | [SamplerN], loop_end_position<br>( <i>chapters/appendix/mixxx_controls</i> ), 142    |
| [SamplerN], hotcue_X_clear<br>( <i>chapters/appendix/mixxx_controls</i> ), 137           | [SamplerN], loop_half<br>( <i>chapters/appendix/mixxx_controls</i> ), 142            |
| [SamplerN], hotcue_X_color<br>( <i>chapters/appendix/mixxx_controls</i> ), 137           | [SamplerN], loop_in<br>( <i>chapters/appendix/mixxx_controls</i> ), 142              |
| [SamplerN], hotcue_X_enabled<br>( <i>chapters/appendix/mixxx_controls</i> ), 137         | [SamplerN], loop_in_goto<br>( <i>chapters/appendix/mixxx_controls</i> ), 143         |
| [SamplerN], hotcue_X_goto<br>( <i>chapters/appendix/mixxx_controls</i> ), 137            | [SamplerN], loop_move<br>( <i>chapters/appendix/mixxx_controls</i> ), 143            |
| [SamplerN], hotcue_X_gotoandplay<br>( <i>chapters/appendix/mixxx_controls</i> ), 137     | [SamplerN], loop_move_X_backward<br>( <i>chapters/appendix/mixxx_controls</i> ), 144 |
| [SamplerN], hotcue_X_gotoandstop<br>( <i>chapters/appendix/mixxx_controls</i> ), 138     | [SamplerN], loop_move_X_forward<br>( <i>chapters/appendix/mixxx_controls</i> ), 143  |
| [SamplerN], hotcue_X_position<br>( <i>chapters/appendix/mixxx_controls</i> ), 138        | [SamplerN], loop_out<br>( <i>chapters/appendix/mixxx_controls</i> ), 143             |
| [SamplerN], hotcue_X_set<br>( <i>chapters/appendix/mixxx_controls</i> ), 138             | [SamplerN], loop_out_goto<br>( <i>chapters/appendix/mixxx_controls</i> ), 143        |
| [SamplerN], intro_end_activate<br>( <i>chapters/appendix/mixxx_controls</i> ), 139       | [SamplerN], loop_scale<br>( <i>chapters/appendix/mixxx_controls</i> ), 144           |
| [SamplerN], intro_end_clear<br>( <i>chapters/appendix/mixxx_controls</i> ), 139          | [SamplerN], loop_start_position<br>( <i>chapters/appendix/mixxx_controls</i> ), 144  |
| [SamplerN], intro_end_enabled<br>( <i>chapters/appendix/mixxx_controls</i> ), 139        | [SamplerN], mute<br>( <i>chapters/appendix/mixxx_controls</i> ), 155                 |
| [SamplerN], intro_end_position<br>( <i>chapters/appendix/mixxx_controls</i> ), 139       | [SamplerN], orientation<br>( <i>chapters/appendix/mixxx_controls</i> ), 144          |
| [SamplerN], intro_end_set<br>( <i>chapters/appendix/mixxx_controls</i> ), 139            | [SamplerN], orientation_center<br>( <i>chapters/appendix/mixxx_controls</i> ), 144   |
| [SamplerN], intro_start_activate<br>( <i>chapters/appendix/mixxx_controls</i> ), 139     | [SamplerN], orientation_left<br>( <i>chapters/appendix/mixxx_controls</i> ), 144     |
| [SamplerN], intro_start_clear<br>( <i>chapters/appendix/mixxx_controls</i> ), 140        | [SamplerN], orientation_right<br>( <i>chapters/appendix/mixxx_controls</i> ), 145    |
| [SamplerN], intro_start_enabled<br>( <i>chapters/appendix/mixxx_controls</i> ), 140      | [SamplerN], outro_end_activate<br>( <i>chapters/appendix/mixxx_controls</i> ), 145   |
| [SamplerN], intro_start_position<br>( <i>chapters/appendix/mixxx_controls</i> ), 140     | [SamplerN], outro_end_clear<br>( <i>chapters/appendix/mixxx_controls</i> ), 145      |
| [SamplerN], intro_start_set<br>( <i>chapters/appendix/mixxx_controls</i> ), 140          | [SamplerN], outro_end_enabled<br>( <i>chapters/appendix/mixxx_controls</i> ), 145    |
| [SamplerN], jog ( <i>chapters/appendix/mixxx_controls</i> ), 159                         | [SamplerN], outro_end_position<br>( <i>chapters/appendix/mixxx_controls</i> ), 145   |
| [SamplerN], key ( <i>chapters/appendix/mixxx_controls</i> ), 140                         | [SamplerN], outro_end_set<br>( <i>chapters/appendix/mixxx_controls</i> ), 145        |
| [SamplerN], keylock ( <i>chapters/appendix/mixxx_controls</i> ), 141                     | [SamplerN], outro_start_activate<br>( <i>chapters/appendix/mixxx_controls</i> ), 145 |
| [SamplerN], LoadSelectedTrack<br>( <i>chapters/appendix/mixxx_controls</i> ), 141        | [SamplerN], outro_start_clear<br>( <i>chapters/appendix/mixxx_controls</i> ), 146    |
| [SamplerN], LoadSelectedTrackAndPlay<br>( <i>chapters/appendix/mixxx_controls</i> ), 141 | [SamplerN], outro_start_enabled<br>( <i>chapters/appendix/mixxx_controls</i> ), 146  |
| [SamplerN], local_bpm ( <i>chapters/appendix/mixxx_controls</i> ), 142                   | [SamplerN], outro_start_position<br>( <i>chapters/appendix/mixxx_controls</i> ), 146 |
| [SamplerN], loop_double ( <i>chapters/appendix/mixxx_controls</i> ), 142                 | [SamplerN], outro_start_set<br>( <i>chapters/appendix/mixxx_controls</i> ), 146      |

|   |   |   |   |
|---|---|---|---|
| [SamplerN], passthrough<br><i>(chapters/appendix/mixxx_controls)</i> , 146          | (chapters/appendix/mixxx_controls), 151 | [SamplerN], rateRange<br><i>(chapters/appendix/mixxx_controls)</i> , 151        | (chapters/appendix/mixxx_controls), 151 |
| [SamplerN], PeakIndicator<br><i>(chapters/appendix/mixxx_controls)</i> , 147        | (chapters/appendix/mixxx_controls), 151 | [SamplerN], rateSearch<br><i>(chapters/appendix/mixxx_controls)</i> , 151       | (chapters/appendix/mixxx_controls), 151 |
| [SamplerN], PeakIndicatorL<br><i>(chapters/appendix/mixxx_controls)</i> , 147       | (chapters/appendix/mixxx_controls), 151 | [SamplerN], reloop_andstop<br><i>(chapters/appendix/mixxx_controls)</i> , 151   | (chapters/appendix/mixxx_controls), 151 |
| [SamplerN], PeakIndicatorR<br><i>(chapters/appendix/mixxx_controls)</i> , 147       | (chapters/appendix/mixxx_controls), 158 | [SamplerN], reloop_exit<br><i>(chapters/appendix/mixxx_controls)</i> , 158      | (chapters/appendix/mixxx_controls), 158 |
| [SamplerN], pfl ( <i>chapters/appendix/mixxx_controls</i> ), 147                    | (chapters/appendix/mixxx_controls), 151 | [SamplerN], reloop_toggle<br><i>(chapters/appendix/mixxx_controls)</i> , 151    | (chapters/appendix/mixxx_controls), 151 |
| [SamplerN], pitch<br><i>(chapters/appendix/mixxx_controls)</i> , 147                | (chapters/appendix/mixxx_controls), 151 | [SamplerN], repeat<br><i>(chapters/appendix/mixxx_controls)</i> , 151           | (chapters/appendix/mixxx_controls), 151 |
| [SamplerN], pitch_adjust<br><i>(chapters/appendix/mixxx_controls)</i> , 148         | (chapters/appendix/mixxx_controls), 152 | [SamplerN], reset_key<br><i>(chapters/appendix/mixxx_controls)</i> , 152        | (chapters/appendix/mixxx_controls), 152 |
| [SamplerN], pitch_down<br><i>(chapters/appendix/mixxx_controls)</i> , 148           | (chapters/appendix/mixxx_controls), 152 | [SamplerN], reverse<br><i>(chapters/appendix/mixxx_controls)</i> , 152          | (chapters/appendix/mixxx_controls), 152 |
| [SamplerN], pitch_up<br><i>(chapters/appendix/mixxx_controls)</i> , 148             | (chapters/appendix/mixxx_controls), 152 | [SamplerN], reverseroll<br><i>(chapters/appendix/mixxx_controls)</i> , 152      | (chapters/appendix/mixxx_controls), 152 |
| [SamplerN], play<br><i>(chapters/appendix/mixxx_controls)</i> , 148                 | (chapters/appendix/mixxx_controls), 159 | [SamplerN], scratch<br><i>(chapters/appendix/mixxx_controls)</i> , 159          | (chapters/appendix/mixxx_controls), 159 |
| [SamplerN], play_indicator<br><i>(chapters/appendix/mixxx_controls)</i> , 148       | (chapters/appendix/mixxx_controls), 152 | [SamplerN], scratch2<br><i>(chapters/appendix/mixxx_controls)</i> , 152         | (chapters/appendix/mixxx_controls), 152 |
| [SamplerN], play_latched<br><i>(chapters/appendix/mixxx_controls)</i> , 148         | (chapters/appendix/mixxx_controls), 152 | [SamplerN], scratch2_enabled<br><i>(chapters/appendix/mixxx_controls)</i> , 152 | (chapters/appendix/mixxx_controls), 152 |
| [SamplerN], play_stutter<br><i>(chapters/appendix/mixxx_controls)</i> , 149         | (chapters/appendix/mixxx_controls), 152 | [SamplerN], slip_enabled<br><i>(chapters/appendix/mixxx_controls)</i> , 152     | (chapters/appendix/mixxx_controls), 152 |
| [SamplerN], playposition<br><i>(chapters/appendix/mixxx_controls)</i> , 149         | (chapters/appendix/mixxx_controls), 153 | [SamplerN], stars_down<br><i>(chapters/appendix/mixxx_controls)</i> , 153       | (chapters/appendix/mixxx_controls), 153 |
| [SamplerN], pregain<br><i>(chapters/appendix/mixxx_controls)</i> , 149              | (chapters/appendix/mixxx_controls), 153 | [SamplerN], stars_up<br><i>(chapters/appendix/mixxx_controls)</i> , 153         | (chapters/appendix/mixxx_controls), 153 |
| [SamplerN], quantize<br><i>(chapters/appendix/mixxx_controls)</i> , 149             | (chapters/appendix/mixxx_controls), 153 | [SamplerN], start<br><i>(chapters/appendix/mixxx_controls)</i> , 153            | (chapters/appendix/mixxx_controls), 153 |
| [SamplerN], rate<br><i>(chapters/appendix/mixxx_controls)</i> , 149                 | (chapters/appendix/mixxx_controls), 153 | [SamplerN], start_play<br><i>(chapters/appendix/mixxx_controls)</i> , 153       | (chapters/appendix/mixxx_controls), 153 |
| [SamplerN], rate_dir<br><i>(chapters/appendix/mixxx_controls)</i> , 149             | (chapters/appendix/mixxx_controls), 153 | [SamplerN], start_stop<br><i>(chapters/appendix/mixxx_controls)</i> , 153       | (chapters/appendix/mixxx_controls), 153 |
| [SamplerN], rate_perm_down<br><i>(chapters/appendix/mixxx_controls)</i> , 150       | (chapters/appendix/mixxx_controls), 153 | [SamplerN], stop<br><i>(chapters/appendix/mixxx_controls)</i> , 153             | (chapters/appendix/mixxx_controls), 153 |
| [SamplerN], rate_perm_down_small<br><i>(chapters/appendix/mixxx_controls)</i> , 150 | (chapters/appendix/mixxx_controls), 154 | [SamplerN], sync_enabled<br><i>(chapters/appendix/mixxx_controls)</i> , 154     | (chapters/appendix/mixxx_controls), 154 |
| [SamplerN], rate_perm_up<br><i>(chapters/appendix/mixxx_controls)</i> , 150         | (chapters/appendix/mixxx_controls), 154 | [SamplerN], sync_key<br><i>(chapters/appendix/mixxx_controls)</i> , 154         | (chapters/appendix/mixxx_controls), 154 |
| [SamplerN], rate_perm_up_small<br><i>(chapters/appendix/mixxx_controls)</i> , 150   | (chapters/appendix/mixxx_controls), 154 | [SamplerN], sync_master<br><i>(chapters/appendix/mixxx_controls)</i> , 154      | (chapters/appendix/mixxx_controls), 154 |
| [SamplerN], rate_temp_down<br><i>(chapters/appendix/mixxx_controls)</i> , 150       | (chapters/appendix/mixxx_controls), 154 | [SamplerN], sync_mode<br><i>(chapters/appendix/mixxx_controls)</i> , 154        | (chapters/appendix/mixxx_controls), 154 |
| [SamplerN], rate_temp_down_small<br><i>(chapters/appendix/mixxx_controls)</i> , 150 | (chapters/appendix/mixxx_controls), 154 | [SamplerN], track_color<br><i>(chapters/appendix/mixxx_controls)</i> , 154      | (chapters/appendix/mixxx_controls), 154 |
| [SamplerN], rate_temp_up<br><i>(chapters/appendix/mixxx_controls)</i> , 150         | (chapters/appendix/mixxx_controls), 155 | [SamplerN], track_loaded<br><i>(chapters/appendix/mixxx_controls)</i> , 155     | (chapters/appendix/mixxx_controls), 155 |
| [SamplerN], rate_temp_up_small<br><i>(chapters/appendix/mixxx_controls)</i> , 150   | (chapters/appendix/mixxx_controls), 155 | [SamplerN], track_samplerate<br><i>(chapters/appendix/mixxx_controls)</i> , 155 | (chapters/appendix/mixxx_controls), 155 |
| [SamplerN], rateEngine<br><i>(chapters/appendix/mixxx_controls)</i> , 151           | (chapters/appendix/mixxx_controls), 155 | [SamplerN], track_samples<br><i>(chapters/appendix/mixxx_controls)</i> , 155    | (chapters/appendix/mixxx_controls), 155 |

|  |   |
|--|---|
| [SamplerN], vinylcontrol_cueing<br><i>(chapters/appendix/mixxx_controls)</i> , 156       | [VinylControl], Toggle<br><i>(chapters/appendix/mixxx_controls)</i> , 164 |
| [SamplerN], vinylcontrol_enabled<br><i>(chapters/appendix/mixxx_controls)</i> , 155      |   |
| [SamplerN], vinylcontrol_mode<br><i>(chapters/appendix/mixxx_controls)</i> , 156         |   |
| [SamplerN], vinylcontrol_status<br><i>(chapters/appendix/mixxx_controls)</i> , 156       |   |
| [SamplerN], visual_bpm<br><i>(chapters/appendix/mixxx_controls)</i> , 156                |   |
| [SamplerN], visual_key<br><i>(chapters/appendix/mixxx_controls)</i> , 156                |   |
| [SamplerN], visual_key_distance<br><i>(chapters/appendix/mixxx_controls)</i> , 157       |   |
| [SamplerN], volume<br><i>(chapters/appendix/mixxx_controls)</i> , 155                    |   |
| [SamplerN], VuMeter<br><i>(chapters/appendix/mixxx_controls)</i> , 157                   |   |
| [SamplerN], VuMeterL<br><i>(chapters/appendix/mixxx_controls)</i> , 157                  |   |
| [SamplerN], VuMeterR<br><i>(chapters/appendix/mixxx_controls)</i> , 157                  |   |
| [SamplerN], waveform_zoom<br><i>(chapters/appendix/mixxx_controls)</i> , 157             |   |
| [SamplerN], waveform_zoom_down<br><i>(chapters/appendix/mixxx_controls)</i> , 158        |   |
| [SamplerN], waveform_zoom_set_default<br><i>(chapters/appendix/mixxx_controls)</i> , 158 |   |
| [SamplerN], waveform_zoom_up<br><i>(chapters/appendix/mixxx_controls)</i> , 157          |   |
| [SamplerN], wheel<br><i>(chapters/appendix/mixxx_controls)</i> , 158                     |   |
| <b>[Sampler]</b>   |   |
| [Sampler], LoadSamplerBank<br><i>(chapters/appendix/mixxx_controls)</i> , 161            |   |
| [Sampler], SaveSamplerBank<br><i>(chapters/appendix/mixxx_controls)</i> , 161            |   |
| <b>[Samplers]</b>  |   |
| [Samplers], show_samplers<br><i>(chapters/appendix/mixxx_controls)</i> , 161             |   |
| <b>[Shoutcast]</b>   |   |
| [Shoutcast], enabled<br><i>(chapters/appendix/mixxx_controls)</i> , 170                  |   |
| [Shoutcast], status<br><i>(chapters/appendix/mixxx_controls)</i> , 170                   |   |
| <b>[VinylControl]</b>  |   |
| [VinylControl], gain<br><i>(chapters/appendix/mixxx_controls)</i> , 164                  |   |
| [VinylControl], show_vinylcontrol<br><i>(chapters/appendix/mixxx_controls)</i> , 164     |   |

## A

AAC, **480**  
 AcoustID, **480**  
 Advanced Audio Coding, **480**  
 AIFF, **480**  
 ALAC, **480**  
 API, **480**  
 Apple Lossless Audio Codec, **480**  
 Application Program Interface, **480**  
 ASIO, **480**  
 Audio Interchange File Format, **480**  
 audio interface, **480**  
 Audio Stream Input/Output, **480**

## B

balance, **480**  
 bar, **481**  
 beatgrid, **481**  
 beatmatching, **481**  
 Beats per minute, **481**  
 binaries, **481**  
 bitrate, **481**  
 BPM, **481**  
 bug report, **481**

## C

CDJ, **481**  
 codec, **481**  
 controller, **481**  
 crossfader, **481**  
 cue, **481**  
 cue point, **481**  
 cue sheet, **481**  
 cueing, **481**

## D

DAW, **481**  
 db, **481**  
 decibel, **481**

deck, **482**  
 Digital Audio Workstation, **481**  
 direct monitoring, **482**  
 DRM, **482**

## E

EQ, **482**  
 Equalizer, **482**

## F

fast-forward, **482**  
 fast-rewind, **482**  
 file manager, **482**  
 FLAC, **482**  
 flanger, **482**  
 Free Lossless Audio Compression, **482**

## G

Graphical User Interface, **482**  
 GUI, **482**

## H

head/mix button, **482**  
 headphone button, **482**  
 headphone output, **482**  
 HID, **482**  
 hotcue, **483**  
 HSV, **483**  
 Human Interface Device, **482**

## I

icecast, **483**  
 Internet Relay Chat, **483**  
 IRC, **483**

## K

kbps, **483**  
 key, **483**  
 key lock, **483**



kill switch, [483](#)

## L

LADSPA, [483](#)

LAME, [483](#)

latency, [483](#)

level meter, [483](#)

Linux Audio Developer's Simple Plugin, [483](#)

lossless, [483](#)

lossy, [483](#)

## M

macOS, [483](#)

master output, [483](#)

master sync, [485](#)

metadata, [483](#)

MIDI, [483](#)

MP3, [484](#)

Musical Instrument Digital Interface, [483](#)

MusicBrainz, [484](#)

## O

Ogg Vorbis, [484](#)

open-source, [484](#)

OpenGL, [484](#)

operating system, [484](#)

Opus, [484](#)

## P

PFL, [484](#)

phase, [484](#)

pitch bend, [484](#)

podcast, [484](#)

## Q

quantization, [484](#)

## R

ramping pitch bend, [484](#)

rate, [484](#)

reverse, [484](#)

RGB, [484](#)

Riapplica Gain, [484](#)

## S

shortcut, [485](#)

shoutcast, [485](#)

soundcard, [485](#)

sync, [485](#)

sync lock, [485](#)

## T

tempo, [485](#)

timecode, [485](#)

track, [485](#)

## U

Uniform Resource Locator, [485](#)

Universal Serial Bus, [485](#)

URL, [485](#)

USB, [485](#)

## V

vinyl control, [485](#)

volume, [485](#)

## W

WAV, [485](#)

waveform overview, [485](#)

waveform summary, [485](#)

## Z

Zulip, [485](#)